



JONNESWAY®

Una herramienta para la vida



*de profesionales
para profesionales*

2022



JONNESWAY®

Herramientas Profesionales Manuales y Neumáticas

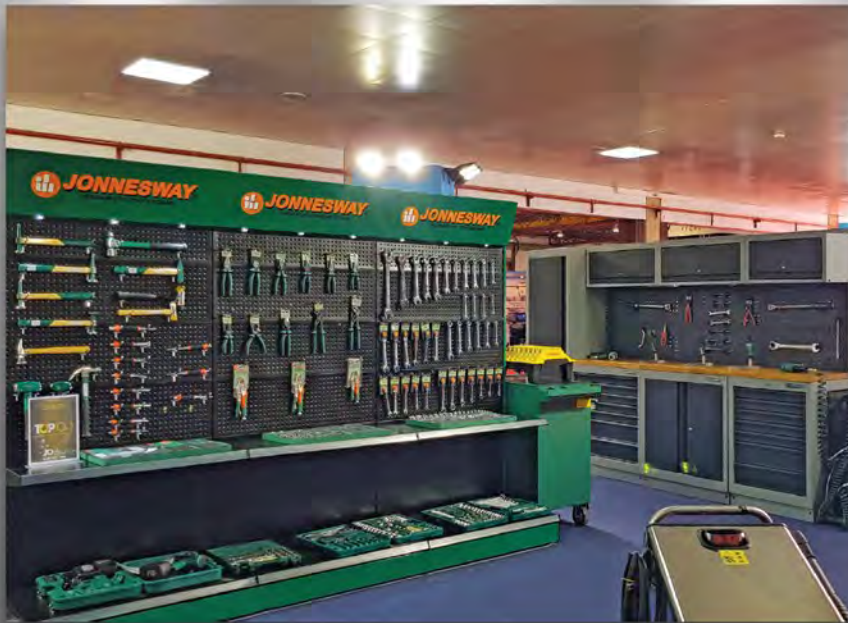

Este catálogo reemplaza a todas las ediciones anteriores.
Estos precios están sujetos a IVA o tasa legal en vigor.

Jonnesway está desarrollando constantemente sus productos, por tanto, sus modelos, composiciones, características técnicas, físicas, diseño y precios se pueden cambiar, sustituir y eliminar de este catálogo sin previo aviso y sin obligación de realizar ningún cambio en las herramientas y/o el equipo vendido previamente. Las capacidades indicadas para los productos son los resultados de las pruebas realizadas en los laboratorios Jonnesway. Por tanto no son contractuales.



www.jonneswaytools.com



















facebook.com/jonneswaytools



Lusilectra
Salvador Caetano

Versión 3.5
Entrará en vigor en enero de 2022

Carros y Composiciones de Herramientas	Carros y composiciones de herramientas	5-17	
	Armarios y carros para herramienta	18-22	
	Cajas vacías y accesorios para carros	23-25	
Herramientas Manuales	Tableros para herramienta	28-43	
	Herramienta manual	44-87	
	Alicates	88-95	
	Destornilladores	96-109	
	Martillos	110	
	Varios	111-114	
	Herramienta aislada 1 000V	115-119	
	Herramienta Especial Mecánica	Mecánica	122-153
Motocicletas		154-156	
Chapista		156-160	
Pesados		161	
Accesorios		162	
Herramienta Neumática	Herramienta neumática	164-182	
	Accesorios para redes de aire comprimido	183-185	
Merchandising	Merchandising	188-191	
Otros Equipos	Otros equipos	194-197	



JONNESWAY®

Herramientas Profesionales
• Manuales • Neumáticas •
específicas para automóviles, motocicletas y vehículos pesados





JONNESWAY®

Carros y Composiciones de Herramientas



Carros y composiciones de herramientas



Bolsas vacías y accesorios para carros



Armarios y carros para herramientas

Sus necesidades ...



... nuestra solución!

¡Desarrollamos soluciones únicas para usted!

EVA POWER

Carro de composición de herramientas con **Cajones** con guías telescópicas

TABLEROS

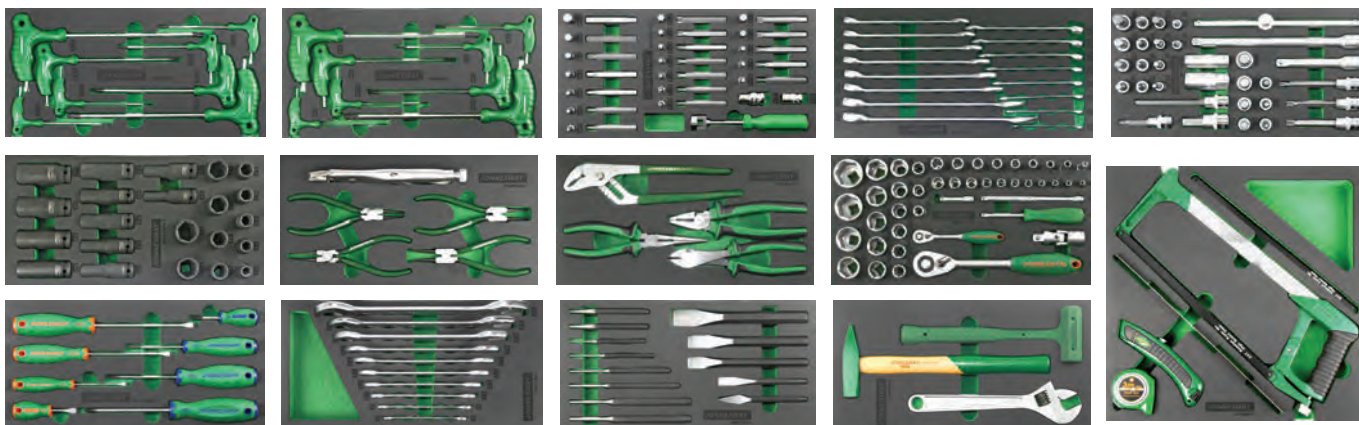

Composición:

- S04H4144KV Juego de llaves de vaso con carraca de 1/2" y 1/4" con 44 piezas
- S04H2132KV Juego de llaves de bujías, prolongadores y puntas con 32 piezas
- W26116KV Juego de llaves mixtas con 16 piezas
- S03A4122KV Juego de llaves de impacto de 1/2" con 22 piezas
- M63113KV Juego de punzones, saca trozos y cinceles con 13 piezas
- D71PP08KV Juego de destornilladores planos/ phillips con 8 piezas
- W25110KV Juego de llaves fijas con 10 piezas

- P011804KV Juego de alicates con 4 piezas
- S29H4141KV Juego de llaves de frenos y puntas con 41 piezas
- H10MB08KV Juego de llaves hexagonales con mango con 8 piezas
- H10MT08KV Juego de llaves torx con mango con 8 piezas
- M09103KV Juego de martillos con 3 piezas
- P32M105KV Juego de alicates de frenos con 5 piezas
- MHS08KV Juego de sierra, regla, cutter y cinta métrica

CARROS



C-6DWB1



C-7DC2B



EVA POWER-V	Color: verde 	1 970.00€
EVA POWER-C	Color: gris 	1 970.00€

EVA POWER BLACK	Color: negro 	1 735.00€
------------------------	--	-----------

MEC SOLUTION

Carro de herramientas con composición flexible, adaptado a sus necesidades

Añadir **3 TABLEROS EVA**, siendo **1 del TIPO A** y **2 del TIPO B**

TABLEROS TIPO



S04H42165SV



S04H31945SV



S04H21845SV



S04H42955SV



S04H461215SV

TABLEROS TIPO

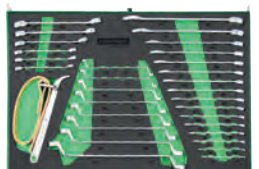

W26234315V



D7371285V



H101215V



D7371345V



P827365V



P827145V



W235595V

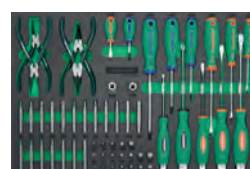

D711575V



W261345V



CARROS



C-6DWB1



C-7DC2B



MEC SOLUTION-V	Color: verde		1 550.00€
MEC SOLUTION-C	Color: gris		1 550.00€

MEC SOLUTION BLACK	Color: negro		1 450.00€
---------------------------	--------------	--	-----------

POWER LINE

Carro de herramientas para mecánico

TABLEROS



Composición:

- Juego 4 alicates clips
- Juego 3 alicates (universal/ puntas/ corte)
- Juego 2 martillos y cincele
- Juego 8 destornilladores planos/ phillips
- Juego 9 llaves macho hexagonal

- Juego 8 llaves torx dobles con mango
- Juego sierra, botadores y llave inglesa
- Juego alicate de presión y alicate ajustable
- Juego llaves de vaso y carraca 1/4"
- Juego llaves vaso y carraca 1/2"

- Juego de puntas 1/2" y 3/8"
- Juego de puntas 1/2" y 3/8"
- Juego 10 llaves fijas
- Juego 16 llaves mixtas
- Juego 8 llaves estrella acodada 75°

CARROS



C-6DWB1



C-7DC2B

MEC POWER 19V Color: verde ■ 1 690.00€
MEC POWER 19C Color: gris ■ 1 690.00€

BLACK POWER 19 Color: negro ■ 1 470.00€



MEC PROF-20

Carro de herramientas para mecánico

TABLEROS

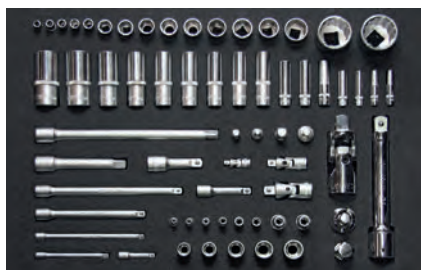

Composición: 271 piezas

Tablero con

Juego de llaves de vasos largos 1/4" y 1/2" de 6 a 27mm
 Juego de llaves de vasos 1/4", 1/2" y 3/4" de 6 a 36mm
 Juego de prolongadores de 1/4", 1/2" y 3/4"
 Adaptadores
 Cardán
 Juego de llaves de vasos torx de 1/4" y 1/2" de E5 a E 24

Tablero con

Juego de llaves de estrella de 10 a 22mm
 Juego de alicates de puntas pequeños
 Juego de llaves de hexagonales cortas
 Galgas
 Martillo de bola
 Llave inglesa

Tablero con

Juego llaves mixtas de 6 a 34mm

Tablero con

Juego de destornilladores planos y phillips, llave torx con mango
 Llave hexagonal con mango

Tablero con

Juego de alicates largos
 Alicata universal
 Alicata de puntas
 Alicata de corte
 Pinza de presión
 Alicata ajustable
 Llave de filtros

Tablero con

Juego de carracas 1/4", 3/4", 1/2", 3/8"
 Carraca extensible de 1/2"
 Juego de puntas cortas y largas de cuadrado 1/2"
 Juego de llaves de vasos torx de 1/2"
 Juego llaves ribe de 1/2"
 Juego llaves XZN de 1/2"
 Juego de llaves hexagonales 1/2"

CARROS



C-6DWB1



C-7DC2B



MEC PROF20-V	Color: verde	2 150.00€
MEC PROF20-C	Color: gris	2 150.00€

MEC PROF20-BLACK	Color: negro	1 985.00€
-------------------------	--------------	-----------

ELECTR. 1000volts

Carro de electricista con composición de herramienta aislada a 1 000v

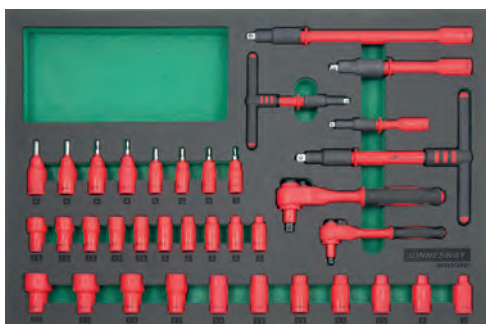
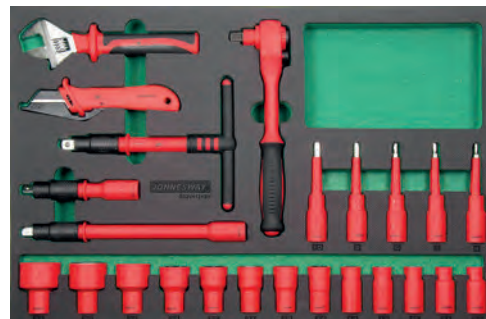
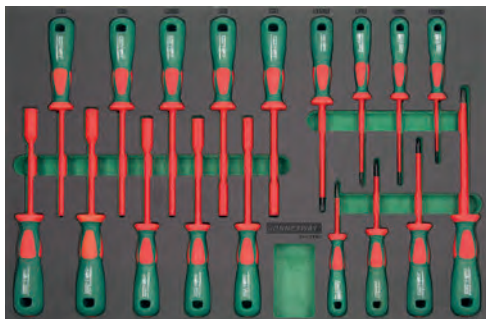
TABLEROS

Composición:

Tablero con 18 llaves aisladas

- 4 Destornilladores planos
- 4 Destornilladores phillips
- 10 Llaves de vaso con mango

Tablero con 36 piezas 1/4" y 3/8"

- 2 Carracas 1/4" y 3/8"
- 2 Mango en T de 1/4" y 3/8"
- 1 Prolongador 100mm de 1/4"
- 10 Llaves de vaso 1/4"
- 4 Puntas 1/4"
- 2 Prolongadores 3/8"
- 11 Llaves de vaso 3/8"
- 4 Puntas 3/8"

Tablero con 24 piezas 1/2"

- 1 Carraca
- 1 Extensión flexible
- 2 Prolongadores
- 13 Llaves de vaso
- 5 Puntas
- 1 Llave inglesa
- 1 Cutter

Tablero con 25 piezas

- 9 Llaves fijas
- 13 Llaves estrella acodada
- 1 Alicata universal
- 1 Alicata de corte
- 1 Alicata de puntas

CARROS

C-6DWB1



C-7DC2B

ELECTR. 1000-V

Color: verde



2 420.00€

ELECTR. 1000-C

Color: gris



2 420.00€

ELECTR. 1000 BLACK

Color: negro



2 255.00€



HV 1000V

Carro de herramientas para electricista

TABLEROS



Composición: 43 piezas

Tablero con

- Juego de alicata de puntas, universal y de corte
- Juego de destornilladores planos y phillips
- Juego llaves de vaso con mango
- Busca polos



Tablero con

- Multímetro digital
- Juego de prolongadores
- Carraca
- Navaja
- Juego llaves de vaso 1/2" de 8 a 22mm
- Juego llaves de estrella de 8 a 14mm
- Juego llaves fijas de 8 a 14mm
- Juego llaves hexagonales de 4 a 8mm
- Llave ajustable

CARROS



C-6DWB1



C-7DC2B



HV1000V-V	Color: verde 	1 670.00€
HV1000V-C	Color: gris 	1 670.00€

HV1000V-BLACK	Color: negro 	1 505.00€
----------------------	--	-----------



ELECTR

Carro de herramientas para electricista, composición general

TABLEROS

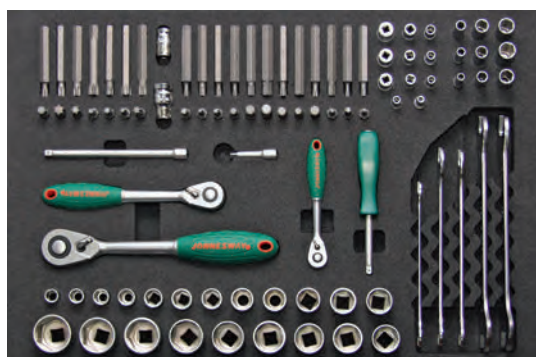
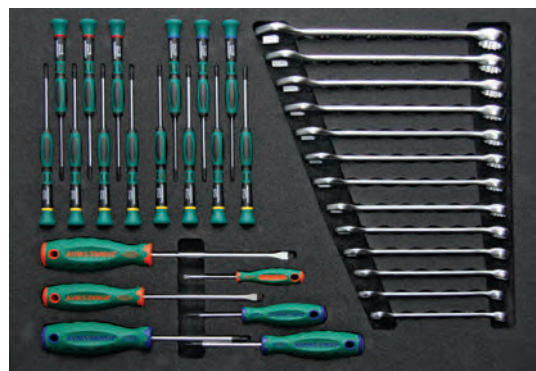

Composición: 144 piezas

Tablero con

Juego alicates universal, de puntas, de corte
Mini alicates
Alicate de pelar
Mordaza para engatilar terminales

Tablero con

Juego de llaves mixtas de 10 a 22mm
Juego de precisión
Destornilladores planos y phillips

Tablero con

Juego de puntas con adaptadores
Juego de llaves fijas perfil fino de 10 a 19mm
Juego llaves de vaso 1/2" de 17 a 30mm
Juego de llaves de vaso 3/8" de 11 a 16mm
Juego de carracas y prolongadores

Tablero con

Bandeja magnética
Lámpara LED
Multímetro digital
Cúter
Tijera
Raspador con láminas



C-6DWB5



C-7DC2B



ELECTR-V

Color: verde



1 750.00€

ELECTR-C

Color: gris



1 750.00€

ELECTR-BLACK

Color: negro



1 550.00€



CHAPEIRO 20

Carro de herramientas para chapista

TABLEROS



Composición: 55 piezas

Tablero con

- Lima de chapista
- Juego de martillos chapista
- Extractores de grapas

Tablero con

- Juego alicates universal, de puntas de corte
- Destornillador de golpe
- Juego de alicates de presión

Tablero con

- Juego de ventosas
- Juego destornilladores planos y phillips de impacto
- Juego de herramientas de desmontaje de guarnecidos plásticos

Tablero con

- Juego de tases para hierro
- Kit desmontaje de cristales parabrisas



C-4DWA1



C-7DC2B



CHAPEIRO20-V	Color: verde	1 600.00€
CHAPEIRO20-C	Color: gris	1 600.00€

CHAPEIRO20- BLACK	Color: negro	1 550.00€
--------------------------	--------------	-----------



CHAPEIRO ALU

Carro de herramientas para chapista

TABLEROS



Composición: 56 piezas

Tablero con

- Lima de chapista
- Juego de martillos chapista
- Extractores de grapas

Tablero con

- Juego alicates universal, de puntas de corte
- Destornillador de golpe
- Juego de alicates de presión

Tablero con

- Juego de ventosas
- Juego de destornilladores planos y phillips de impacto
- Juego de herramientas de desmontaje de guarnecidos plásticos

Tablero con

- Juego de tases para aluminio
- Kit desmontaje de cristales parabrisas



C-4DWA1



C-7DC2B



CHAPEIROALU-V	Color: verde 	1 635.00€
CHAPEIROALU-C	Color: gris 	1 635.00€

CHAPEIROALU-BLACK	Color: negro 	1 585.00€
--------------------------	--	-----------



PINTOR20

TABLEROS



Composición: 55 piezas

Tablero con

Juego de espátulas de desmontaje de guarnecidos
Espejo auxiliar de reparación de abolladuras
Juego de herramientas para extracción de grapas y fijadores

Tablero con

Pistola de pintura
Base para lija
Juego de 4 espátulas
Lijadora orbital
Extractor de terminales de baterías

Tablero con

Juego de llaves de estrella de 6 a 32mm
Cúter
Juego destornilladores planos y phillips

Tablero con

Juego de 6 ventosas y accesorios



C-4DWA1



C-7DB2B

PINTOR20-V

Color: verde



1 580.00€

PINTOR20-C

Color: gris



1 580.00€

PINTOR20-BLACK

Color: negro



1 525.00€

MEC PESADOS

Carro de herramientas con 7 cajones + mango + bloque complementario

TABLEROS

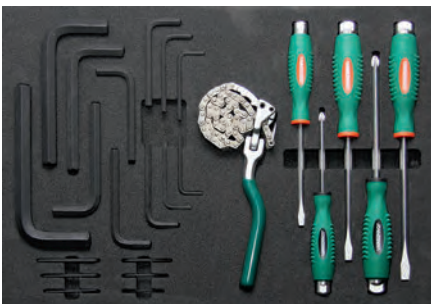

Composición: 162 piezas
Tablero con
 Juego de llaves de vaso de 1/2" de 8 a 34mm con carraca y prolongador
 Juego de llaves torx 1/2" de T30 a T80
 Juego de llaves hexagonales de 1/2" de H5 a H19
 Cardán
 Maneral

Tablero con
 Juego de llaves de vaso de vaso de impacto largas de 1/2" e 3/4" de 10 a 46mm
 Adaptadores
 Prolongador
 Cardán

Tablero con
 Juego de martillos, mazo y alicates

MEC PESADOS 20A

3 350.00€



MEC PESADOS 20B

3 180.00€



Tablero con
 Juego de destornilladores planos y phillips de impacto
 Juego de llaves hexagonales de impacto, llave de filtro

Tablero con
 Juego de llaves estrella de 6 a 32mm
 Juego de llaves fijas de 6 a 32mm

Tablero con
 Juego de llaves de 3/4" de 19 a 50mm con prolongadores, adaptadores, cardán y carraca

Tablero con
 Juego de llaves mixtas de 20 a 46mm

C-SA2

4 650.00€

Armario modular

Dimensiones totales: 2 322x1 980x526mm
 1 Módulo de armario vertical: 600x526x1980mm
 1 Módulo 7 cajones: 861x500x994mm
 1 Módulo 2 puertas: 861x500x994mm
 2 Armarios superiores: 861x300x338mm
 2 Paneles perforados: 861x20x338mm
 1 Tapa madera: 1 725x480x40mm

C-SA2S

4 500.00€

Armario Modular

Dimensiones totales: 2 322x526x1 980mm
 1 Módulo de armario vertical: 600x526x1 980mm
 1 Módulo 7 cajones: 861x500x994mm
 1 Módulo 2 puertas: 861x500x994mm
 2 Armarios superiores: 861x300x338mm
 2 Paneles perforados: 861x20x338mm
 1 Tapa inox: 1 725x480x40mm

C-SA3

6 050.00€

Armario modular

Dimensiones totales: 2 998x526x1 980mm
 1 Módulo de armario vertical: 600x526x1 980mm
 1 Módulo 7 cajones: 861x500x994mm
 1 Módulo 7 cajones: 676x500x994mm
 1 Módulo 2 puertas: 861x500x994mm
 2 Armario superior: 861x300x338mm
 1 Armario superior: 676x300x338mm
 2 Paneles perforados: 861x20x338mm
 1 Panel perforado: 676x20x338mm
 1 Tapa madera: 2 404x480x40mm

C-SA3S

5 900.00€

Armario modular

Dimensiones totales: 2 998x526x1 980mm
 1 Módulo de armario vertical: 600x526x1 980mm
 1 Módulo 7 cajones: 861x500x994mm
 1 Módulo 7 cajones: 676x500x994mm
 1 Módulo 2 puertas: 861x500x994mm
 2 Armario superior: 861x300x338mm
 1 Armario superior: 676x300x338mm
 2 Paneles perforados: 861x20x338mm
 1 Panel perforado: 676x20x338mm
 1 Tapa inox: 2 404x480x40mm



C-SA4S

5 700.00€

Armario modular

Dimensiones totales: 2 998x526x1 980mm
 1 Módulo de armario vertical: 600x526x1 980mm
 1 Módulo 7 cajones: 676x500x994mm
 1 Carro 7 cajones: 671x459x940mm
 1 Módulo 2 puertas: 861x500x994mm
 2 Armario superior: 861x300x338mm
 1 Armario superior: 676x300x338mm
 2 Paneles perforados: 861x20x338mm
 1 Panel perforado: 676x20x338mm
 1 Tapa inox: 2 404x480x40mm



C-SQ2401

1 070.00€

Armario vertical para almacenaje

Dimensiones totales: 600x526x1 980mm
 1 Puerta



C-SP3401

295.00€

Armario superior

Dimensiones totales: 861x300x338mm
 Puerta basculante



C-SQ3401

1 010.00€

Armario ancho con 7 cajones

Top no incluido.

Dimensiones totales: 861x500x994mm
 7 Cajones



C-SQ3402

690.00€

Armario ancho con 2 puertas

Top no incluido.

Dimensiones totales: 861x500x994mm
 2 Puertas



C-SQ3403

925.00€

Armario multifunción

Top no incluido.

Dimensiones totales: 861x500x994mm
 1 Alojamiento para rollo de papel
 1 Compartimento para basura
 1 Compartimento para almacenaje



C-S7DW1

790.00€

Carro vacío para armario de taller

Permite ser guardado en armario de taller

Dimensiones totales: 671x459x940mm
 Peso: 52,4kg
 7 Cajones



Armarios y carros para herramienta
C-SR3401
90.00€

Conjunto de 2 paneles perforados
Dimensiones totales: 861x20x338mm

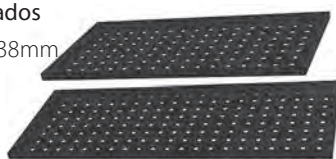
C-SU01
10,20€

Rodapié
Para armario alto.
Longitud: 500mm

C-SU02
10.20€

Rodapié
Es necesario incluir para los módulos de cierre.
Longitud: 470mm

C-SW01
85.00€

Soporte lateral
Es necesario incluir una unidad de soporte superior de armario, cuando esté en el extremo.

C-SW02
56.00€

Soporte central para unión de módulos
Es necesario incluir una unidad por cada 2 módulos.

C-SM
290.00€

Tablero en madera para armario
Precio por metro
Dimensiones totales: 1 000x480x40mm

C-SG
245.00€

Tablero en chapa galvanizada
Precio por metro
Dimensiones totales: 1 000x480x40mm

C-SInox
625.00€

Tablero en acero inoxidable
Precio por metro
Dimensiones totales: 1 000x480x40mm

C-1DM1
355.00€

Cajón lateral de apoyo de laptop/ tablet hasta 14"
Adicional para carros de herramientas
Dimensiones cajones: 410x285x70



* Ejemplo de aplicación en carro de herramientas

C-3DW5
765.00€

Carro vacío para herramienta
Dimensiones totales: 670x460x960mm
Peso: 54,2kg
3 Cajones de 576x380x75mm
1 Almacenaje con 2 puertas de 603x404x478mm



C-4DWA1 Color: verde  700.00€

C-4DWA1G Color: gris  700.00€

Carro vacío para herramientas con 4 cajones

Superficie de trabajo especial

Dimensiones totales: 670x460x795mm

2 Cajones de 579x380x56mm

1 Cajón de 579x380x123mm

1 Cajón de 579x380x179mm



C-7DC2B Color: negro  610.00€

Carro vacío para herramientas con 7 cajones

Dimensiones totales: 670x460x963mm

5 Cajones de 576x380x75mm

2 Cajones de 576x380x154mm

Peso total: 57kg

Capacidad de carga: 1v40kg/rueda

Dimensión ruedas: 127x25,5mm



C-6DWB1 Color: verde  860.00€

C-6DWB1G Color: gris  860.00€

Carro vacío para herramientas con 6 cajones

Superficie de trabajo especial

Dimensiones totales: 670x460x967mm

4 Cajones de 579x380x56mm

1 Cajón de 579x380x123mm

1 Cajón de 579x380x179mm



C-6DWB5 840.00€

Carro vacío para herramientas con 6 cajones

Superficie recubierta de plástico y soporte de herramienta

Dimensiones totales: 670x460x967mm

4 Cajones de 579x380x56mm

1 Cajón de 579x380x123mm

1 Cajón de 579x380x179mm



C-7DS1 1 130.00€

Carro vacío para herramientas con 7 cajones

Tapa en acero

Dimensiones totales: 710x500x967mm

1 Panel lateral perforado

1 Panel lateral para compartimentos para almacén

4 Ruedas, 2 direccionables con freno

Peso total: 74,5kg

Capacidad de carga: 160kg/rueda

* Las cajas laterales son una opción



C-7DW9 999.00€

Carro vacío para herramientas con 7 cajones

Sistema de seguridad con apertura de 1 sólo cajón

Dimensiones totales: 670x460x967mm

5 Cajones de 576x380x75mm

2 Cajones de 576x380x154mm

Peso total: 74,5kg

Capacidad de carga: 75kg/rueda

Dimensión ruedas: 127x50,8mm



C-7 TOWER

1 350.00€

Carro vacío con 13 cajones

Dimensiones totales: 670x460x1 334mm
 5 Cajones de 576x380x75mm
 2 Cajones de 576x380x154mm
 Caja superior
 3 Cajones de 170x275x50mm
 2 Cajones de 569x275x50mm
 1 Cajón de 569x275x75mm



C-13DW53

2 200.00€

Carro grande vacío para herramientas con 13 cajones

Dimensiones totales: 1 358x460x1 150mm
 10 Cajones de 576x380x75mm
 2 Cajones de 579x380x154mm
 1 Cajón de 1 216x380x173mm



C-A16W

555.00€

Armario con 7 cajones

Incluye 2 ruedas para el caso de acoplamiento con la C-7/ C-6
 5 Cajones de 288x380x75mm
 2 Cajones de 288x380x154mm



C-10DW42

1 800.00€

Carro grande vacío para herramientas con 10 cajones

Dimensiones totales: 1 070x460x981mm
 1 Compartimento de almacenaje de 316x404x1 150mm
 5 Cajones de 288x380x75mm
 2 Cajones de 576x380x154mm
 1 Cajón de 288x380x154mm
 1 Cajón de 576x380x154mm
 1 Cajón de 928x380x173mm



C-A17W

Color: verde



335.00€

C-A17WG

Color: gris



335.00€

Armario con 1 puerta

Incluye 2 ruedas para el caso de acoplamiento con la C-7/ C-6



C-T3

575.00€

Carro vacío para herramientas con 3 cajones

Apertura superior

Dimensiones totales: 780x520x884mm



C-T12

252.00€

Carro con 3 estantes

Dimensiones totales: 716x410x880mm

Peso: 20kg

Ruedas: 4 (2 fijas+2 direccionales)



C-5CD

340.00€

Caja de metal para herramientas con 5 maletas

Dimensiones totales: 431x307x381mm

5 Maletines de 48x245x55mm



C-6DA4

365.00€

Caja de metal vacía para herramientas con 6 cajones

Compartimento en la parte superior con varias particiones

Dimensiones totales: 660x307x374mm

3 Cajones de 172x270x41mm

2 Cajones de 572x270x31mm

1 Cajón de 572x270x65mm



C-6DA494

890.00€

Caja de herramientas con 6 cajones - 98 piezas

Compartimento en la parte superior con varias particiones

Dimensiones totales: 660x307x374mm

Composición:

AG10002SC

D376514SC

R4811SC

P0813SC

S04H5129SC

V11011SC

W25117SC

W27AT02SC



Cajas vacías y accesorios para carros

C-3DH5

177.00€

Caja de metal vacía para herramientas con 3 cajones

Compartimento en la parte superior

Dimensiones totales: 535x220x290mm

3 Cajones de 505x195x45mm



C-3DH2

96.50€

Caja de metal vacía para herramientas con 5 compartimentos

Dimensiones totales: 470x240x220mm



C-3DH262

415.00€

Caja de metal para herramientas con 5 compartimentos - 62 piezas

Dimensiones totales: 470x220x350mm

Composición

P106 Alicates de corte

P116 Alicates de puntas

P087 Alicates universales

D70 Juego de 6 destornilladores planos/ phillips

W26 Juego de 18 llaves mixtas

R2904 Carraca de 1/2"

S04H41 Juego de 18 llaves de vaso

S15H472 Adaptador

S24H4 Prolongadores

S22H41450 Extensión flexible 450mm

S23H41300 Extensión flexible 300mm

S21H4150 Prolongador

S17H4121 Llaves de bujías 21mm

H03SM109S Juego de llaves hexagonales



Cajas vacías y accesorios para carros

C-A456 82.00€

Superficie de trabajo moldeado

Aplicables en los carros C-4/ C-6 e C-7



C-A9 62.00€

Base de tornillo de banco y soporte de rodillo de papel



C-A27 58.00€

Encimera en acrílico para carros

Aplicables en los carros C-5DW/ C-6DW e C-7DW



C-7DW1-TS 119.00€

Encimera completa para carros

Aplicable solamente a los carros C-5DW/ C-6DW y C-7DW

Composición

1 Tapa acrílico resistente a los golpes

1 Base metálica de apoyo

1 Revestimiento EVA de 2mm



C-A31 20.50€

Soporte lateral con mango en T para fijación



C-A3 Color: verde 23.00€

Asa de carro de herramientas

Aplicable a C-4DW; C-6DW y C-7DW



C-A3-B Color: negro 23.00€

Asa de carro de herramientas

Aplicable a C-7DB2 y C-7DC2

C-A3G Color: gris 23.00€

Asa de carro de herramientas

Aplicable a C-4DW; C-6DW y C-7DW

C-BS

Juego de carril derecho e izquierdo, para cajones de carros y cajas

Ref.	Aplicación	Precio
C-BS Kit1	Carros: C-4DW/ C-5DW/ C-6DW/ C-7DW	18.50€
C-BS Kit2	Cajas: C-6DA4	14.00€
C-BS Kit3	Carros: C-10DW/ C-13DW	22.00€



C-PC

Cerradura de bloqueo

Ref.	Aplicación	Precio
C-PC1	C-6DA4	7.90€
C-PC2	C-5/ C-6/ C-7/ C-10/ C-13	8.30€
C-PC3	C-4	13.20€



C-PC4 14.00€

Bombin de cerradura para llaves circulares

Incluye dos llaves.



C-WHEEL

Ruedas

Ref.	Tipo	Aplicación carro	Precio
C-WHEEL1	fija	C-6/ C-7	18.00€
C-WHEEL2	freno	C-6/ C-7	24.50€
C-WHEEL5	fija	C-4/ C-5/ C-7DB2	16.70€
C-WHEEL6	freno	C-4/ C-5/ C-7DB2	23.50€
C-WHEEL8	fija	C-T3/ C-/12	14.30€
C-WHEEL9	freno	C-T3/ C-/12	15.90€



C-A

Tornillo de banco

Ref.	Apertura (mm)	Peso (kg)	Precio
C-A7*	76	6	104.00€
C-A8*	101	7,25	127.00€
C-A10	127	10,2	165.00€
C-A11	152	14	195.00€
C-A12	203	18	255.00€
C-A13	254	24	335.00€



* Aplicable en carro de herramienta (necesario soporte C-A9)

Cajas vacías y accesorios para carros



C-B

Torno de banco con doble rotación

Rotación 360° de la base del torno

Rotación 360° del cabeza del torno

Ref.	Apertura (mm)	Peso (kg)	Precio
C-B5	127	17	203.00€

C-A2501S

26.00€

Conjunto de cajas plásticas para cajones de carros de herramienta

Composición

12 Cajas 93x93x43mm

4 Cajas 283x93x43mm

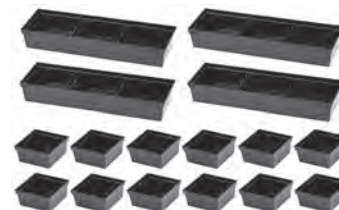

C-APB

27.50€

Conjunto de cajas plásticas para cajones de carros de herramienta

Composición

8 Cajas 283x93x43mm

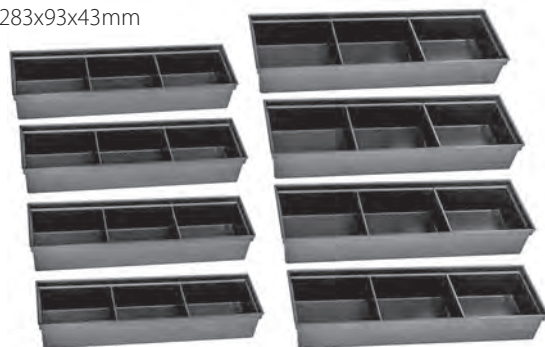



JONNESWAY®

VDE Prüf- und Zertifizierungsinstitut

ZEICHENGENEHMIGUNG MARKS APPROVAL

Jonnesway Enterprise
Co. Ltd.
6F-9, No.51, Sec.2, Keelung Rd.
110 TAIPEI
TAIWAN

ist berechtigt, für ihr Produkt /
is authorized to use for their product

Kabelmesser
Cable knives

die hier abgebildeten markenrechtlich geschützten Zeichen
für die ab Blatt 2 aufgeführten Typen zu benutzen /
the legally protected Marks as shown below for the types referred to on page 2 ff.



Geprüft und zertifiziert nach /
Tested and certified according to

DIN EN 60900 (VDE 0682-201):2013-04; EN 60900:2012

Das Produkt entspricht den Anforderungen des deutschen Produktsicherheitsgesetzes (ProdSG)
hinsichtlich der Gewährleistung von Sicherheit und Gesundheit.
The product covers the requirements of the German Act "Produktsicherheitsgesetz (ProdSG)"
regarding the ensurance of safety and health.



Befristet zum / valid until: 2020-02-29

Aktenzeichen: 5010169-3940-0010 / 223208

File ref.:

VDE Prüf- und Zertifizierungsinstitut GmbH
VDE Testing and Certification Institute
Zertifizierungsstelle / Certification

Ausweis-Nr.: 40035280

Blatt 1

Certificate No.

Page

Weitere Bedingungen siehe Rückseite und Folgeblätter /
Further conditions see reverse and following pages

Offenbach, 2012-06-26

(letzte Änderung / updated 2016-05-25)

A: Fabian
VDE Zertifikate sind nur gültig bei Veröffentlichung unter:
VDE certificates are valid only when published on:

<http://www.vde.com/zertifkat>
<http://www.vde.com/certificate>

VDE



VDE Prüf- und Zertifizierungsinstitut

ZEICHENGENEHMIGUNG MARKS APPROVAL

Jonnesway Enterprise
Co. Ltd.
6F-9, No.51, Sec.2, Keelung Rd.
110 TAIPEI
TAIWAN

ist berechtigt, für ihr Produkt /
is authorized to use for their product
Zusammensetzbares Werkzeug
Assembly tool

die hier abgebildeten markenrechtlich geschützten Zeichen
für die ab Blatt 2 aufgeführten Typen zu benutzen /
the legally protected Marks as shown below for the types referred to on page 2 ff.



Geprüft und zertifiziert nach /
Tested and certified according to

DIN EN 60900 (VDE 0682-201):2013-04; EN 60900:2012

Das Produkt entspricht den Anforderungen des deutschen Produktsicherheitsgesetzes (ProdSG)
hinsichtlich der Gewährleistung von Sicherheit und Gesundheit.
The product covers the requirements of the German Act "Produktsicherheitsgesetz (ProdSG)"
regarding the ensurance of safety and health.



Befristet zum / valid until: 2020-04-30

Aktenzeichen: 5010169-3940-0019 / 223207

File ref.:

VDE Prüf- und Zertifizierungsinstitut GmbH
VDE Testing and Certification Institute
Zertifizierungsstelle / Certification

Ausweis-Nr.: 40035263

Blatt 1

Certificate No.

Page

Weitere Bedingungen siehe Rückseite und Folgeblätter /
Further conditions see reverse and following pages

Offenbach, 2012-06-26

(letzte Änderung / updated 2016-06-20)

M. Tschudi
VDE Zertifikate sind nur gültig bei Veröffentlichung unter:
VDE certificates are valid only when published on:

<http://www.vde.com/zertifkat>
<http://www.vde.com/certificate>

VDE





JONNESWAY®

Herramientas Manuales



Tableros para
herramienta

Destornilladores



Herramienta
manual

Martillos



Alicates

Varios





AG010002SP

52.00€

Juego de 4 alicates de clips

Composición:

- AG010002 Alicates de clips interiores
- AG010005 Alicates de clips interiores de punta acodada
- AG010008 Alicates de clips exteriores
- AG010011 Alicates de clips exteriores de puntas acodadas 90°

A



AG010026SP

60.00€

Juego de martillos y cincel

Composición:

- M09300 Martillo de mecánico 300g
- M11035 Mazo moldeado poliuretano 400g
- M61 Juego de 3 cincelos

A



AG010150SC

114.00€

Juego de 8 alicates de clips

Composición:

- 4 Alicates de puntas rectas
- 4 Alicates de puntas curvas

B



AG10001SP

113.00€

Juego de machos y terrajas

Composición:

- 17 Machos de roscar manuales: M3 a M12
- 17 Terrajas: M3 a M12
- 1 Porta terrajas
- 1 Giramachos
- 1 Mango giramachos

B



AI10001SP

219.00€

Juego de herramientas para reemplazar válvulas de culata

Composición:

- AN010064 Compresor de válvulas de culata
- AI020056 Alicates para sellos de válvulas
- AI020099 Adaptador resortes de válvulas
- AI020100 Apoyo de válvulas
- AI010012A Extractor de asientos de válvulas

B



AI10002SP

165.00€

Juego de herramientas para reemplazar polea del cigüeñal

Composición:

- AE310030 Desmontable de 2 patas
- AE10035-1 Adaptador para 3 patas
- AN010038 Extractor sello
- AI020087A Extractor polea del cigüeñal

B



AI10003SP

138.00€

Juego de llaves de vaso para filtros y cárteres

Composición:

- 9 Llaves de vaso para filtros
- 14 Llaves para tapón del cárter
- 1 Llave universal para filtros

B



Description		
○ 8mm	BMW, Ford	△ 10mm Renault
○ 9mm	General Motor	T-Bar To Drive
○ 10mm	Ford	30-160mm Oil Filter Chain 3/8" Oil
○ 12mm	Fiat, Lancia, Peugeot	Filter Cap Wrench
○ 14mm	Mercedes, Lancia	93mm-15 GM, Nissan, Volvo, Mazda, Audi, VW, etc.
○ 17mm	BMW, Austin, Audi, VW	76mm-14 VW, Porsche, Mercedes, BMW, Toyota
○ 3/8"	General Motor	75.6mm-14 Mazda, General Motor
□ 10mm	BMW, Renault, Toyota	38mm etc Diesel Engine
□ 8mm	Citroen, Peugeot, Renault, Talbot, Volvo	36mm Benz, VW, BMW/M52, M60, M73
□ 11mm	Ford	32mm GM, Saab, Saturn
□ 13mm	Nissan, Subaru	30mm General Motor
□ 3/8"	Honda, Mazda, Renault, Saab, Volvo	27mm Mercedes
□ 7mm	General Motor	24mm BMW/ 5 & 7 series

AN10002SP

214.00€

Juego de 42 piezas de herramienta para frenos

Este tablero ocupa la mitad de cajones del carro de herramientas.

C



D70105SP

42.00€

Juego de 5 llaves destornilladores planos/ phillips

Composición/ medidas en mm:

- | | | | |
|-------------|-----------------------|-------------|-------------------------|
| D70S | 3 Destornill. planos: | D70P | 2 Destornill. phillips: |
| | 6,5x125 | | PH 2x100 |
| | 8x150 | | PH 3x150 |
| | 9,5x175 | | |

A



D71PP08SP

38.50€

Juego de 8 llaves destornilladores planos/ phillips

Composición/ medidas en mm:

- | | | | |
|-------------|-----------------------|-------------|-------------------------|
| D71S | 4 Destornill. planos: | D71P | 4 Destornill. phillips: |
| | 6,5x38 | | 2x38 |
| | 4x80 | | 1x80 |
| | 5,5x125 | | 2x100 |
| | 6,5x150 | | 3x150 |

A



D725N08SP

79.00€

Juego de 8 llaves de vaso hexagonal con mango

Composición:

Llaves de 6 a 13mm

C



H10MB08SP

46.00€

Juego de 8 llaves macho allen con puntas esférica con mango

Composición/ medidas en mm:

- | | | |
|--------------|---------|--------|
| H10MB | 2x100 | 5x150 |
| | 2,5x100 | 6X150 |
| | 3x100 | 8X200 |
| | 4x100 | 10X200 |

B



H10MT08SP

46.00€

Juego de 8 llaves torx dobles tamperproof con mango

Composición/ medidas en mm:

- | | | |
|--------------|---------|---------|
| H10MT | T10x100 | T27x150 |
| | T15x100 | T30X150 |
| | T20x100 | T45X200 |
| | T25x100 | T50X200 |

B



H20MT08SP

49.00€

Juego de 8 llaves torx dobles con mango

Composición/ medidas en mm:

- | | |
|---------|---------|
| T10x110 | T27x145 |
| T15x120 | T30X155 |
| T20x125 | T45X185 |
| T25x135 | T50X205 |

B



M09513SP 86.00€

Juego de 2 martillos y botadores

Composición:

- M07016 Martillo con punta de goma
- M09500 Martillo de mecánico
- M63M106S Juego botadores cromados
- M64M105S Juego botadores y cortafrios cromados

A



M645114SP 86.50€

Juego de sierra, llave inglesa, botadores y cortafrios

Composición:

- M63 6 Botadores
- M64 4 Cortafrios
- W27AS10 Llave inglesa
- MHS100AG Sierra

B



MTC101SP 220.00€

Juego de herramienta de medición

Composición/ medidas en mm:

- Calibre 150
- Pieza de metal 300
- Regla de metal 300
- Compás 200
- Micrómetro 0-25
- Micrómetro 25-50
- Lápiz

B



P018SP1 67.00€

Juego de 3 alicates y 7 llaves de allen

Composición:

- P018 Alicates universal
- P038 Alicates de corte diagonal
- P068 Alicates de puntas
- H01SM109S Llaves de 6 caras

A



P018SP 56.00€

Juego de 3 alicates

Composición:

- P018 Alicates universal
- P038 Alicates de corte diagonal
- P068 Alicates de puntas

A



P04704SP 65.00€

Juego de 4 alicates de corte

No usar en metal

A



P0803SP 53.00€

Juego de 3 alicates

Composición:

- P087 Alicates universal
- P097 Alicates de corte diagonal
- P118 Alicates de puntas

A



P0903SP 62.00€

Juego de 3 alicates

Composición:

- P0118 Alicates universal
- P0918 Alicates de corte diagonal
- P1118 Alicates de puntas

A



P2710SP 37.00€

Juego de 2 alicates de agarre

Composición:

- P2710 Alicates ajustable
- P32M10A Alicates de presión

A



P2803SP

58.00€

Juego de 2 alicates y llave inglesa

Composición:

- W27AS10 Llave inglesa
- P2810 Alicates ajustable
- P32M10A Alicates de presión

A



S03A4122SP

93.00€

Juego de 22 llaves de impacto 1/2"

Composición/ medidas en mm:

- S03A4 Llaves: 10; 11; 12; 13; 14; 16; 17; 19; 21; 22 y 24
- S03AD4 Llaves: 10; 11; 12; 13; 14; 16; 17; 19; 21; 22 y 24

A



S04H2125SP

56.00€

Juego de llaves de vaso con 24 piezas de 1/4"

Composición/ medidas en mm:

- R3702 Carraca de 48 dientes
- S04H2 Llaves de vaso: 4; 5; 5,5; 6; 7; 8; 9; 10; 11; 12 y 13
- S04HD2 Llaves de vaso: 5; 6; 7; 8; 9; 10; 11; 12 y 13
- S24H250 Prolongador 50
- S24H2150 Prolongador 150
- S26H2150 Mango

A



S04H3157SP

127.00€

Juego de 8 llaves de vaso con 56 piezas de 1/4" y 3/8"

Composición/ medidas en mm:

- R3702 Carraca 1/4" de 48 dientes
- S04H2 Llaves 1/4": 4; 4,5; 5; 5,5; 6; 7; 8; 9; 10; 11; 12 y 13
- S04HD2 Llaves 1/4": 8; 10; 12 y 13
- S09H2 Puntas allen: 3; 4; 5 y 6
- S07H2 Puntas torx: T10; T15; T20; T25; T27 y T30
- S10H2 Puntas planas: 4; 5,5 y 7
- S11H2 Puntas phillips: PH1; PH2 y PH3
- S24H2 Prolongadores
- S16H302 Adaptador extensible
- S16H302 Adaptador universal
- S16H302 Mango
- R3703 Carraca 3/8" de 48 dientes
- S04H3 Llaves 3/8": 14; 15; 17; 18; 19; 20; 22 y 24
- S04HD3 Llaves 3/8": 14; 15 y 17
- S17H3 Llaves de bujías: 16 y 21
- S24H3 Prolongadores
- S15H356 Adaptador extensible 3/8" - 1/2"
- S15H356 Adaptador universal

B



S04H3536SP

108.00€

Juego de llaves de vaso 7 llaves mixtas con 36 piezas de 3/8"

Composición/ medidas en mm:

- R3503 Carraca de 72 dientes
- S04H3 Llaves de vaso: 6 a 22
- S24H3 Prolongadores
- S24H3 Adaptador de extensión flexible 1/2" - 3/8"
- S17H3 Llaves de bujías: 16 y 21
- S15H356 Adaptador universal
- W26 Llaves de mixtas fija/ estrella: 7 a 17

B



S04H4125SP

97.00€

Juego de llaves de vaso con 25 piezas de 1/2"

Composición/ medidas en mm:

- R3704 Carraca de 48 dientes
- S04H4 Llaves: 10; 11; 12; 13; 14; 15; 16; 17; 18; 19; 20; 21; 22; 23; 24; 27; 30 y 32
- S24H4 Prolongadores
- S17H4 Llaves de bujías: 16 y 21
- S23H4125 Extensión flexible
- S15H472 Adaptador universal

B



S04H4131SP

130.00€

Juego de llaves y carraca con 31 piezas de 1/2"

Composición/ medidas en mm:

- Carraca de 72 dientes
- Llaves de vaso: 10 a 32
- Llaves de bujías: 16 y 21
- Cardán
- Prolongador de 125
- Prolongador de 250
- Extensión flexible de 250
- Puntas allen de 5; 6; 8; 10 y 12

C



S04H4524SP

110.00€

Juego de llaves de vaso 6 caras con 24 piezas de 1/2"

Composición/ medidas en mm:

- R3704 Carraca de 48 dientes
- S04H4 Llaves: 10; 11; 12; 13; 14; 15; 16; 17; 18; 19; 20; 21; 22; 23; 24; 27; 30 y 32
- S24H4 Prolongadores 5" y 10"
- S15H472 Adaptador universal
- S22H41375 Mango flexible 15"
- S23H41300 Extensión flexible

B



S04H4726SP

115.00€

Juego de llaves de vaso con 26 piezas de 1/2"

Composición/ medidas en mm:

- R3704 Carraca de 48 dientes
- S04H4 Llaves de vaso: 12; 13; 14; 15; 16; 17; 18; 19; 20; 21; 22; 23; 24; 25; 26; 27; 28; 30 y 34
- S24H4 Prolongadores 5" y 10"
- S17H4116 Llaves de bujías 16
- S15H472 Adaptador universal
- S23H41300 Extensión flexible
- S41H4 Manivela de mango de metal

B



S04H4728SP

107.00€

Juego de llaves de vaso 6 caras con 28 piezas de 1/2"

Composición/ medidas en mm:

- R3704 Carraca de 48 dientes
- S04H4 Llaves de vaso: 8; 9; 10; 11; 12; 13; 14; 15; 16; 17; 18; 19; 20; 21; 22; 23; 24; 25; 26; 27; 28; 30; 32 y 34
- S24H4250 Extensor 10"
- S15H472 Adaptador universal
- S23H41300 Extensión flexible

B



S06H427SP

92.00€

Juego de llaves de vaso allen con 27 piezas de 1/2" y 3/8"

Composición:

- S09H4 Puntas 6 caras de 1/2"
- S49H4 Puntas estriados de 1/2"
- S09H3 Puntas 6 caras de 3/8"

A



S09H4118SP

70.00€

Juego de llaves de vaso allen 6 caras con 18 piezas de 1/2"

Composición:

- Llaves 55mm: H5; H6; H7; H8; H10; H12; H14; H17 y H19
- Llaves 100mm: H5; H6; H7; H8; H10; H12; H14; H17 y H19

A



S29H4140SP

50.00€

Juego 40 puntas de 3/8" para cuadradillo de 1/2" y 3/8"

Composición:

- Puntas 6 caras
- Puntas torx
- Puntas estriados
- Porta puntas

A



V1311SP 147.00€

Juego de alicates de engatillar y pelar cables

Composición:

- V1311 Alicates de engatillar terminales aislados y no aislados
- V1401 Alicates para pelar
- AG010031A Imán con espejo
- Test para circuitos
- Kit con 60 terminales

B



W23108SP 63.00€

Juego de 8 llaves de estrella acodadas 75°

Composición/ medidas en mm:

- W23 Llaves: 6x7; 8x9; 10x11; 12x13; 14x15; 16x17; 18x19 y 20x22

A



W24A109SP 153.00€

Juego de 9 llaves de estrella acodadas abierta y flexible

Composición/ medidas en mm:

- W24A Llaves: 8x8; 10x10; 11x11; 12x12; 13x13; 14x14; 17x17; 19x19 y 22x22

A



W25110SP 60.00€

Juego de 10 llaves fijas

Composición/ medidas en mm:

- W25 Llaves: 6x7; 8x9; 10x11; 12x13; 14x15; 16x17; 18x19; 21x23; 24x27 y 30x32

A



W26112SP 58.00€

Juego de 12 llaves mixtas fija/ estrella

Composición/ medidas en mm:

- W26 Llaves: 8; 9; 10; 11; 12; 13; 14; 15; 16; 17; 19 y 22

A



W26116SP 73.00€

Juego de 16 llaves mixtas fija/estrella

Composición/ medidas en mm:

- W26 Llaves: 6; 7; 8; 9; 10; 11; 12; 13; 14; 15; 16; 17; 18; 19; 22 y 24

B



W45112SP 148.00€

Juego de 12 llaves mixtas fija/ carraca de 72 dientes

Composición/ medidas en mm:

- W45 Llaves: 8 a 19

A



W47108SP 80.00€

Tablero de 8 llaves de estrella acodada angular con carraca

Composición/ medidas en mm:

- W47 Llaves: 6x7; 8x9; 10x11; 12x13; 14x15; 16x18; 17x19 y 21x22

A



W60115SP 170.00€

Juego de 15 llaves fijas/ carraca reversible de 72 dientes

Composición/ medidas en mm:

- W60 Llaves: 9 a 19
- Adaptadores de 1/4"; 3/8" y 1/2"
- Porta puntas de 10

B



W70A118S 265.00€

Juego de llaves en T con carraca articulados

Composición/ medidas en mm:

- W60 Llave en "T" de 300
- Llave en "T" de 50
- Llave con carraca de 72 dientes
- Prolongador de 3"
- Prolongador de 6"
- Adaptador 3/8" (F)x3/8" (F)

B



Tableros para herramienta en carros

Tableros en espuma de alta densidad EVA

JA-C131SV

645.00€

Cajón completo para servicio de neumáticos (cajón completo)

Composición:

- JAI-0924 Pistola neumática de 1/2"
- JAR-6309A Carraca neumático de 1/2"
- JAG-0906R Esmeriladora neumática de 1/4"
- Llaves de impacto largo de 1/2"
- Llaves de impacto de 1/2"
- Adaptador de 3/8"-1/2"
- Adaptador de 1/2"- 3/8"
- Adaptador de 1/2"-3/4"
- Cardán de 1/2"
- Prolongadores de 1/2"

D



D71157SV

208.00€

Cajón con destornilladores planos/ phillips, alicates y puntas (cajón completo)

Composición/ medidas en mm:

- Destornill. planos: 6,5x38; 4x80; 5,5x125 y 6,5x150
- Destornill. phillips: PH2x38; PH1x80; PH2x100 y PH3x150
- Destornill. planos/ de golpe: 6,5x125; 8x150 y 9,5x175
- Destornill. phillips/ de golpe: PH2x100 y PH3x150
- Puntas hexagonales: 4; 5; 6; 7; 8; 10 y 12 de 30 y 75mm de longitud
- Puntas torx: T20; T25; T30; T40; T45; T50 y T55 de 30 y 75mm de longitud
- Puntas XZN: M5; M6; M8; M10 y M12 de 30 y 75mm de longitud
- Porta puntas de 3/8" y 1/2"
- Alicates de frenos

D

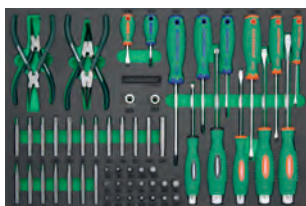

D737128SV

202.00€

Cajón con destornilladores planos/ phillips (cajón completo)

Composición:

- D71PP08SP Juego de destornilladores planos/ phillips
- D70105SP Juego de destornilladores planos/ phillips pancada
- M645114SP Juego de sierra, llave inglesa, botadores y cortafrios

D



D737134SV

198.00€

Cajón con destornilladores planos/ phillips (cajón completo)

Composición:

- D3750P065S Juego de llaves de precisión
- D3750T08S Juego de llaves de precisión
- D70105SP Juego de destornilladores plano/ phillips pancada
- D71PP08SP Juego de destornilladores plano/ phillips
- W43A1067 Juego de llaves de vaso flexible
- W43A0607 Llave flexible 06x07

D



H10121SV

165.00€

Cajón con llaves macho allen con mango, cincel y martillos (cajón completo)

Composición:

- H10MB08S Juego de llaves dobles allen con mango
- H10MT08S Juego de llaves dobles torx tamperproof con mango
- AG010026S Juego de martillos y cincel

D



P82714SV

260.00€

Cajón con alicates (cajón completo)

Composición:

- P018SP Juego de alicates
- P2710SP Juego de alicates
- AG010002SP Juego de alicates de clips
- P71 Juego de mini alicates

D



P82736SV

280.00€

Cajón con alicates y vasos de puntas (cajón completo)

Composición:

- S06H427SP Juego de llaves de vaso de puntas de 1/2" y 3/8"
- AG010002SP Juego de alicates de clips
- P018SP Juego de alicates
- P2710SP Juego de alicates

D



S04H2184SV

199.00€

Cajón con 74 piezas de 1/4" (cajón completo)

Composición:

- Carraca de 1/4"
- Llaves de vaso de 1/4": 4 a 14mm
- Puntas hexagonales de 1/4": H2 a H6
- Adaptador 3/8"(F) x 1/4" (M)
- Adaptador 1/4" (M) x 3/8" (F) para cable en "T" corredizo
- Cardán de 1/4"
- Prolongadores de 1/4": 100mm y 150mm
- Manivela 1/4": 150mm
- Extensión flexible de 1/4": 130mm
- Mango de 1/4" con función fija/ cardán 280mm
- Extensor flexible de 1/4": 145mm
- Puntas phillips, plana, pozidrive, hexagonales, torx
- Llaves de precisión plano/ phillips
- Destornillador plano/ impacto 9,5x200mm y 9,5x300mm
- Destornillador plano 5x150mm
- Destornillador plano aislado 1000V 5,5x125mm

D

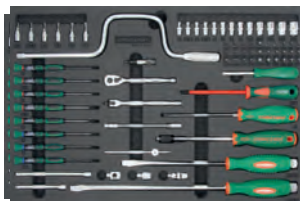

S04H3194SV

242.00€

Cajón con 94 piezas de 1/4" y 3/8" (cajón completo)

Composición:

- Carraca de 1/4"
- Llaves de vaso de 1/4": 5 a 14mm
- Puntas planas de 1/4": 3,5; 5,5 y 7mm
- Puntas hexagonales de 1/4": H3, H4, H5, H6 y H7
- Puntas phillips de 1/4": PH1; PH2 y PH3
- Puntas torx interior de 1/4": E4; E5; E6; E7 y E8
- Puntas torx de 1/4": T10; T15; T20; T25; T30; T35 y T40
- Mango de 1/4" con función fija/ cardán 280mm
- Puntas torx tamperproof con encaixe de 1/4": T7 a T40
- Puntas phillips con encaje de 1/4": PH1; PH2 y PH3
- Extensión flexible de 1/4": 115mm
- Prolongador de 1/4": 150mm
- Cardán de 1/4"
- Juego de puntas de 1/4"
- Punta torx tamperproof de 3/8": T55
- Carraca de 1/4" de 36 dientes
- Adaptador 3/8" x 1/4"
- Llaves de vaso 3/8": 7 a 22mm
- Llaves torx interior 3/8": E10; E12 y E14
- Llave torx 3/8": T40
- Puntas XZN 3/8": M6; M8 y M10
- Prolongadores 3/8": 75mm y 150mm
- Carraca y carraca flexible de 3/8" con 36 dientes
- Cardán de 3/8"
- Adaptador 1/4" (F) x 3/8" (M)

D



Tableros para herramienta en carros

Tableros en espuma de alta densidad EVA

S04H42165SV

260.00€

Cajón con 65 piezas de 1/4" y 1/2" (cajón completo)

Composición:

- Carraca de 1/4" de 48 dientes
- Llaves de vaso 1/4": 4 a 13mm
- Llaves de vaso largas de 1/4": 5 a 13mm
- Prolongadores de 1/4": 50mm y 150mm
- Mango de 1/4"
- Carraca de 1/2" de 48 dientes
- Llaves de vaso 1/2": 10 a 32mm
- Llaves de bujías 1/2": 16 y 21mm
- Prolongadores de 1/2": 125mm y 250mm
- Extensión flexible
- Cardán de 1/2"
- Llaves mixtas de 6 a 24mm

D



S04H4295SV

265.00€

Cajón con llaves de vaso y carraca (cajón completo)

Composición:

- S04H2125SP Juego llaves de vaso con 25 piezas de 1/4"
- S04H4131SP Juego llaves de vaso con 31 piezas de 1/2"
- S29H4140SP Juego de 40 puntas de 1/2" y 3/8"

D



S04H46121SV

335.00€

Cajón con llaves de vaso y carraca (cajón completo)

Composición:

- S04H3157SP Juego de llaves de vaso con carraca de 1/4" y 3/8"
- S04H4125SP Juego de llaves de vaso con carraca de 1/2"
- S29H4140SP Juego de 40 puntas de 1/2" y 3/8"

D



Tableros para herramienta en carros

Tableros en espuma de alta densidad EVA



W23559SV

240.00€

Cajón con destornilladores planos/ phillips/ estrella y alicates
(cajón completo)

Composición:

D71PP08SP Juego de destornilladores planos y phillips

W23108SP Juego de llaves estrella acodadas 75°

P0903SP Juego de alicates

S29H4140SP Juego de puntas de 1/2" y 3/8"

D



W26134SV

255.00€

Cajón con llaves de estrella/ mixtas/ alicates (cajón completo)

Composición:

W23108SP Juego de estrella acodadas 75°

P0903SP Juego de alicates

W26112SP Juego de llaves mixtas (fijas/ estrella)

H01SM109S Juego de llaves hexagonales

P28210 Alicata ajustable

P32M10A Alicata de presión

D



W2623431SV

228.00€

Cajón con llaves de estrella y mixtas (cajón completo)

Composición:

W23108SP Juego de estrella acodadas 75°

W24106S Juego de llaves estrella abierta

W26116SP Juego de llaves mixtas fija/estrella

A1050077 Correa para filtros de aceite

D



W26315SV

380.00€

Tablero con 15 llaves mixtas - fija/ estrella (cajón completo)

Composición:

W26 20; 21; 23; 25; 26; 27; 28; 29; 30; 32; 36; 38; 41; 46 y 50mm

D



D70105KV

48.50€

Tablero con 5 destornilladores planos/ phillips (1/3 de cajón)

Composición:

D70S6125 Destornilladores planos 6,5x125mm

D70S8150 Destornilladores planos 8x150mm

D70S9175 Destornilladores planos 9,5x175mm

D70P2100 Destornilladores phillips PH2x100mm

D70P3150 Destornilladores phillips PH3x150mm

A



D70PS119KV

82.00€

Tablero con 5 destornilladores planos/ phillips (1/3 de cajón)

Composición:

3 Destornilladores phillips: PH1x75; PH2x100 y PH3x125

2 Destornilladores planos: 6,5x150 y 9,5x200

1 Giramachos con 13 puntas

A



D71PP08KV

46.50€

Tablero con 8 destornilladores planos/ phillips (1/3 de cajón)

Composición:

D71S Juego de 4 destornilladores planos

6,5x38; 4x80; 5,5x125 y 6,5x150mm

D71P Juego de 4 destornilladores phillips

PH1X80; PH2X38; PH2x100 y PH3x150mm

A

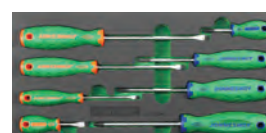

H10MB08KV

51.50€

Tablero con 8 llaves hexagonales con mango (1/3 de cajón)

Composición:

H10MB Juego de 8 llaves macho
2x100; 2,5x100; 3x100; 4x100; 5x150; 6x150, 8x200
y 10x200mm

A



H10MT08KV

53.00€

Tablero con 8 llaves torx tamperproof de mango (1/3 de cajón)

Composición:

H10MT Juego de 8 llaves torx
T10x100; T15x100; T20x100; T25x100; T27x150;
T30x150; T45x200 y T50x200mm

A



M09103KV

65.80€

Tablero con martillos y llave inglesa (1/3 de cajón)

Composición:

M09300 Martillo tipo alemán
M11035 Martillo de goma (anti rebote)
W27AS10 Llave inglesa

A



M63113KV

69.00€

Tablero con botadores, cortafíos, buril y punzón (1/3 de cajón)

Composición:

6 Botadores
4 Cortafíos
1 Buril
1 Punzón de pico
1 Punzón

A



Tableros para herramienta en carros

Tableros en espuma de alta densidad EVA

MHS08KV

69.00€

Tablero con sierra y varios (2/3 de cajón)

Composición:

1 Sierra con 2 láminas extra
1 Cinta métrica 3 mts
1 Regla 330mm
1 Cutter

B



P011804KV

85.00€

Tablero con 4 alicates (1/3 de cajón)

Composición:

P1118 1 Alicate universal
P0918 1 Alicate de corte diagonal
P0118 1 Alicate de puntas
P2710 1 Alicate ajustable

A



P32M105KV

74.00€

Tablero con 5 alicates (1/3 de cajón)

Composición:

AG010002 1 Alicate circlips interiores recto
AG010005 1 Alicate circlips interiores curvo
AG010008 1 Alicate circlips exteriores recto
AG010011 1 Alicate circlips exteriores curvo
P32M10A 1 Alicate de bloqueo

A



S03A4122KV

110.00€

Tablero con 22 llaves de impacto 1/2" (1/3 de cajón)

Composición:

S03A Juego llaves impacto
10; 11; 12; 13; 14; 16; 17; 19; 21; 22 y 24
S03AD Juego llaves impacto larga
10; 11; 12; 13; 14; 16; 17; 19; 21; 22 y 24

A



Tableros para herramienta en carros

Tableros en espuma de alta densidad EVA

S04H2132KV

140.00€

Tablero con 32 piezas, llaves de vaso y prolongadores (1/3 de cajón)

Composición:

- S09H3 Llaves de vaso punta hexagonal 3/8"
- S09H4 Llaves de vaso punta hexagonal 1/2"
- S49H4 Llave de vaso punta estriada 1/2"
- S24H4 Prolongador 1/2" - 125 y 250mm
- S17H4 Llaves de bujías - 16 y 21mm
- S23H4125 Extensión flexible

A



S04H4144KV

135.00€

Tablero con 44 piezas, llaves de vaso con carraca (1/3 de cajón)

Composición:

- R3704 Carraca 1/2"
- R3702 Carraca 1/4"
- S04H4 Llaves de vaso 1/2"
10; 11; 12; 13; 14; 15; 16; 17; 18; 19; 20; 21; 22; 23; 24;
27; 30 y 32mm
- S04H2 Llaves de vaso 1/4"
4; 5; 5,5; 6; 7; 8; 9; 10; 11; 12 y 13mm
- S04HD2 Llaves de vaso larga 1/4"
5; 6; 7; 8; 9; 10; 11; 12 y 13mm
- S24H2 Prolongadores 1/4" - 50 y 150mm
- S26H2150 Mango 1/4"
- S15H472 Cardan 1/4"

A

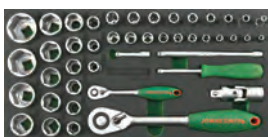

S06H427KV

113.00€

Tablero con 27 puntas de vaso (1/3 de cajón)

Composición:

- S09H3 6x Puntas hexagonales de 3/8"
- S09H4 11x Puntas hexagonales de 1/2"
- S49H4 10x Puntas estriados de 3/8"

A

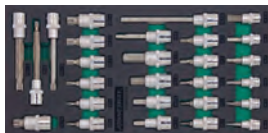

S07H2138KV

88.00€

Tablero con 18 piezas, juego de puntas (1/3 de cajón)

Composición:

- S06H2 7 Llaves de vaso torx int. 1/4": E4; E5; E6; E7; E8; E10 y E11
- S07H2 11 Puntas torx de 1/4": T6; T7; T8; T9; T10; T15; T20 y T25
- S09H2 5 Puntas hexagonais de 1/4": 3, 4, 5 y 6mm
- S10H2 4 Puntas planas 1/4": 3; 4,5; 5,5 y 7mm
- S11H2 4 Puntas phillips 1/4": PH0, PH1; PH2 y PH3
- S12H2 4 Puntas pozi 1/4": PZ0, PZ1, PZ2 y PZ3
- AG010184C 1 Mango flexible 1/4" con caixa 7mm
- AG010184D 1 Mango flexible 1/4" con vaso 8mm
- 1 Mango flexible de 1/4" con vaso

A



S29H4141KV

91.00€

Tablero con 41 piezas, juego de puntas (1/3 de cajón)

Composición:

- Puntas 6 caras
- Puntas torx
- Puntas estriadas
- Porta puntas de 1/2"
- Porta punta de 3/8"
- Llave para clips de zapatas

A



W25106KV

38.00€

Tablero con 6 llaves fijas (1/3 de cajón)

Composición:

- W25 6x7; 8x9; 10x11; 12x13; 14x15 y 16x17

A



W25107KV

92.00€

Tablero con 7 llaves fijas (2/3 de cajón)

Composición:

- W25 18-19; 20-22; 21-23; 24-16; 25-28; 27-30 y 30-32mm

B



Tableros para herramienta en carros

Tableros en espuma de alta densidad EVA

W25110KV 74.00€

Tablero con 10 llaves fijas (1/3 de cajón)

Composición:

W25 6x7; 8x9; 10x11; 12x13; 14x15; 16x17; 18x19; 21x23; 24x27 y 30x32

A

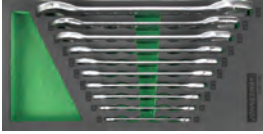

W26108KV 95.00€

Tablero con 8 llaves mixtas - fijas/estrella (2/3 de cajón)

Composición:

W26 18; 19; 21; 22; 24; 27; 30 y 32mm

B



W26110KV 51.00€

Tablero con 10 llaves mixtas - fija/ estrella (1/3 de cajón)

Composición:

W26 6; 7; 8; 10; 11; 12; 13; 14; 16 y 17mm

A



W26116KV 83.00€

Tablero con 16 llaves mixtas - fija/ estrella (1/3 de cajón)

Composición:

W26 6; 7; 8; 9; 10; 11; 12; 13; 14; 15; 16; 17; 18; 19; 22 e 24mm

A



W65105KV 43.50€

Tablero con 5 llaves estrella curvadas (1/3 de cajón)

Composición:

8x10; 10x12; 13x15; 14x17 y 19x22mm

A

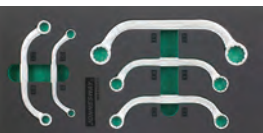

Tableros para herramienta para caja C-6DA4

AG10002SC 65.00€

Juego de machos y terrajas

Composición:

Machos de rosca manuales M3 a M12
Terrajas M3 a M12
Porta terrajas
Giramachos



D376514SC 44.00€

Juego de llaves

Composición:

Destornillador phillips: PH00; PH0 y PH1
Destornillador plano: 2; 2,4 y 3mm
Destornillador torx: T5; T6; T7; T8; T9; T10; T15 y T20



P0813SC 49.00€

Juego de alicates

Composición:

P087 Alicata universal
P097 Alicata de corte
P118 Alicata de puntas



R4811SC 73.00€

Juego de llaves de vaso de 1/4" y 3/8"

Composición/ medidas en mm:

Carraca de 1/4" de 72 dientes
Carraca de 3/8" de 72 dientes
Extensor de 3/8": 75
Extensor de 3/8": 250
Extensor de 1/4": 50
Extensor de 1/4": 150
Cardán de 1/4"
Cardán de 3/8"
Adaptador 1/4" - 3/8"
Adaptador 3/8" - 1/2"
Mango



S04H5129SC

58.00€

Juego de llaves de vaso 6 caras de 1/4 y 3/8" con 28 piezas

Composición/ medidas en mm:

Llaves de vaso de 1/4": 4; 4,4; 5; 5,5; 6; 7; 8; 9; 10; 11; 12 y 13

Llaves de vaso largas: 8; 10; 12 y 13

Llaves de vaso 3/8": 14; 15; 17; 18; 19; 20; 22 y 24

Llaves de vaso largas: 14; 15 y 17

Llaves de bujías 3/8": 16 y 21



V11011SC

48.50€

Juego con remachadora de tuercas

Composición/ medidas en mm:

Alicate remachadora

Boquillas M3 a M6



W25117SC

65.00€

Juego de llaves fijas y macho allen

Composición/ medidas en mm:

Llaves fijas: 8x9; 10x11; 12x13; 14x15; 16x17; 18x19; 20x22 y 24x27

Llaves macho allen: 1,2; 2; 2,5; 3; 4; 5; 6; 8 y 10



W27AT02SC

58.00€

Juego de alicates

Composición/ medidas en mm:

P32M10C Alicata de presión

W27AT10 Llave ajustable



Tableros en espuma EVA aplicables en los carros: C-4DW, C-6DW y C-7D

P-EVA(D70105KV)

11.20€

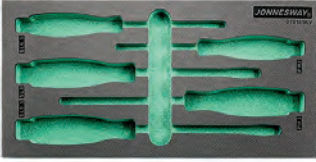

P-EVA(D71PP08KV)

11.70€



P-EVA(D737128SV)

33.50€



P-EVA(D737134SV)

33.50€

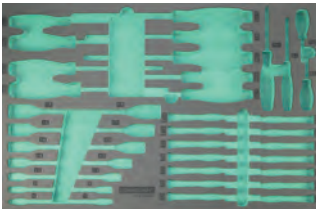

P-EVA(H10MB08KV)

11.30€



P-EVA(H10MT08KV)

11.30€



P-EVA(H10121SV)

33.50€



P-EVA(P82736SV)

34.00€



P-EVA(M09103KV)

11.30€



P-EVA(M63113KV)

11.30€



P-EVA(MHS08KV)

21.30€



P-EVA(P011804KV)

11.30€



P-EVA(P32M105KV)

11.30€



P-EVA(P82714SV)

34.00€



Tableros para herramienta vacios

Tableros en espuma EVA aplicables en los carros: C-4DW, C-6DW y C-7D

P-EVA(S03A4122KV)

11.30€

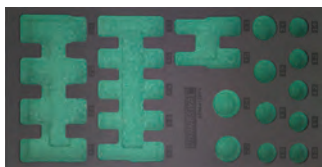

P-EVA(S04H2132KV)

11.30€



P-EVA(S04H4144KV)

11.30€



P-EVA(S04H4295SV)

33.00€

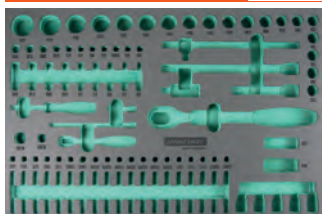

P-EVA(S04H42165SV)

33.00€

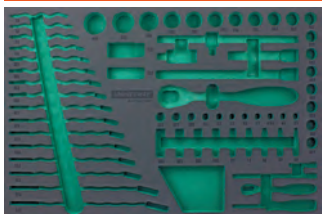

P-EVA(S04H45121SV)

33.00€

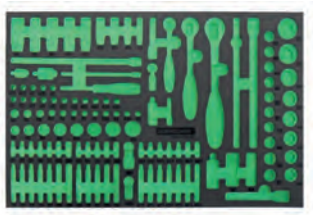

P-EVA(S29H4141KV)

11.30€



P-EVA(W23559SV)

33.50€



P-EVA(W25110KV)

11.30€



P-EVA(W26116KV)

11.30€

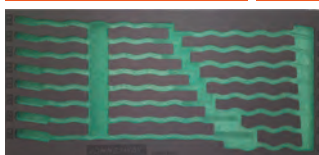

P-EVA(W26134SV)

35.00€



P-EVA(W2623431SV)

33.00€



Tableros para herramienta

Cajas de plástico para tableros

P-B (31)

7.00€

Medidas:

425x185x52mm

B



P-B (41)

5.10€

Medidas:

375x144,5x52mm

A



Tableros para herramienta vacios para composiciones

aplicable a los carros: C-4DW, C-6DW y C-7DW

P-TR(AG010002SP)	2.70€
P-TR(AG010026SP)	2.70€
P-TR(AI10002SP)	2.90€
P-TR(D70105SP)	2.40€
P-TR(D71PP08SP)	2.40€
P-TR(H10MB08SP)	2.80€
P-TR(M09513SP)	2.70€
P-TR(M645114SP)	2.70€
P-TR(P018SP)	2.70€
P-TR(P04704SP)	2.70€
P-TR(P0803SP)	2.70€
P-TR(P0903SP)	2.70€
P-TR(P2710SP)	2.70€
P-TR(S03A4122SP)	2.70€
P-TR(S04H2125SP)	2.40€
P-TR(S04H3157SP)	3.30€
P-TR(S04H3536SP)	3.40€
P-TR(S04H4125SP)	3.20€
P-TR(S04H4524SP)	2.40€
P-TR(S04H4726SP)	3.30€
P-TR(S04H4728SP)	3.20€
P-TR(S06H427SP)	2.40€
P-TR(S09H4118SP)	2.70€
P-TR(S29H4140SP)	3.20€
P-TR(W23108SP)	2.70€
P-TR(W25110SP)	2.40€
P-TR(W26112SP)	2.70€
P-TR(W26116SP)	2.70€



Tableros para herramienta vacios para composiciones

aplicable a la maleta: C-3DH2

P-TR (D70SP06ST)

1.70€

Para llaves D70



P-TR (PC303ST)

1.70€

Para alicates: P087; P106 y P118



P-TR (S04H4120ST)

1.90€

Para llaves de vaso de 1/2" con carraca



P-TR (S04H4506ST)

1.90€

Para prolongadores



P-TR (W26107ST)

1.90€

Para llaves mixtas W26



P-TR (W26920ST)

1.70€

Para para llaves mixtas W26 y llaves de 6 caras



T21
Llave dinamométrica con precisión de: +/- 3%

Ref.	Cuadradillo	Capacidad (Nm)	Longitud (mm)	Precio
T21025N	1/4"	5-25	320	110.00€
T21050N	3/8"	10-50	390	122.00€
T211000N	1"	200-1 000	1 510	575.00€
T21101N	1/2"	20-100	390	145.00€
T21200N	1/2"	40-200	502	130.00€
T21340N	1/2"	60-340	604	155.00€
T21341N	3/4"	60-340	604	165.00€
T21550N	3/4"	110-550	938	375.00€

T25
Llave dinamométrica con precisión de: +/- 4%

Ref.	Cuadradillo	Capacidad (Nm)	Longitud (mm)	Precio
T25100N	3/8"	20-100	390	99.00€
T25200N	1/2"	40-200	502	105.00€
T25340N	1/2"	60-340	604	125.00€

T27
Llave dinamométrica con precisión de: +/- 4%

Ref.	Cuadradillo	Capacidad (Nm)	Longitud (mm)	Precio
T27010N	1/4"	2-10	308	73.00€
T27020N	1/4"	4-20	340	73.00€
T27021N	3/8"	4-20	340	73.00€
T27060N	3/8"	10-60	340	78.00€
T271001N	1"	200-1 000	1 177	535.00€
T27101N	1/2"	20-100	458	84.00€
T27200N	1/2"	40-200	531	93.00€
T27340N	1/2"	60-340	585	102.00€
T27800N	3/4"	150-800	1 177	445.00€

T30200NS
260.00€
Barra dinamométrica con conjunto de 9 puntas fijas -

Precisión: 4%

Composición:

Capacidad: 40-200 Nm

Cabeza: 1/2"

Ajuste: 14x18mm

Puntas: 13; 14; 15; 17; 19; 22; 24; 27 y 30mm

T33
Llave dinamométrica reversible

 Precisión: sentido horario: 5%
 sentido anti-horario: 6%

Ref.	Cuadradillo	Par (Nm)	Precio
T33025N	1/4"	5-25	110.00€
T33050N	3/8"	10-50	115.00€
T33101N	1/2"	20-100	119.00€
T33200N	1/2"	40-200	119.00€
T33341N	3/4"	60-340	157.00€

T10H1210S
330.00€
Juego de llave dinamométrica con 7 llaves intercambiables 14x18

Capacidad: 40-210 Nm

T103
Llave "Pie de Gallo" 14x18

Ref.	Medida (mm)	Precio
T1313	13	16.50€
T10314	14	12.60€
T10315	15	12.60€
T10316	16	12.60€
T10317	17	12.60€
T10318	18	12.60€
T10319	19	12.60€
T10321	21	12.60€
T10322	22	12.60€
T31324	24	19.00€

T290
Cabezal para llave dinamométrica de cabezas intercambiables

Ref.	Cuadradillo	Medida (mm)	Precio
T29002	1/4"	14/18	21.00€
T29014	1/2"	14/18	26.00€
T29016	3/4"	14/18	36.00€



T14200N
250.00€
Llave dinamométrica digital intercambiable con precisión de: +/- 1%

Capacidad: 20-200Nm

Memoria: 10 lecturas

Longitud: 550mm

Unidad: Nm; fb-lb; Kg-m; in-lb

Peso: 1 150g

Baterías: 3x1,5v AA (no incluidas)

Cabeza: 14x18

T24135
350.00€
Llave dinamométrica digital reversible con agarre izquierdo y derecho
Precisión de: +/- 2% a la derecha | +/- 3% izquierda

Par: 6,8-135Nm

Cuadradillo: 3/8"

T24200
340.00€
Llave dinamométrica digital con agarre izquierdo y derecho
Precisión de: +/- 2% a la derecha | +/- 3% izquierda

Capacidad: 10-200Nm

Memoria: 50 lecturas

Longitud: 530mm

Unidad: Nm; fb-lb; Kg-m; in-lb

Cuadradillo: 1/2"

T19
Medidor digital de par con precisión de: +/- 2%

Advertencia de luz y sonido

Ref.	Cuadradillo	Par (Nm)	Precio
T19135N	3/8"	10-135	68.00€
T19200N	1/2"	20-200	70.00€

T19600N
275.00€
Medidor digital de par

Cuadradillo: 3/4"

Par: 60-600 Nm

T
Kits de reparación para llaves dinamométricas

Ref.	Aplicable a los modelos	Precio
T04M060-R	T04M060	7.80€
T04M061-R	T04M061	7.80€
T04M150-R	T04M150	10.10€
T04M250-R	T04M250	13.60€
T07030N-R	T07030N	7.00€
T07110N-R	T07110N	7.90€
T07700N-R	T07700N	52.00€
T102001S-R	T102001S	13.00€
T154100N-R	T154100N	10.10€
T154200N-R	T154200N	14.50€
T16005N-R	T16005N	8.50€
T21025N-R	T21025N	10.00€
T21050N-R	T21050N	11.50€
T211000N-R	T211000N	64.00€
T21101N-R	T21101N	14.50€
T21200N-R	T21200N	13.00€
T21340N-R	T21340N	13.00€
T21341N-R	T21341N	45.00€
T21550N-R	T21550N	45.00€
T24135-R	T24135	21.00€
T24200-R	T24200	24.00€
T25100N-R	T25100N	11.50€
T25200N-R	T25200N	12.50€
T25340N-R	T25340N	12.50€
T27-D2R	T27010N, T27020N, T27030N	7.70€
T27-D3R	T27021N, T27031N, T27060N, T27100N	8.20€
T27-D4R1	T27101N	9.70€
T27-D4R2	T27200N, T27340N	11.20€
T27-D6R	T27500N, T27600N, T27800N, T271000N	27.50€
T27-D8R	T27801N, T271001N	46.50€
T33025N-R	T33025N	11.00€
T33050N-R	T33050N	13.00€
T33101N-R	T33101N	14.00€
T33200N-R	T33200N	14.00€
T33341N-R	T33341N	15.50€

R12
Carraca reversible de 60 dientes

Ref.	Cuadradillo	Longitud (mm)	Precio
R1206N	3/4"	500	64.00€
R12081	1"	675	139.00€

R29

Carraca reversible de 36 dientes



Ref.	Cuadradillo	Longitud (mm)	Precio
R2902	1/4"	146	13.50€
R2904	1/2"	278	20.50€

R34

Carraca de 72 dientes con mango antideslizante



Ref.	Cuadradillo	Longitud (mm)	Par (Nm)	Precio
R3403	3/8"	196	245	21.50€

R35

Carraca de 72 dientes con mango antideslizante



Ref.	Cuadradillo	Comp. (mm)	Par (Nm)	Precio
R3502	1/4"	135	68	17.00€
R3503	3/8"	199	245	21.00€
R3504	1/2"	250	647	25.00€

R36

Carraca de metal reversible de 48 dientes



Ref.	Cuadradillo	Longitud (mm)	Par (Nm)	Precio
R3602	1/4"	128	68	15.80€
R3603	3/8"	198	245	17.70€

R37

Carraca reversible de 48 dientes con mango antideslizante

Ref.	Cuadradillo	Longitud (mm)	Par (Nm)	Precio
R3702	1/4"	135	68	16.70€
R3703	3/8"	198	245	21.00€
R3704	1/2"	353	647	24.80€



R37B

Carraca reversible corto de 48 dientes con mango antideslizante



Ref.	Cuadradillo	Longitud (mm)	Par (Nm)	Precio
R3702B	1/4"	110	68	16.10€
R3704B	1/2"	180	647	22.50€

R41

Carraca reversible y articulado de 36 dientes con mango antideslizante



Ref.	Cuadradillo	Longitud (mm)	Precio
R4103	3/8"	238	20.50€
R4104	1/2"	288	25.50€

R45

Carraca reversible y rotativo de 48 dientes



Ref.	Cuadradillo	Longitud (mm)	Precio
R4502	1/4"	185	35.00€

R48

Carraca reversible de 72 dientes



Ref.	Cuadradillo	Longitud (mm)	Precio
R4802	1/4"	146	14.50€
R4803	3/8"	185	16.50€
R4804	1/2"	278	21.40€

R48

Carraca reversible de metal de 72 dientes



Ref.	Cuadradillo	Longitud (mm)	Precio
R4802A	1/4"	125	12.00€
R4804A	1/2"	250	20.00€

R48

Carraca reversible corto de 72 dientes

Ref.	Cuadradillo	Longitud (mm)	Peso (g)	Precio
R4802B	1/4"	110	100	13.00€
R4804B	1/2"	170	442	19.50€

R51

Carraca reversible y extensible de 72 dientes con mango antideslizante

Ref.	Cuadradillo	Longitud (mm)	Peso (g)	Precio
R5103	3/8"	220-230	440	21.00€
R5104	1/2"	300-400	930	26.70€

R66

Carraca de cable giratorio de 60 dientes

Ref.	Cuadradillo	Longitud (mm)	Peso (g)	Precio
R6602	1/4"	180	181	39.50€
R6603	3/8"	290	645	44.00€
R6604	1/2"	240	384	52.00€

R68

Carraca reversible de bajo perfil de 60 dientes

Ref.	Cuadradillo	Peso (g)	Precio
R6802	1/4"	165	17.00€
R6803	3/8"	265	21.50€
R6804	1/2"	520	25.00€

RD01
15.30€

Mini carraca

Cuadradillo: 1/4"
Dientes: 60
Longitud: 200mm

RD02
18.00€

Mini carraca flexible

Cuadradillo: 1/4"
Dientes: 60
Longitud: 170mm

T094602
330.00€

Carraca desmultiplicador 1/2" - 3/4" R 1:9

Par máximo: 1 500 Nm

T094602-RK
260.00€

Kit de reparación

T096801
345.00€

Carraca desmultiplicador 3/4" - 1" R 1:4

Par máximo: 2 500 Nm

T096801-RK
280.00€

Kit de reparación

T351060
145.00€

Atornillador dinámico 1 a 6Nm

Composición:

- Destornillador: 1-6 Nm
- Adaptador 1/4"
- 4 Puntas phillips: PH0; PH1; PH2 y PH3
- 4 Puntas planas: 3; 4; 5 y 6mm
- 5 Puntas torx: 10; 15; 20; 25 y 30
- 6 Puntas hexagonales: 1.5; 2; 3; 4; 5 y 6mm

R

Kits de reparación para carracas

Ref.	Aplicable a los modelos	Precio
R1206N-R	R1206N	25.00€
R1206R	R1206	23.00€
R2902RK	R2902; R2902A; R2902B	6.00€
R2903RK	R2903; R2903A; R2903B ; R4103	6.50€
R2904RK	R2904; R2904A; R2904B ; R4104	7.30€
R3602RK	R3602; R3702; R3702B; R3802	8.80€
R3603RK	R3603; R3703; R3803	11.30€
R3604RK	R3604; R3704; R3704B; R3804	12.50€
R3402RK	R3402; R3502	8.50€
R3403RK	R3403; R3503	10.50€
R3404RK	R3404; R3504	11.80€
R4502RK	Para cabezal de carraca	7.70€
R4502JRK	Para articulación	7.70€
R4802RK	R4802	5.90€
R4804RK	R4804	7.20€
R5103RK	R5103	6.50€
R5104RK	R5104	9.00€
R5802ERK	R5802E	10.60€
R5803RK	R5803	13.00€
R5804ERK	R5804E	16.50€
R5804LRK	R5804L	16.70€
R6802RK	R68	10.00€
R6803RK	R68	12.70€
R6804RK	R68	13.00€
R12081RK	R12081	65.00€



W24A107S

100.00€

Juego 7 llaves estrella abierta flexible

Composición:

Llaves: 8x8; 10x10; 11x11; 12x12; 13x13; 14x14 y 17x17

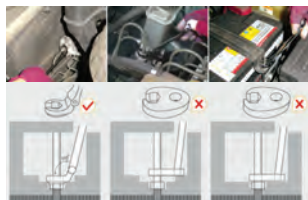

W45

Llave mixta fija/ carraca



Ref.	Medida (mm)	Longitud (mm)	Precio
W45108	8	135,40	8.80€
W45109	9	159,50	9.30€
W45110	10	159,50	9.30€
W45111	11	165,90	9.30€
W45112	12	168,60	9.50€
W45113	13	178,50	10.00€
W45114	14	190,50	10.50€
W45115	15	199,40	12.00€
W45116	16	206,40	12.30€
W45117	17	225,40	13.20€
W45118	18	236,40	14.50€
W45119	19	247,40	14.50€
W45121	21	281,00	22.00€
W45122	22	281,00	24.00€
W45124	24	281,00	25.00€
W45127	27	330,00	38.30€
W45130	30	425,00	49.50€
W45132	32	425,00	50.50€

W45110S

94.00€

Juego de llaves fijas/ carraca de 9 piezas

Composición:

W45 Llaves: 8; 10; 12; 13; 17 y 19mm
Adaptadores 1/4"; 3/8" y 1/2"
Porta puntas



W45117S

340.00€

Juego de llaves mixtas fija/ carraca con 72 dientes de 17 piezas

Composición:

W45 Llaves: 8; 10; 12; 13; 14; 17; 19; 21; 22; 24; 27; 30 y 32mm
Adaptadores 1/4"; 3/8"; 1/2" y 3/4"
Porta puntas
Maletín



W45316S

160.00€

Juego de llaves mixtas fija/ carraca con 72 dientes de 16 piezas

Composición:

W45 Llaves: 8 a 19mm
Adaptadores 1/4"; 3/8" y 1/2"
Porta puntas
Maletín



W45316S-AD

16.00€

Conjunto de 4 adaptadores

Composición:

Adaptadores 1/4"; 3/8" y 1/2"
Porta puntas



W45316S-AD12

5.50€

Adaptador 1/2" para llave de 19mm



W45316S-AD14

3.90€

Adaptador 1/4" para llave de 10mm



W45316S-AD34

15.00€

Adaptador 3/4" para llave de 32mm



W45316S-AD38

4.50€

Adaptador 3/8" para llave de 13mm



W45316S-ADBH14

1.75€

Porta puntas 1/4" para llave de 10mm



W51110S
118.00€
Juego de 10 llaves cortas fija/ carraca

Composición:

W51 Llaves: 8; 10; 11; 12; 13; 14; 15; 16; 17 y 19mm

W52105S
90.00€
Juego de 5 llaves cortas fija/ carraca flexible

Composición:

W52 Llaves: 8; 10; 12; 14 y 17mm

W66
Llave fija/ carraca flexible

Ref.	Medida (mm)	Longitud (mm)	Precio
W66108	8	137	15.00€
W66109	9	159	15.00€
W66110	10	159	15.70€
W66111	11	175	16.00€
W66112	12	175	16.00€
W66113	13	186	17.50€
W66114	14	194	18.80€
W66115	15	216	18.80€
W66116	16	216	20.20€
W66117	17	232	20.70€
W66118	18	250	21.50€
W66119	19	250	22.00€
W66121	21	250	31.50€
W66124	24		38.30€

W66107S
118.00€
Juego de 7 llaves fija/ carraca flexible

Composición:

W66 Llaves: 8; 10; 11; 13; 14; 17 y 19mm

W66116S
230.00€
Juego de llaves mixtas fija/ carraca flexible de 72 dientes con 16 piezas

Composición:

W66 Llaves: 8 a 19mm
 Adaptadores 1/4"; 3/8" y 1/2"
 Porta de puntas
 Maletín

W67104S
63.00€
Juego de llaves estrella (torx) con carraca

Composición:

 Llaves: E6xE8; E10xE12;
 E14xE18 y E20xE24mm

W68
Llave carraca de 72 dientes

Ref.	Medida (mm)	Precio
W680809	8x9	14.50€
W680810	8x10	15.00€
W681011	10x11	15.80€
W681213	12x13	15.80€
W681415	14x15	18.50€
W681618	16x18	19.00€
W681719	17x19	21.00€

W68106S
95.00€
Juego de llaves carraca de 72 dientes con 6 piezas

Composición:

W68 Llaves: 8x9; 10x11; 12x13;
 14x15; 16x18 y 17x19

W73
Llave 4 en 1 con carraca

Ref.	Medida (mm)	Precio	
W7310813	8x10	12x13	22.00€
W7311419	14x17	18x19	27.80€



W73102S

47.20€

Juego de llaves con carraca 4 en 1

Se puede utilizar en 4 medidas

Composición/ medidas en mm:

Llave 8x10 - 12x13

Llave 14x17 - 18x19



W91107S

94.00€

Juego de llaves mixtas fija especial/ carraca de 72 dientes

Composición:

Llaves: 10; 12; 13; 14; 15; 17 y 19mm



W91



Llave fija especial/ estrella con carraca de 72 dientes

Ref.	Medida (mm)	Longitud (mm)	Precio
W91110	10	159,5	10.00€
W91112	12	168,6	11.00€
W91113	13	178,5	11.50€
W91114	14	190,5	11.80€
W91115	15	199,4	13.00€
W91117	17	225,4	15.00€
W91119	19	247,4	15.50€

W93108S

130.00€

Juego de llaves mixtas con carraca reversible y anillo de retención

Composición:

Llaves: 10; 11; 12; 13; 14; 15;

17 y 19mm



W93



Llave mixta fija carraca con anillo retención

Ref.	Medida (mm)	Longitud (mm)	Precio
W93110	10	158	13.20€
W93111	11	164	13.80€
W93112	12	167	14.80€
W93113	13	177	15.00€
W93114	14	189,4	16.20€
W93115	15	198	17.30€
W93117	17	224	20.00€
W93119	19	245	22.50€

W61

Llave de estrella larga

Ref.	Medida (mm)	Longitud (mm)	Precio
W611011	10x11	295	10.50€
W611214	12x14	330	12.00€
W611315	13x15	370	15.00€
W611618	16x18	405	16.60€
W611719	17x19	405	16.60€
W612224	22x24	435	24.50€



W61106S

105.00€

Juego de 6 llaves estrella largas

Se suministra en una bolsa de plástico con divisiones

Composición:

Medida	Longitud (mm)
10x11	235
12x14	330
13x15	370
16x18	405
17x19	405
22x24	435



W62

Llave de estrella derecha

Ref.	Medida (mm)	Longitud (mm)	Precio
W6210607	6x7	120	4.00€
W6210809	8x9	135	4.40€
W6211011	10x11	150	4.50€
W6211213	12x13	165	5.50€
W6211415	14x15	210	5.70€
W6211617	16x17	210	6.60€
W6211819	18x19	225	7.10€
W6212022	20x22	240	8.00€
W6212427	24x27	270	13.70€
W6212528	25x28	285	14.40€
W6213032	30x32	335	16.50€



W62108S
58.00€
Juego de 8 llaves estrella derecha

Composición:

W62 Llaves: 6x7; 8x9; 10x11; 12x13;
14x15; 16x17; 18x19 y 20x22mm

W23
Llave de estrella acodada 75°

Ref.	Medida (mm)	Longitud (mm)	Precio
W230607	6x7	168	4.00€
W230809	8x9	183	4.30€
W230810	8x10	183	4.90€
W231011	10x11	198	5.00€
W231113	11x13	217	5.60€
W231213	12x13	217	5.80€
W231317	13x17	217	7.00€
W231415	14x15	239	7.10€
W231617	16x17	260	7.40€
W231719	17x19	292	7.90€
W231819	18x19	292	8.40€
W231922	19x22	318	9.50€
W232022	20x22	318	10.20€
W232123	21x23	327	11.50€
W232224	22x24	327	11.80€
W232426	24x26	329	12.50€
W232427	24x27	329	12.80€
W232528	25x28	347	12.90€
W233032	30x32	362	16.30€

W23108S
58.00€
Juego de 8 llaves de estrella acodada 75°

Se suministra en una bolsa de plástico con divisiones

Composición:

W23 Llaves: 6x7; 8x9; 10x11; 12x13;
14x15; 16x17; 18x19 y 20x22mm

W24
Llave de estrella abierta

Ref.	Medida (mm)	Caras	Longitud (mm)	Precio
W240809	8x9	6	145	3.40€
W241011	10x11	6	152	3.50€
W241012	10x12	6	152	3.70€
W241213	12x13	6	165	4.00€
W241214	12x14	6	178	4.00€
W241314	13x14	6	178	4.10€
W241417	14x17	6	196	5.30€
W241617	16x17	12	196	5.60€
W241719	17x19	12	210	6.30€
W241819	18x19	12	210	6.90€
W241922	19x22	12	233	8.30€
W242224	22x24	12	252	10.70€
W242427	24x27	12	265	13.20€
W242528	25x28	12	265	13.20€
W243032	30x32	12	285	14.70€

W24106S
37.00€
Juego de 6 llaves de estrella abierta

Se suministra en una bolsa de plástico con divisiones

Composición:

W24 Llaves: 8x9; 10x11; 10x12;
13x14; 16x17 y 17x19mm

W24N
Llave de estrella abierta con tapa

Ref.	Medida (mm)	Longitud (mm)	Precio
W24N0810	8x10	122	7.70€
W24N1113	11x13	143	9.00€
W24N1214	12x14	145	9.20€
W24N1719	17x19	162	13.00€



W25



Llave fijas

Ref.	Medida (mm)	Longitud (mm)	Precio
W250607	6x7	123	2.40€
W250608	6x8	123	2.40€
W250809	8x9	140	2.60€
W251011	10x11	156	2.80€
W251012	10x12	156	2.80€
W251213	12x13	172	3.30€
W251214	12x14	180	3.30€
W251415	14x15	190	3.70€
W251417	14x17	195	4.10€
W251617	16x17	205	4.30€
W251618	16x18	205	4.40€
W251719	17x19	221	5.00€
W251819	18x19	221	5.00€
W251922	19x22	237	6.30€
W252022	20x22	237	6.30€
W252123	21x23	247	6.70€
W252224	22x24	247	7.00€
W252426	24x26	263	8.50€
W252427	24x27	263	8.60€
W252528	25x28	279	10.50€
W252730	27x30	283	11.40€
W252732	27x32	289	11.50€
W253032	30x32	298	11.50€
W253236	32x36	330	22.00€
W253641	36x41	380	28.00€
W253842	38x42	380	28.40€
W254146	41x46	415	40.00€
W254650	46x50	430	58.00€

W25108S

40.00€

Juego de 8 llaves fijas

Se suministra en una bolsa de plástico con divisiones

Composición:

W25 Llaves: 6x7; 8x9; 10x11; 12x13; 14x15; 16x17; 18x19 y 20x22mm



W26



Llave mixta fija/ estrella

Ref.	Medida (mm)	Precio
W26106	6	2.20€
W26107	7	2.30€
W26108	8	2.35€
W26109	9	2.45€
W26110	10	2.75€
W26111	11	2.75€
W26112	12	3.00€
W26113	13	3.30€
W26114	14	3.40€
W26115	15	3.90€
W26116	16	4.00€
W26117	17	4.70€
W26118	18	5.10€
W26119	19	5.60€
W26120	20	6.20€
W26121	21	6.70€
W26122	22	7.00€
W26123	23	7.70€
W26124	24	8.10€
W26125	25	8.80€
W26126	26	9.30€
W26127	27	10.00€
W26128	28	10.60€
W26129	29	11.50€
W26130	30	12.20€
W26132	32	13.30€
W26134	34	23.30€
W26136	36	29.00€
W26138	38	36.00€
W26141	41	43.00€
W26142	42	43.50€
W26144	44	52.50€
W26146	46	53.00€
W26148	48	69.00€
W26150	50	73.00€
W26155	55	112.00€
W26160	60	155.00€
W26165	65	205.00€

W26

Juego de llaves mixtas fija/ estrella

Se suministra en una bolsa de plástico con divisiones

Ref.	Llaves	Medida (mm)	Precio
W26112S	12xW26	8 a 17; 19 y 22	57.00€
W26114S	14xW26	10 a 14; 16; 17; 19; 21; 22; 24; 27; 30 y 32	92.00€
W26126S	12xW26	6 a 32	184.00€



W26411PRS

65.00€

Juego de 11 llaves mixtas largas

Se suministra en una bolsa de plástico con divisiones

Composición:

W264 Llaves: 7; 8; 9; 10; 11; 12; 13; 14; 15; 17 y 19mm

W26414S

152.00€

Juego de 14 llaves mixtas fija/ estrella SAE

Se suministra en una bolsa de plástico con divisiones

Composición:

W26 Llaves: 3/8"; 7/16"; 1/2"; 9/16"; 5/8"; 11/16"; 13/16"; 7/8"; 15/16"; 1"; 1-1/16"; 1-1/8"; 1-1/4"

W29
Llave estrella para tornillos torx

Ref.	Medida	Longitud (mm)	Precio
W290608	E6xE8	112	6.30€
W290711	E7xE11	125	7.50€
W291012	E10xE12	140	7.50€
W291418	E14xE18	180	7.50€
W291622	E16xE22	200	8.10€
W292024	E20xE24	224	8.10€

W39
Llave fijas de perfil fino

Ref.	Medida (mm)	Longitud (mm)	Precio
W391011	10x11	175	5.20€
W391213	12x13	210	6.50€
W391415	14x15	210	6.50€
W391617	16x17	250	9.50€
W391819	18x19	250	9.80€

W39108SA

75.00€

Juego de 8 llaves fijas de perfil fino

Composición:

W39 Llaves: 6x7; 8x9; 10x11; 12x13; 14x15; 16x17; 18x19 y 20x22mm

W69116S

137.00€

Juego de 16 llaves mixtas 75°

Composición:

W69 Llaves: 7; 8; 9; 10; 11; 12; 13; 14; 15; 16; 17; 18; 19; 21; 22 y 24mm

S57
Llaves de pipa

Ref.	Medida (mm)	Precio
S57H108	8	8.00€
S57H109	9	9.60€
S57H110	10	10.20€
S57H111	11	10.40€
S57H112	12	12.50€
S57H113	13	16.00€
S57H115	15	16.00€
S57H116	16	16.50€
S57H117	17	18.50€
S57H118	18	18.50€
S57H119	19	19.50€
S57H121	21	26.50€
S57H122	22	34.00€
S57H123	23	34.00€
S57H124	24	37.50€
S57H125	25	38.00€
S57H127	27	49.00€
S57H132	32	64.00€

S57H108S

118.00€

Juego de 8 llaves de pipa

Se suministra en una bolsa de plástico con divisiones

Composición:

S57 Llaves: 8; 10; 11; 13; 16; 17; 18 y 19mm

W65
Llave de estrella curvada para motores de arranque

Ref.	Medida (mm)	Precio
W6510810	8x10	3.80€
W6511012	10x12	4.10€
W6511315	13x15	4.50€
W6511417	14x17	5.50€
W6511922	19x22	7.40€



W65A

Llave de estrella curvada



Ref.	Medida	Longitud (mm)	Precio
W65A1012	10x12	141	8.00€
W65A1214	12x14	166	9.20€
W65A1315	13x15	190	12.50€
W65A1618	16x18	220	13.90€
W65A1719	17x19	220	14.80€
W65A1922	19x22	256	18.00€
W65A2224	22x24	22.00€	

W65A105S

65.00€

Juego de 5 llaves estrella curvadas

Composición:

W65A Llaves: 10x12; 12x14; 13x15; 16x18 y 17x19mm



W43A

Llave de vaso flexible



Ref.	Medida (mm)	Longitud (mm)	Precio
W43A0607	6x7	180	5.60€
W43A0809	8x9	180	5.70€
W43A1011	10x11	202	5.90€
W43A1213	12x13	222	7.20€
W43A1415	14x15	245	7.90€
W43A1617	16x17	260	9.50€
W43A1819	18x19	280	12.00€

W43A106S

55.00€

Juego de 6 llaves de vaso flexible

Composición:

W43A Llaves: 8x9; 10x11; 12x13; 14x15; 16x17 y 18x19mm
Maletín



W77A

Llave de estrella 70° para prolongador



Utilice prolongador de serie W77A

Ref.	Medida (mm)	Longitud (mm)	Precio
W77A124	24	180	20.20€
W77A127	27	190	23.30€
W77A130	30	200	27.00€
W77A132	32	235	31.70€
W77A136	36	245	37.70€
W77A138	38	245	39.00€
W77A141	41	265	46.00€
W77A146	46	280	54.50€
W77A150	50	290	56.50€
W77A155	55	300	83.00€
W77A160	60	345	109.00€
W77A165	65	355	132.00€

W77H

Prolongador para llave W77A



Utilizable en conjunto con las llaves de serie W77A

Ref.	Medida (mm)	Utilizar en (mm)	Precio
W77H01	480	24~30	25.00€
W77H02	610	32~41	39.00€
W77H03	760	46~55	68.00€
W77H04	860	60~65	86.00€

WFS46

32.70€

Llave para filtro del diferencial

Incluye llave hexagonal de 5mm

Medida: 46mm

Estriado de 12 caras

Aplicación: VW: Bora, Golf IV, Sharan
Skoda: Octavia



W67

Llave fija de impacto



Ref.	Medida (mm)	Longitud (mm)	Precio
W67119	19	177	6.00€
W67121	21	177	6.00€
W67124	24	197	7.20€
W67130	30	243	11.50€
W67132	32	273	14.50€
W67136	36	299	23.00€
W67138	38	299	24.50€
W67141	41	339	31.00€
W67145	45	374	35.50€
W67146	46	374	36.50€
W67150	50	417	47.00€
W67155	55	496	68.50€
W67160	60	496	68.50€
W67165	65	496	69.00€
W67170	70	496	111.00€

W72
Llave de estrella de impacto

Ref.	Medida (mm)	Longitud (mm)	Precio
W72117	17	160	9.10€
W72118	18	160	9.10€
W72119	19	160	9.20€
W72121	21	160	9.30€
W72122	22	163	9.30€
W72124	24	163	9.70€
W72127	27	180	11.00€
W72130	30	190	14.00€
W72132	32	190	15.00€
W72134	34	205	20.70€
W72136	36	205	21.30€
W72141	41	230	26.00€
W72146	46	240	33.50€
W72150	50	255	46.00€
W72155	55	360	62.00€
W72170	70	335	151.00€

W27AR
Llave inglesa

Ref.	Apertura (mm)	Longitud (mm)	Precio
W27AR8	26,9	200	28.50€
W27AR10	34	250	36.00€

W27AL
Llave inglesa

Mayor capacidad de apertura, más fina y ligera

Ref.	Medida (mm)	Apertura (mm)	Peso (mm)	Longitud (mm)	Precio
W27AL10	250	43	277	256	31.40€

W27AS
Llave inglesa

Ref.	Apertura (mm)	Longitud (mm)	Precio
W27AS8	20	150	15.50€
W27AS10	29	250	18.50€
W27AS15	43	380	49.00€
W27AS18	53	450	81.00€

W27AT
Llave ajustable con mango antideslizante

Ref.	Medida (mm)	Longitud (mm)	Precio
W27AT8	24	200	22.00€
W27AT10	29	250	26.00€
W27AT12	34	300	31.00€
W27AT15	43	375	60.00€

W27AK8
33.50€
Llave inglesa sistema dual (métrico/SAE)

Longitud: 200mm



Herramienta manual

Herramienta SUPERTECH

W28HD

Llave de grifa pico de halcón

Ref.	Apertura (mm)	Longitud (mm)	Precio
W28HD8	10-22	200	34.00€



W28

Llave de grifa

Ref.	Apertura (mm)	Longitud (mm)	Precio
W2808	25,5	200	17.50€
W2810	38	250	19.50€
W2812	51	300	25.50€
W2814	51	350	31.50€
W2818	63,5	450	45.00€
W2824	76	600	74.00€
W2836	127	900	165.00€



W28RJ-HL

Garras de repuesto

Ref.	Aplicable modelo	Precio
W2810RJ-HL	W2810	6.10€
W2812RJ-HL	W2812	7.30€
W2814RJ-HL	W2814	8.00€
W2818RJ-HL	W2818	10.80€
W2824RJ-HL	W2824	16.70€
W2836RJ-HL	W2836	35.00€

S68H2141S

59.00€

Juego de 41 piezas de 1/4" SUPERTECH

Composición/ medidas en mm:

R2902 Carraca de 36 dientes
Llaves de vaso: 4; 4,5; 5; 5,5; 6; 7; 8; 9; 10; 11; 12; 13 y 14
Llaves hexagonales: 1,5; 2 y 2,5
20 Puntas
Prolongador de 50
Extensión flexible
Adaptador hexagonal
Mango



S68H4127S

132.00€

Juego de 27 piezas de 1/2" SUPERTECH

Composición/ medidas en mm:

R2904 Carraca de 36 dientes
Llaves de vaso: 8 a 24; 27; 30 y 32
Llaves de bujías: 16 y 21
Cardán
Prolongador de 125 y 250
Extensión flexible



S68H

Llave de vaso 1/4" SUPERTECH

Ref.	Métrica (mm)	SAE	Par	Precio
S68H2103	3	1/8"	E4	0.85€
S68H2104	4	5/32"	E5	0.85€
S68H21045	4,5			0.85€
S68H2105	5	3/16"	E6	0.85€
S68H21055	5,5	7/32"	E7	0.85€
S68H2106	6		E8	0.90€
S68H21065	6,5	1/4"	E8	0.90€
S68H2107	7	9/32"		0.90€
S68H2108	8	5/16"	E10	0.95€
S68H2109	9	11/32"	E11	0.95€
S68H2110	10	3/8"	E12	0.95€
S68H2111	11	7/16"	E14	1.00€
S68H2112	12	15/32"		1.10€
S68H2113	13	1/2"	E16	1.10€
S68H2114	14	9/16"	E18	1.30€



Herramienta SUPERTECH
S68H5234111S
340.00€
Juego de 111 piezas de 1/4", 3/8" y 1/2" SUPERTECH

Composición/ medidas en mm:

- R3702 Carraca de 1/4"
- R3703 Carraca de 3/8"
- R3704 Carraca de 1/2"
- Llaves de vaso de 1/4": 3,2 a 13
- Llaves de vaso de 3/8": 9 a 19
- Llaves de vaso de 1/2": 14 a 32
- Llaves de bujías de 3/8": 14 y 18
- Llaves de bujías de 1/2": 16 y 21
- Llaves hexagonales: 1,5; 2 y 2,5
- Llaves mixtas fija/ estrella: 8 a 19
- Puntas de 1/4" plana/ phillips/ torx/ hexagonal/pozi
- Puntas de 5/16" plana/ phillips/ torx/ hexagonal/pozi
- Adaptador puntas 5/16"
- Cardán de 1/4"; 3/8" y 1/2"
- Prolongadores de 1/4" con 50 y 150
- Prolongadores de 3/8" con 75 y 150
- Prolongadores de 1/2" con 125 y 250
- Adaptador para extensión flexible de prolongador
- Mango

W84108S
60.00€
Juego de 8 llaves mixta fija/ estrella SUPERTECH

Llaves: 8; 10; 11; 12; 13; 14; 17 y 19mm

W84114S
94.00€
Juego de 14 llaves mixta fija/ estrella SUPERTECH

Llaves: 6 a 19mm

W84
Llaves mixta fija/ estrella SUPERTECH

Ref.	Medida (mm)	Precio
W84106	6	4.10€
W84107	7	4.20€
W84108	8	4.30€
W84109	9	4.50€
W84110	10	4.80€
W84111	11	5.10€
W84112	12	5.50€
W84113	13	5.90€
W84114	14	6.30€
W84115	15	7.10€
W84116	16	7.60€
W84117	17	8.40€
W84118	18	9.00€
W84119	19	9.90€

W86112S
219.00€
Juego de 12 llaves mixta fija/ carraca SUPERTECH

Llaves: 8 a 19mm



S03H2327S

68.50€

Juego de llaves y puntas de vaso de 1/4" con 27 piezas

Composición/ medidas en mm:

- Llave mixta fija/carraca
- Mini llaves 13mm: 4; 4,5; 5; 5,5; 6; 7; 8; 9; 10; 11; 12; 13 y 14
- Puntas hexagonales: 3; 4; 5 y 6mm
- Puntas phillips: PH1; PH2 y PH3
- Puntas planas: 5,5 y 7mm
- Cardán
- Prolongador 50mm
- Extensión flexible 115mm

S04H2118S

39.00€

Juego de llaves de vaso de 1/4" con 18 piezas

Composición/ medidas en mm:

- R2902 Carraca de 36 dientes
- S04H2 Llaves de vaso: 4; 4,5; 5; 5,5; 6; 7; 8; 9; 10; 11; 12 y 13
- S24H2 Prolongadores de 2" y 4"
- S23H2 Extensión flexible
- S15H240 Adaptador universal
- S22H2130 Mango flexible

S04H2141S

71.00€

Juego de llaves de vaso de 1/4" con 41 piezas

Composición/ medidas en mm:

- R3702 Carraca de 48 dientes
- S04H2 Llaves de vaso: 4; 5; 5,5; 6; 7; 8; 10; 11; 12 y 13
- S04HD2 Llaves de vaso largas: 7; 8 y 10
- Llaves macho hexagonales: 1,5; 2; 2,5 y 3
- S09H2 Puntas hexagonales: 3; 4; 5 y 6
- S07H2 Puntas torx: T10; T20; T25; T27; T30 y T40
- S10H2 Puntas planas: 0,8x4; 10x5,5 y 1,2x7
- S11H2 Puntas phillips: PH1; PH2 y PH3
- S24H Prolongadores de 2" y 6"
- S28H1 Mango
- S15H240 Adaptador universal
- S27H2150 Extensor flexible 6"
- S16H3814 Adaptador 3/8 (F) x 1/4" (M)
- Maletín en metal

S04H3125S

75.00€

Juego de llaves de vaso de 3/8" con 25 piezas

Composición/ medidas en mm:

- R3703 Carraca de 48 dientes
- Llaves de vaso: 6 a 22
- Llaves de bujías: 16 y 21
- S24H Prolongadores de 75 y 150
- S23H31200 Extensión flexible de 200
- S15H356 Cardán
- Maletín en metal

S04H3141S

116.00€

Juego de llaves de vaso de 3/8" con 40 piezas

Composición/ medidas en mm:

- R3703 Carraca de 48 dientes
- S04H3 Llaves de vaso: 6 a 24
- Llaves de vaso largas: 14; 15; 17 y 19
- Puntas torx: T10; T20; T25; T27; T30; T40; T45 y T50
- Puntas planas: 0,8x4; 1x5,5 y 1,2x8
- Puntas phillips: PH1; PH2 y PH3
- 2 Prolongadores
- Cardán
- Adaptador universal
- Maletín de transporte

S04H3157S

135.00€

Juego de llaves de vaso de 1/4" y 3/8" con 56 piezas

Composición/ medidas en mm:

- R3702 Carraca 1/4" de 48 dientes
- R3703 Carraca 3/8" de 48 dientes
- S04H2 Llaves de 1/4": 4; 4,5; 5; 5,5; 6; 7; 8; 9; 10; 11; 12 y 13
- S04HD2 Llaves largas de 1/4": 8; 10; 12; y 13
- S04H3 Llaves de 3/8": 14; 15; 17; 18; 19; 20; 22 y 24
- S04HD3 Llaves largas 3/8": 14; 15 y 17
- S17H3 Vaso de bujías 3/8": 16 y 21
- S09H2 Puntas hexagonales: 3; 4; 5 y 6
- S07H2 Puntas torx: T10; T15; T20; T25; T27 y T30
- S10H2 Puntas planas: 4; 5,5 y 7
- S11H2 Puntas phillips: PH1; PH2 y PH3
- S24H2 2 Prolongadores 1/4" (50mm + 150mm)
- S24H3 2 Prolongadores 3/8" (75mm + 250mm)
- S16H302 Adaptador de extensor 1/4" - 3/8"
- S16H403 Adaptador de extensor 1/2" - 3/8"
- S15H356 Adaptador universal 3/8"
- S15H240 Adaptador universal 1/4"



S04H3536S

105.00€

Juego de llaves de vaso de 3/8" con 36 piezas

Composición/ medidas en mm:

- R3503** Carraca de 72 dientes
 Llaves de vaso: 6 a 22mm
 Llaves mixtas: 7 a 17mm
 Vaso de bujías: 16 y 21mm
 Prolongadores de 75; 150 y 225mm
 Cardán
S16H403 Adaptador
 Maletín en metal



S04H6115S

215.00€

Juego de llaves de vaso de 3/4" con 14 piezas

Composición/ medidas en mm:

- Carraca
 Llaves de vaso: 22; 24; 27; 30; 32; 36; 38; 41; 46 y 50
 Prolongador de 100 y 200
 Extensión flexible



S04H4125S

112.00€

Juego de llaves de vaso de 1/2" con 25 piezas

Composición/ medidas en mm:

- R3704** Carraca de 48 dientes
S04H4 Llaves de vaso: 10 a 24; 27; 30 y 32
 Llaves de bujías: 16 y 21
 Prolongadores de 5" y 10"
 Extensión flexible
 Adaptador universal
 Maletín de transporte



S04H6321S

335.00€

Juego de llaves de vaso de 3/4" con 20 piezas

Composición/ medidas en mm:

- R1206N** Carraca reversible de 500
S04H61 Llaves de vaso: 19; 21; 22; 24; 27; 30; 32; 36; 38; 41; 46 y 50
S24H6 Prolongadores de 100; 200 y 400
S22H6475 Cable articulado 475
S16H3412 Adaptador 3/4"F para 1/2"M
S16H3410 Adaptador 3/4"F para 1"M
S15H6109 Adaptador universal
 Maletín de transporte



S04H4524S

111.00€

Juego de llaves de vaso de 1/2" con 24 piezas

Composición/ medidas en mm:

- R3704** Carraca de 48 dientes
S04H4 Llaves de vaso: 10 a 24; 27; 30 y 32
S24H4 Prolongador de 5" y 10"
S23H41300 Extensión flexible
S15H472 Adaptador universal
S22H41375 Mango flexible 15"
 Maletín en metal



S04H8115S

540.00€

Juego de llaves de vaso de 1" con 14 piezas

Composición/ medidas en mm:

- Carraca
 Llaves de vaso: 36; 41; 46; 50; 55; 60; 65; 70; 75 y 80
 Prolongador de 200 y 400
 Extensión flexible de 550



S04H4728S

125.00€

Juego de llaves de vaso hexagonales de 1/2" con 28 piezas

Composición/ medidas en mm:

- R3704** Carraca de 48 dientes
S04H4 Llaves de vaso: 8 a 28; 30; 32 y 34
S24H4250 Prolongador 10"
S23H41300 Extensión flexible
S15H472 Adaptador universal
 Maletín en metal



S06H425S

53.00€

Juego de 25 puntas torx de 1/2" y 1/4"

Composición/ medidas en mm:

- S07H2** Puntas torx de 1/4": T8; T10; T15; T20; T25; T27 y T30x32
S07H3 Puntas torx de 1/2": T40; T45; T50; T55 y T60x55
S06H2 Llaves de tornillos torx 1/4": E4; E5; E6; E7 y E8
S06H4 Llaves de tornillos torx 1/2": E10; E11; E12; E14 y E18
H08 Llaves macho torx: T6; T8 y T10



S06H4127S

107.00€

Juego de 27 puntas de 1/2" y 3/8"

Composición/ medidas en mm:

S09H4 Puntas allen de 1/2": 4; 5; 6; 7; 8; 10 y 12x55; 14x60; 17x70; 8x80 y 10x140

S49H4 Puntas XZN de 1/2": M5; M6; M8; M10; M12; M14; M16x55; M10; M12x110 y M8x120

S09H3 Puntas allen de 3/8": 4; 5; 6; 7; 8 y 10x48



S07H4109S

32.50€

Juego de 9 llaves puntas torx de 1/2"

Composición:

T20; T25; T27; T30; T40; T50; T55 y T60



S07H4932S

130.00€

Juego de 32 llaves puntas torx de 1/2"

Composición:

Puntas 55mm: T20; T25; T27; T30; T40; T45; T50; T55; T60 y T70

Puntas 100mm: T20; T25; T27; T30; T40; T45; T50; T55; T60 y T70

Puntas 140mm: T40; T45; T50; T55; T60 y T70

Puntas 200mm: T40; T45; T50; T55; T60 y T70

Maletín de transporte



S09H4109S

33.00€

Juego de 9 llaves puntas hexagonales de 1/2"

Composición:

H3; H4; H5; H6; H7; H8; H10; H12 y H14



S63H4132S

125.00€

Juego de 32 llaves puntas ribe (Ribe) 1/2"

Composición:

Puntas 55mm: M5; M6; M7; M8; M9; M10; M12; M13 y M14

Puntas 100mm: M5; M6; M7; M8; M9; M10; M12; M13 y M16

Puntas 140mm: M8; M9; M10; M12; M13 y M14

Puntas 200mm: M8; M9; M10; M12; M13 y M14

Maletín de transporte



S64H4126S
115.00€
Juego de 26 llaves puntas ZNX 1/2"

Composición:

- Puntas 55mm: M5; M6; M8; M10; M12; M14 y M16
- Puntas 100mm: M5; M6; M8; M10; M12 y M14
- Puntas 140mm: M5; M6; M8; M10; M12 y M14
- Puntas 200mm: M8; M10; M12 y M14
- Maletín de transporte

S04H52477S
205.00€
Juego de 77 piezas de herramienta de 1/2" y 1/4"

Composición/ medidas en mm:

- R2904 Carraca 1/2" reversible de 36 dientes
- R2902 Carraca 1/4" reversible de 36 dientes
- S04H4 Llaves de vaso 1/2": 12 a 32
- S04H21 Llaves de vaso 1/4": 4 a 12
- S04HD21 Llaves de vaso largas 1/4": 8; 10; 12 y 13
- S17H Llaves de bujías 1/2": 16 y 21mm
- W26 Llaves fija/ estrella: 8; 10; 12; 13; 14; 15; 17 y 19
- D04 Juego de destornilladores planos
- S24H Prolongadores 1/2" de 125 y 250
- S24H275 Prolongadores 1/4" con 75
- S15H472 Adaptador universal 1/2"
- S15H240 Adaptador universal 1/4"
- S16H304 Adaptador 3/8"F para 1/2"M
- S23H21130 Extensión flexible 1/4"
- P2810 Alicata ajustable
- P088 Alicata universal
- M09500 Martillo mecánico 500g
- Maletín de transporte

S04H52460S
164.00€
Juego de 60 piezas de herramienta de 1/2" y 1/4"

Composición/ medidas en mm:

- Carraca 1/2" de 36 dientes
- Llaves de vaso 1/2": 12; 13; 14; 15; 17; 18; 19; 22 y 24
- Llaves de vaso 1/4": 6; 8; 9; 10; 11; 12 y 13
- Llaves de bujías 1/2": 16 y 21
- Llaves mixtas: 8; 10; 12; 13; 14 y 17
- Juego de destornilladores planos/ phillips
- Puntas de 1/4": planas, torx y phillips
- Porta puntas de 1/4"
- Prolongadores 1/2" de 125 y 250
- Prolongador 1/4" con 75
- Extensión flexible de 1/4"
- Adaptador 3/8"F para 1/2"M
- Extensión flexible 1/4"
- Alicata ajustable
- Alicata universal
- Puntas de 1/4"
- Martillo
- Cardán de 1/2"
- Mango de 1/4"

S04H52478S
268.00€
Juego de 78 piezas de herramienta de 1/2" y 1/4"

Composición/ medidas en mm:

- Carraca 1/2" de 48 dientes
- Carraca 1/4" de 48 dientes
- Llaves de vaso 1/4": 5 a 11
- Llaves de vaso largas 1/4": 5 a 12
- Llaves de bujías 1/2": 16 y 21
- Llaves de vaso 1/2": 12 a 19; 22; 24; 27 y 32
- Llaves mixtas: 6 a 17; 19; 21; 22 y 24
- Llaves allen hexagonales: 2,5 a 10
- Llaves allen torx: T10; T15; T20; T25; T27; T30 y T40
- Llaves estrella abierta: 8x10; 11x13; 12x14 y 17x19
- Juego de destornilladores planos/ phillips
- Prolongadores 1/2" de 125 y 250
- Prolongador 1/4" con 50
- Adaptador 3/8"F para 1/2"M
- Extensión flexible 1/4"
- Alicata de presión
- Cardán de 1/2" y 1/4"
- Mango de 1/4"



S04H524127S

450.00€

Juego de 127 piezas de herramienta de 1/2" y 1/4"

Composición/ medidas en mm:

- R2904 Carraca 1/2" reversible de 36 dientes
- R2902 Carraca 1/4" reversible de 36 dientes
- Llaves de vaso 1/2": 8 a 11; 13 a 19; 21; 22; 24; 27; 30 y 32
- Llaves de vaso 1/4": 4; 4,5; 5; 5,5; 6 a 13
- Llaves de vaso larga 1/2": 10; 12; 13; 14; 15; 17 y 19
- Llaves de vaso larga 1/4": 7; 8; 10; 12 y 13
- Llaves de bujías 1/2": 16 y 21
- Llaves de vaso torx 1/4": E4; E5; E6; E7 y E8
- Llaves torx 1/2": E10; E12; E14; E16; E18; E20; E22 y E24
- Llaves mixtas: 6 a 17; 19; 21; 22; 24; 27; 30 y 32
- Llaves estrella abierta: 8x10; 9x11; 12x13; 14x17 y 17x19
- Llaves hexagonales cortas: 1,5; 2; 2,5; 3; 4; 5; 6; 8 y 10
- Llaves torx: T10; T15; T20; T25; T27; T30 y T40
- H08M Destornilladores planos con mango antideslizante
- D71S Destornilladores phillips con mango antideslizante
- D71P Destornilladores phillips con mango antideslizante
- Juego de botadores y cortafrios
- S21H Prolongadores 1/4" de 50x150 y de 1/2" 50mm
- S24H Prolongadores 1/2" de 125 y 250 y de 1/4" de 75
- Extensor flexible 1/4" de 145
- Extensión flexible 1/4" de 130 y 1/2" de 250
- Extensión flexible 1/2" de 375
- P2810 Alicata ajustable
- P8606 Alicata de corte
- P8007 Alicata universal
- AG010034 Imán
- M09500 Martillo mecánico 500g
- Cardán de 1/2" y 1/4"
- Maletín de transporte



S04H624101S

282.00€

Juego de 101 piezas de herramienta de 1/2" y 1/4"

Composición/ medidas en mm:

- R2904 Carraca 1/2" reversible de 36 dientes
- R2902 Carraca 1/4" reversible de 36 dientes
- S04H4 Llaves de vaso allen 1/2": 8 a 24; 27; 30 y 32
- S04H2 Llaves de vaso allen 1/4": 4; 4,5; 5; 5,5; 6; 7; 8; 9 y 10
- S17H4 Llaves de bujías 1/2": 16 y 21
- S06H4 Llaves de vaso torx 1/2": E11; E12; E14; E16 y E18
- W24 Llaves estrella abierta: 8x10; 11x13; 12x14 y 17x19
- W26 Llaves fija/ estrella: 8; 10 a 19; 21; 22 y 24
- D04 Juego destornilladores planos
- S24H4 Prolongadores 1/2" de 125 y 250
- S21H4 Prolongador 1/2" de 50
- S24H2 Prolongadores 1/4" de 75 y 100
- S27H4 Extensión flexible 1/4"
- S14H4 Adaptador universal 1/2"
- S15H2 Adaptador universal 1/4"
- S23H2 Extensión flexible 1/4"
- S23H4 Extensión flexible 1/2"
- W27AS8 Alicata ajustable
- P087 Alicata universal
- AG010034 Imán
- Puntas de 1/4"
- Puntas ZXN - M6; M8; M10 y M12
- Maletín de transporte

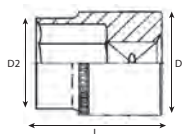

S04H21
Llave de vaso de 6 caras 1/4"

Ref.	Medida (mm)	D1 (mm)	D2 (mm)	L (mm)	Precio
S04H2104	4	11,8	6,8	25	0.80€
S04H21045	4,5	11,8	7,3	25	0.80€
S04H2105	5	11,8	8	25	0.80€
S04H21055	5,5	11,8	8,6	25	0.85€
S04H2106	6	11,8	9,2	25	0.85€
S04H2107	7	11,8	10,5	25	0.85€
S04H2108	8	11,4	11,7	25	0.90€
S04H2109	9	11,6	12,7	25	0.95€
S04H2110	10	12,8	13,7	25	0.95€
S04H2111	11	14,4	15,7	25	1.00€
S04H2112	12	13,7	16,6	25	1.00€
S04H2113	13	13,9	17,6	25	1.10€
S04H2114	14	17,5	20	25	1.15€

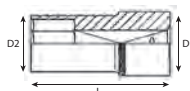
S04HD21
Llave de vaso de 6 caras larga 1/4"

Ref.	Medida (mm)	D1 (mm)	D2 (mm)	L (mm)	Precio
S04HD2105	5	11,8	8,1	50	1.40€
S04HD2106	6	12	9,2	50	1.40€
S04HD2107	7	12	10,5	50	1.40€
S04HD2108	8	11,5	12	50	1.40€
S04HD2109	9	11,3	13,2	50	1.50€
S04HD2110	10	13,3	14,4	50	1.50€
S04HD2111	11	14,8	15,9	50	1.60€
S04HD2112	12	15,8	17	50	1.70€
S04HD2113	13	16,8	17,8	50	1.80€

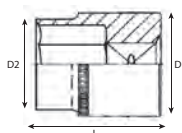
S04H31
Llave de vaso de 6 caras 3/8"

Ref.	Medida (mm)	D1 (mm)	D2 (mm)	L (mm)	Precio
S04H3106	6	16,8	9,6	28	1.10€
S04H3107	7	16,8	10,7	28	1.10€
S04H3108	8	16,8	12	28	1.10€
S04H3109	9	16,8	13,3	28	1.15€
S04H3110	10	16,8	14,4	28	1.15€
S04H3111	11	16,8	15,8	28	1.15€
S04H3112	12	16	16,8	28	1.20€
S04H3113	13	18	19	28	1.20€
S04H3114	14	18,8	19,7	28	1.20€
S04H3115	15	19,8	20,8	28	1.20€
S04H3116	16	20,8	22	28	1.25€
S04H3117	17	22	23,8	28	1.45€
S04H3118	18	24,1	25,7	28	1.55€
S04H3119	19	24,1	25,7	28	1.60€
S04H3120	20	25	27,6	32	1.75€
S04H3121	21	25	27,6	32	1.85€
S04H3122	22	27,8	29,6	32	2.00€
S04H3124	24	29,8	31	32	2.15€



S04HD31

Llave de vaso de 6 caras larga 3/8"

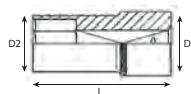

Ref.	Medida (mm)	D1 (mm)	D2 (mm)	L (mm)	Precio
S04HD3109	9	16,8	13,3	63	2.10€
S04HD3110	10	17	14,4	63	2.10€
S04HD3111	11	17	15,8	63	2.20€
S04HD3112	12	17	17,7	63	2.30€
S04HD3113	13	18	19	63	2.30€
S04HD3114	14	18,8	19,7	63	2.30€
S04HD3110	10	17	14,4	63	2.40€
S04HD3116	16	20,8	22	63	2.40€
S04HD3117	17	22,8	23,8	63	2.70€
S04HD3119	19	23,8	26	63	2.90€
S04HD3120	20	24,8	27,8	63	3.20€
S04HD3121	21	25,8	28	63	3.20€
S04HD3124	24	28	24	63	3.60€

S04H41

Llave de vaso de 6 caras 1/2"

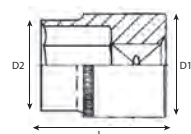

Ref.	Medida (mm)	D1 (mm)	D2 (mm)	L (mm)	Precio
S04H4108	8	21,8	13,8	38	1.45€
S04H4109	9	21,8	14,3	38	1.45€
S04H4110	10	21,8	15,4	38	1.50€
S04H4111	11	21,8	16,7	38	1.50€
S04H4112	12	21,8	18	38	1.50€
S04H4113	13	21,8	19	38	1.55€
S04H4114	14	22	20,3	38	1.55€
S04H4115	15	22	21,3	38	1.55€
S04H4116	16	22	23,3	38	1.65€
S04H4117	17	23	23,8	38	1.70€
S04H4118	18	23,5	24,8	38	1.85€
S04H4119	19	24	27	38	1.85€
S04H4120	20	24	28	38	2.15€
S04H4121	21	24	29	38	2.20€
S04H4122	22	28	30	38	2.50€
S04H4123	23	28	30,7	38	2.65€
S04H4124	24	28	31,8	38	2.75€
S04H4125	25	28	33,8	38	3.15€
S04H4126	26	30	34	42	3.35€
S04H4127	27	28	35,7	42	3.35€
S04H4128	28	30	38	42	3.40€
S04H4129	29	32	38	42	4.10€
S04H4130	30	34	39,8	42	4.10€
S04H4132	32	36	42	42	4.20€
S04H4134	34	40	45	48	5.80€
S04H4136	36	41	48	48	7.30€



S04HD41

Llave de vaso de 6 caras larga 1/2"



Ref.	Medida (mm)	D1 (mm)	D2 (mm)	L (mm)	Precio
S04HD4109	12	21,8	12,7	76	3.30€
S04HD4110	10	21,8	15,4	76	3.40€
S04HD4111	11	21,8	16,7	76	3.40€
S04HD4112	12	21,8	18	76	3.50€
S04HD4113	13	21,8	19	76	3.50€
S04HD4114	14	22	20,3	76	3.60€
S04HD4115	15	22	21,3	76	3.70€
S04HD4116	16	22	23	76	3.70€
S04HD4117	17	23	23,8	76	3.80€
S04HD4118	18	23	24,8	76	3.90€
S04HD4119	19	24	25,8	76	4.00€
S04HD4120	20	24	28	76	4.10€
S04HD4121	21	24	29	76	4.10€
S04HD4122	22	26	30	76	4.20€
S04HD4123	23	28	31,8	76	4.30€
S04HD4124	24	28	31,8	76	4.30€
S04HD4125	25	28	33,8	76	6.00€
S04HD4126	26	28	33,8	76	6.20€
S04HD4127	27	28	35,7	76	6.40€
S04HD4128	28	30	38	76	7.10€
S04HD4130	30	34	39,8	76	7.50€
S04HD4132	32	36	42	76	8.30€

S04HD4115

45.00€

Juego de 10 llaves de vaso largas de 1/2" - 6 caras

Composición:

S04HD4 Llaves: 10; 11; 13; 14; 15; 17; 19; 21; 22 y 24mm

S04H61

Llave de vaso de 6 caras 3/4"

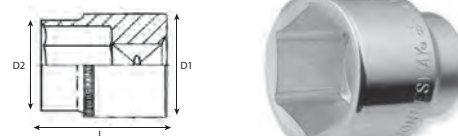

Ref.	Medida (mm)	D1 (mm)	D2 (mm)	L (mm)	Precio
S04H6119	19	30	36	49,5	5.60€
S04H6121	21	32	36	49,5	5.60€
S04H6122	22	33	36	49,5	5.60€
S04H6124	24	35	36	49,5	6.10€
S04H6127	27	38	36	52	6.60€
S04H6128	28	39	36	52	6.60€
S04H6130	30	42	38	54	7.20€
S04H6132	32	44	38	56	7.50€
S04H6134	34	46	38	58	9.30€
S04H6136	36	50	42	58	9.50€
S04H6138	38	52	45	60	10.10€
S04H6141	41	56	45	64	11.10€
S04H6146	46	62	48	68	13.50€
S04H6150	50	68	48	72	14.90€
S04H6152	52	69	48	73	21.00€

S04H63

Llave de vaso 3/4" - 12 caras

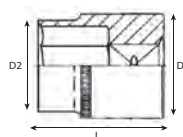

Ref.	Medida (mm)	D1 (mm)	D2 (mm)	L (mm)	Precio
S04H6319	19	30	36	49,5	5.30€
S04H6321	21	32	36	49,5	5.50€
S04H6322	22	33	36	49,5	5.50€
S04H6323	23	34	36	49,5	5.50€
S04H6324	24	35	36	49,5	5.80€
S04H6325	25	37	36	50	6.30€
S04H6326	26	37	36	50	6.40€
S04H6327	27	38	36	52	6.50€
S04H6329	29	40	38	53	6.80€
S04H6330	30	42	38	54	7.30€
S04H6332	32	44	38	56	7.50€
S04H6334	34	46	38	58	9.00€
S04H6336	36	50	42	58	9.60€
S04H6338	38	52	45	60	9.80€
S04H6341	41	56	45	64	11.50€
S04H6346	46	62	48	68	14.00€
S04H6350	50	68	48	72	15.50€
S04H6355	55	74	48	76	19.70€
S04H6356	56	75	48	76	19.90€
S04H6360	60	70	48	78	22.00€
S04H6365	65	87	60	85	34.00€

S04H64

Llave de vaso 3/4" - 12 caras (en pulgadas)

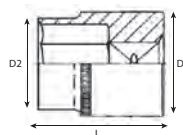

Ref.	Medida	D1 (mm)	D2 (mm)	L (mm)	Precio
S04H6419	3/4"	30	36	49,5	6.50€
S04H6421	13/16"	32	36	49,5	6.50€
S04H6422	7/8"	33	36	49,5	6.50€
S04H6424	15/16"	34	36	49,5	6.50€
S04H6426	1"	35	36	49,5	6.70€
S04H6427	1-1/16"	38	36	52	6.70€
S04H6429	1-1/8"	40	38	53	7.00€
S04H6430	1-3/16"	42	38	54	7.00€
S04H6432	1-1/4"	44	38	56	7.20€
S04H6433	1-5/16"	46	38	56	7.40€
S04H6435	1-3/8"	48	42	58	8.60€
S04H6436	1-7/16"	50	42	58	8.80€
S04H6438	1-1/2"	52	45	60	9.50€
S04H6440	1-9/16"	52	45	60	10.50€
S04H6441	1-5/8"	56	45	64	10.50€
S04H6443	1-11/16"	56	45	64	11.20€
S04H6444	1-3/4"	56	45	64	11.70€
S04H6446	1-13/16"	62	48	68	12.30€
S04H6447	1-7/8"	62	48	68	15.50€
S04H6450	2"	68	48	72	15.70€
S04H6456	2/14"	75	48	76	20.40€



S04H83
Llave de vaso 1" - 12 caras

Ref.	Medida (mm)	D1 (mm)	D2 (mm)	L (mm)	Precio
S04H8355	55	76	57	80	28.00€
S04H8360	60	82	57	84	33.00€
S04H8365	65	88	57	87	37.00€

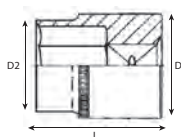
S05H4113S
35.50€
Juego de 13 llaves de vaso de 1/2" - 12 caras

Composición:

S05H4 Llaves: 10; 12; 13; 14; 15; 16; 17; 18; 19; 20; 21; 22 y 24mm

S05H4213S
44.00€
Juego de 13 llaves de vaso de 1/2" SAE

Composición:

Llaves: 3/8"; 7/16"; 1/2"; 9/16"; 5/8"; 11/16"; 3/4"; 13/16"; 7/8"; 15/16"; 1"; 1-1/16" y 1-1/8"

S05HD41
Llave de vaso 6 caras larga 1/2"

Ref.	Medida (mm)	D1 (mm)	D2 (mm)	L (mm)	Precio
S05HD4110	10	21,8	15,4	76	3.50€
S05HD4111	11	21,8	16,7	76	3.50€
S05HD4112	12	21,8	18	76	3.60€
S05HD4113	13	21,8	19	76	3.70€
S05HD4117	17	23,8	23,8	76	3.80€
S05HD4118	18	24,8	16,7	76	4.00€
S05HD4119	19	25,8	25,8	76	4.00€
S05HD4120	20	27,9	27,9	76	4.20€
S05HD4121	21	27,9	27,9	76	4.40€
S05HD4122	22	30	30	76	4.50€
S05HD4123	23	31,8	31,8	76	5.30€
S05HD4124	24	31,8	31,8	76	6.70€
S05HD4127	27	36	36	76	7.70€
S05HD4130	30	40	40	76	7.70€
S05HD4132	32	42	42	76	8.30€

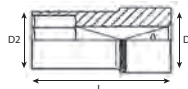
S05HD4113S
65.00€
Juego de 13 llaves de vaso largas 1/2" - 6 caras

Composición:

S05HD4 Llaves: 11; 13; 14; 15; 17; 19; 21; 22; 23; 24; 27; 30 y 32mm

S06H37S

18.00€
Juego de 7 llaves de vaso para tornillos torx 3/8"

Composición:

S06H3 Llaves: E10; E11; E12; E14; E16; E18 y E20

S05HD4213S
53.00€
Juego de 13 llaves de vaso largas 1/2" SAE

Composición:

Llaves: 7/16"; 1/2"; 9/16"; 5/8"; 11/16"; 3/4"; 13/16"; 7/8"; 15/16"; 1"; 1-1/16"; 1-1/8" y 1-1/4"

S06H49S

28.50€
Juego de 9 llaves de vaso para tornillos torx 1/2"

Composición:

S06H4 Llaves: E10; E11; E12; E14; E16; E18; E20; E22 y E24

S66H41

Llave de vaso de 1/2" - 12 caras



Ref.	Medida (mm)	Precio
S66H4108	8	1.35€
S66H4110	10	1.45€
S66H4111	11	1.50€
S66H4112	12	1.50€
S66H4113	13	1.55€
S66H4114	14	1.55€
S66H4115	15	1.55€
S66H4116	16	1.60€
S66H4117	17	1.70€
S66H4118	18	1.85€
S66H4119	19	1.85€
S66H4120	20	2.35€
S66H4121	21	2.35€
S66H4122	22	2.55€
S66H4124	24	3.20€
S66H4125	25	3.65€
S66H4126	26	4.10€
S66H4127	27	4.20€
S66H4128	28	4.30€
S66H4130	30	4.60€
S66H4132	32	5.60€
S66H4136	36	7.70€

S66HD41

Llave de vaso largas de 1/2" - 12 caras



Ref.	Medida (mm)	Precio
S66HD4110	10	2.35€
S66HD4111	11	2.60€
S66HD4112	12	2.60€
S66HD4113	13	2.70€
S66HD4114	14	2.70€
S66HD4115	15	2.70€
S66HD4116	16	2.80€
S66HD4117	17	2.90€
S66HD4118	18	3.20€
S66HD4119	19	3.20€
S66HD4120	20	3.30€
S66HD4121	21	3.50€
S66HD4122	22	4.00€
S66HD4123	23	4.00€
S66HD4124	24	4.20€
S66HD4127	27	5.00€
S66HD4130	30	6.70€
S66HD4132	32	7.30€



PHILLIPS	PLANA	TORX	TORX TEMP.	HEXAGONAL	XZN
----------	-------	------	------------	-----------	-----

S06H2

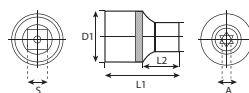
Llave de vaso torx 1/4"

Ref.	Medida	D1 (mm)	D2 (mm)	L1 (mm)	L2 (mm)	Precio
S06H204	E4	12	6,2	25	11	1.20€
S06H205	E5	12	7,2	25	11	1.30€
S06H206	E6	12	8,2	25	11	1.30€
S06H207	E7	12	9	25	11	1.30€
S06H208	E8	12	10,3	25	11	1.30€
S06H210	E10					1.30€
S06H211	E11					1.30€

S06H3

Llave de vaso punta torx 3/8"

Ref.	Medida	L1 (mm)	L2 (mm)	L3 (mm)	Precio
S06H306	E6	17	11,2	28	1.70€
S06H307	E7	17	11,2	28	1.70€
S06H308	E8	17	11,2	28	1.70€
S06H310	E10	17	13,2	28	1.70€
S06H311	E11	17	13,8	28	1.70€
S06H312	E12	17	14,8	28	1.70€
S06H314	E14	18	16,8	28	1.70€
S06H316	E16	20	18,8	28	1.70€
S06H318	E18	22	20,8	28	1.70€
S06H320	E20	24	22,8	28	1.90€

S06H4

Llave de vaso torx 1/2"

Ref.	Medida	D1 (mm)	D2 (mm)	L1 (mm)	L2 (mm)	Precio
S06H410	E10	22	13,2	38	17	2.30€
S06H411	E11	22	13,9	38	17	2.30€
S06H412	E12	22	15	38	17	2.30€
S06H414	E14	22	16,7	38	17	2.40€
S06H416	E16	22	18,8	38	17	2.45€
S06H418	E18	22	20,8	38	17	2.45€
S06H420	E20	22	23	38	17	2.60€
S06H422	E22	22	25	38	17	2.65€
S06H424	E24	22	27	38	17	3.20€



**S07H2**

Llave de vaso punta torx 1/4" - 37mm

Ref.	Medida	L1 (mm)	L2 (mm)	L3 (mm)	L (mm)	D (mm)	d (mm)	Precio
S07H206	T6	13	19	25	37	12	10,8	1.10€
S07H207	T7	13	19	25	37	12	10,8	1.10€
S07H208	T8	13	19	25	37	12	10,8	1.10€
S07H209	T9	13	19	25	37	12	10,8	1.10€
S07H210	T10	13	19	25	37	12	10,8	1.10€
S07H215	T15	13	19	25	37	12	10,8	1.10€
S07H220	T20	13	19	25	37	12	10,8	1.10€
S07H225	T25	13	19	25	37	12	10,8	1.10€
S07H227	T27	13	19	25	37	12	10,8	1.10€
S07H230	T30	13	19	25	37	12	10,8	1.10€
S07H240	T40	13	19	25	37	12	10,8	1.10€

S07H3

Llave de vaso punta torx 3/8" - 48mm

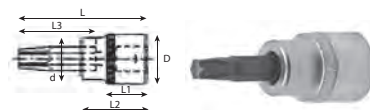

Ref.	Medida	L1 (mm)	L2 (mm)	L3 (mm)	L (mm)	D (mm)	d (mm)	Precio
S07H310	T10	16,5	26	30	48	18	13,8	1.30€
S07H315	T15	16,5	26	30	48	18	13,8	1.30€
S07H320	T20	16,5	26	30	48	18	13,8	1.30€
S07H325	T25	16,5	26	30	48	18	13,8	1.30€
S07H327	T27	16,5	26	30	48	18	13,8	1.30€
S07H330	T30	16,5	26	30	48	18	13,8	1.30€
S07H340	T40	16,5	26	30	48	18	13,8	1.30€
S07H345	T45	16,5	26	30	48	18	15,8	1.50€
S07H350	T50	16,5	26	30	48	18	15,8	1.50€
S07H355	T55	16,5	26	30	48	18	16,1	1.60€
S07H360	T60	16,5	26	30	48	18	16,1	1.80€

S07H4

Llave de vaso punta torx 1/2" - 55mm



Ref.	Medida	L1 (mm)	L2 (mm)	L3 (mm)	L (mm)	D (mm)	d (mm)	Precio
S07H420	T20	20	38	30	55	22	15	2.30€
S07H425	T25	20	38	30	55	22	15	2.30€
S07H427	T27	20	38	30	55	22	15	2.45€
S07H430	T30	20	38	30	55	22	15	2.45€
S07H440	T40	20	38	30	55	22	15	2.45€
S07H445	T45	20	38	30	55	22	15	2.50€
S07H450	T50	20	38	30	55	22	15	2.50€
S07H455	T55	20	38	30	55	22	17	2.50€
S07H460	T60	20	38	30	55	24	22	2.70€
S07H470	T70	20	38	30	55	24	22	2.90€



S07H43

Llave de vaso punta torx 1/2" - 100mm

Ref.	Medida	L1 (mm)	L2 (mm)	L3 (mm)	L (mm)	D (mm)	d (mm)	Precio
S07H4320	T20	20	38	75	100	24	15	3.40€
S07H4325	T25	20	38	75	100	24	15	3.40€
S07H4327	T27	20	38	75	100	24	15	3.40€
S07H4330	T30	20	38	75	100	24	15	3.50€
S07H4340	T40	20	38	75	100	24	15	3.50€
S07H4345	T45	20	38	75	100	24	15	3.50€
S07H4350	T50	20	38	75	100	24	15	3.50€
S07H4352	T52	20	38	75	100	24	15	3.50€
S07H4355	T55	20	38	75	100	24	17	3.50€
S07H4360	T60	20	38	75	100	24	22	3.90€
S07H4370	T70	20	38	75	100	24	22	4.00€

S07H45

Llave de vaso punta torx de 1/2"

Ref.	Medida	Longitud (mm)	Precio
S07H4530	T30	200	5.80€
S07H4540	T40	200	5.80€
S07H4545	T45	200	5.80€

S08H311S

15.00€
Juego de 11 puntas de 1/4" y 3/8" torx tamperproof

Composición:

Llaves de 1/4": T8; T10; T15; T20; T25 y T27

Llaves de 3/8": T30; T40; T45; T50 y T55

S09H2

Llave de vaso punta allen 1/4" - 37mm

Ref.	Medida	L1 (mm)	L2 (mm)	L3 (mm)	L (mm)	D (mm)	d (mm)	Precio
S09H203	H3	13	19	25	37	12	10,8	1.15€
S09H204	H4	13	19	25	37	12	10,8	1.15€
S09H205	H5	13	19	25	37	12	10,8	1.15€
S09H206	H6	13	19	25	37	12	10,8	1.15€
S09H207	H7	13	19	25	37	12	10,8	1.25€

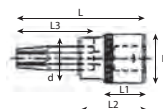
S09H3

Llave de vaso punta allen 3/8" - 48mm

Ref.	Medida	L1 (mm)	L2 (mm)	L3 (mm)	L (mm)	D (mm)	d (mm)	Precio
S09H303	H3	16,5	26	30	48	18	13,8	1.35€
S09H304	H4	16,5	26	30	48	18	13,8	1.35€
S09H305	H5	16,5	26	30	48	18	13,8	1.35€
S09H306	H6	16,5	26	30	48	18	13,8	1.35€
S09H307	H7	16,5	26	30	48	18	15,8	1.35€
S09H308	H8	16,5	26	30	48	18	15,8	1.50€
S09H310	H10	16,5	26	30	48	18	16,1	1.50€
S09H312	H12	16,5	26	30	48	18	16,1	1.70€
S09H314	H14	16,5	26	30	48	18	16,1	1.95€



S09H4



Llave de vaso punta allen 1/2" - 55mm



Ref.	Medida	L1 (mm)	L2 (mm)	L3 (mm)	L (mm)	D (mm)	d (mm)	Precio
S09H404	H4	20	38	30	55	24	15	2.50€
S09H405	H5	20	38	30	55	24	15	2.50€
S09H406	H6	20	38	30	55	24	15	2.50€
S09H407	H7	20	38	30	55	24	15	2.50€
S09H408	H8	20	38	30	55	24	15	2.50€
S09H410	H10	20	38	30	55	24	17,8	2.60€
S09H412	H12	20	38	30	55	24	22	2.90€
S09H414	H14	20	38	30	55	24	22	2.90€
S09H416	H16	20	38	30	55	24	22	3.10€
S09H417	H17	20	38	30	55	24	22	3.75€
S09H419	H19	20	38	30	55	24	22	4.15€

S09H43



Llave de vaso punta allen 1/2" - 100mm



Ref.	Medida	L1 (mm)	L2 (mm)	L3 (mm)	L (mm)	D (mm)	d (mm)	Precio
S09H4304	H4	20	38	75	100	24	15	3.45€
S09H4305	H5	20	38	75	100	24	15	3.45€
S09H4306	H6	20	38	75	100	24	15	3.50€
S09H4307	H7	20	38	75	100	24	15	3.50€
S09H4308	H8	20	38	75	100	24	15	3.50€
S09H4309	H9	20	38	75	100	24	15	3.65€
S09H4310	H10	20	38	75	100	24	20,8	3.65€
S09H4312	H12	20	38	75	100	24	22	3.70€
S09H4314	H14	20	38	75	100	24	22	3.90€
S09H4316	H16	20	38	75	100	24	22	4.65€
S09H4317	H17	20	38	75	100	24	22	5.10€
S09H4319	H19	20	38	75	100	24	22	7.30€

S10H2



Llave de vaso punta plana 1/4" - 37mm

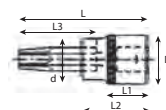

Ref.	Medida (mm)	L1 (mm)	L2 (mm)	L3 (mm)	L (mm)	D (mm)	d (mm)	Precio
S10H230	3	13	21	25	37	12	10,8	1.15€
S10H235	3,5	13	21	25	37	12	10,8	1.15€
S10H240	4	13	21	25	37	12	10,8	1.15€
S10H245	4,5	13	21	25	37	12	10,8	1.15€
S10H250	5	13	21	25	37	12	10,8	1.15€
S10H255	5,5	13	21	25	37	12	10,8	1.15€
S10H260	6	13	21	25	37	12	10,8	1.15€
S10H270	7	13	21	25	37	12	10,8	1.25€



S10H3

Llave de vaso punta plana 3/8" - 48mm

Ref.	Medida (mm)	L1 (mm)	L2 (mm)	L3 (mm)	L (mm)	D (mm)	d (mm)	Precio
S10H340	4	15,5	26,5	30	48	18	13,8	1.20€
S10H350	5	15,5	26,5	30	48	18	13,8	1.20€
S10H355	5,5	15,5	26,5	30	48	18	13,8	1.25€
S10H360	6	15,5	26,5	30	48	18	13,8	1.25€
S10H370	7	15,5	26,5	30	48	18	13,8	1.25€
S10H380	8	15,5	26,5	30	48	18	15,8	1.25€
S10H3100	10	15,5	26,5	30	48	20	17,8	1.45€
S10H3120	12	15,5	26,5	30	48	20	17,8	1.75€

S10H4

Llave de vaso punta plana 1/2" - 55mm

Ref.	Medida (mm)	L1 (mm)	L2 (mm)	L3 (mm)	L (mm)	D (mm)	d (mm)	Precio
S10H480	8	20	36	30	55	22	17,8	2.40€
S10H490	9	20	36	30	55	22	17,8	2.60€
S10H4100	10	20	36	30	55	22	17,8	2.65€
S10H4110	11	20	36	30	55	24	20,8	2.75€
S10H4120	12	20	36	30	55	24	20,8	2.75€

S11H2

Llave de vaso punta phillips 1/4" - 37mm

Ref.	Medida	L1 (mm)	L2 (mm)	L3 (mm)	L (mm)	D (mm)	d (mm)	Precio
S11H200	PH0	13	19	25	37	12	10,8	1.15€
S11H201	PH1	13	19	25	37	12	10,8	1.15€
S11H202	PH2	13	19	25	37	12	10,8	1.15€
S11H203	PH3	13	19	25	37	12	10,8	1.15€

S11H3

Llave de vaso punta phillips 3/8" - 48mm

Ref.	Medida	L1 (mm)	L2 (mm)	L3 (mm)	L (mm)	D (mm)	d (mm)	Precio
S11H300	PH0	16,5	26	30	48	18	13,8	1.25€
S11H301	PH1	16,5	26	30	48	18	13,8	1.25€
S11H302	PH2	16,5	26	30	48	18	13,8	1.25€
S11H303	PH3	16,5	26	30	48	18	15,8	1.25€
S11H304	PH4	16,5	26	30	48	18	15,8	1.45€

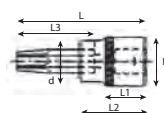
S11H4

Llave de vaso punta phillips 1/2" - 55mm

Ref.	Medida	L1 (mm)	L2 (mm)	L3 (mm)	L (mm)	D (mm)	d (mm)	Precio
S11H402	PH2	55	38	30	55	24	15	2.40€
S11H403	PH3	55	38	30	55	24	15	2.40€
S11H404	PH4	55	38	30	55	24	15	2.40€



S49H4



Llave de vaso puntas XZN de 1/2"

Ref.	Medida	Longitud (mm)	Precio
S49H4105	M5	55	3.10€
S49H4106	M6	55	3.20€
S49H4108	M8	55	3.20€
S49H4110	M10	55	3.20€
S49H4112	M12	55	3.30€
S49H4114	M14	55	3.90€
S49H4116	M16	55	5.40€
S49H4308	M8	100	4.50€
S49H4310	M10	100	4.80€
S49H4312	M12	100	4.90€
S49H4314	M14	100	6.00€
S49H4318	M18	100	8.80€



S50H3106S



13.00€

Juego de 6 puntas allen 3/8"

Composición:

Llaves: 4; 5; 6; 7; 8 y 10 mm



S50H3206S



12.60€

Juego de 6 puntas allen 3/8" SAE

Composición:

Llaves: 5/32"; 3/16"; 7/32"; 1/4"; 5/16" y 3/8"



S54H5509S



15.00€

Juego de 9 llaves de torx de 1/4" y 3/8"

Composición:

S54H2 Llaves de 1/4": T10; T15; T20 y T25

S54H3 Llaves de 3/8": T25; T30; T40; T45 y T50



S63H33

Llave de vaso Ribe 3/8" - 90mm

Ref.	Medida	Longitud (mm)	Precio
S63H3306	M6	90	1.70€
S63H3307	M7	90	2.00€
S63H3308	M8	90	2.00€
S63H3310	M10	90	2.65€



S63H43

Llave de vaso Ribe 1/2" - 100mm

Ref.	Medida	Longitud (mm)	Precio
S63H4306	M6	100	3.30€
S63H4307	M7	100	3.40€
S63H4308	M8	100	3.50€
S63H4310	M10	100	3.70€
S63H4312	M12	100	3.90€
S63H4313	M13	100	4.00€



S63H44

Llave de vaso Ribe 1/2" - 55mm

Ref.	Medida	Longitud (mm)	Precio
S63H4405	M5	55	2.60€
S63H4406	M6	55	2.70€
S63H4407	M7	55	2.70€
S63H4408	M8	55	2.75€
S63H4409	M9	55	2.95€
S63H4410	M10	55	3.10€
S63H4412	M12	55	3.50€
S63H4413	M13	55	4.10€
S63H4414	M14	55	4.80€



S63H4507S

23.50€

Juego de 7 puntas largas allen (Ribe) 3/8" y 1/2"

Composición:

Puntas 3/8" de 90 mm: M6; M7; M8 y M10

Puntas 1/2" de 100 mm: M12; M13 y M14



S63H46

Llave de vaso Ribe 1/2" - 100mm

Ref.	Medida	Longitud (mm)	Precio
S63H4605	M5	100	3.30€
S63H4606	M6	100	3.40€
S63H4607	M7	100	3.40€
S63H4608	M8	100	3.50€
S63H4609	M9	100	3.60€
S63H4610	M10	100	3.60€
S63H4612	M12	100	4.10€
S63H4613	M13	100	5.20€
S63H4614	M14	100	5.50€



S63H47

Llave de vaso Ribe 1/2" - 140mm

Ref.	Medida	Longitud (mm)	Precio
S63H4708	M8	140	4.10€
S63H4709	M9	140	4.10€
S63H4710	M10	140	4.10€
S63H4712	M12	140	5.20€
S63H4713	M13	140	6.00€
S63H4714	M14	140	6.00€

S63H48

Llave de vaso Ribe 1/2" - 200mm

Ref.	Medida	Longitud (mm)	Precio
S63H4808	M8	200	4.80€
S63H4809	M9	200	4.90€
S63H4810	M10	200	5.00€
S63H4812	M12	200	6.20€
S63H4813	M13	200	7.30€
S63H4814	M14	200	7.40€

C-DMH

Barra magnética para llaves de vaso

Ref.	Medida	Capacid. (llaves)	Precio
C-DMH212	1/4"	12	16.00€
C-DMH314	3/8"	14	25.00€
C-DMH414	1/2"	12	26.00€

MSH

Tira de soporte para llaves de vaso

Ref.	Medida	Capacid. (llaves)	Precio
MSH1214	1/2"	14	2.30€
MSH1414	1/4"	14	1.90€
MSH3814	3/8"	14	2.10€

S15H

Cardán

Ref.	Medida	D1 (mm)	D2 (mm)	L (mm)	Acabado	Precio
S15H240	1/4"	14	14	35	Mate	2.60€
S15H356	3/8"	18	18	49	Mate	3.90€
S15H472	1/2"	25	25	69	Mate	5.00€
S15H6109	3/4"	39,7	39,5	106,2	Pulido	25.00€

S64H4

Llave de vaso puntas XZN de 1/2"

Ref.	Medida	Longitud (mm)	Precio
S64H4104	M4	55	2.80€
S64H4105	M5	55	2.80€
S64H4106	M6	55	2.80€
S64H4107	M7	55	2.80€
S64H4109	M9	55	2.80€
S64H4112	M12	55	3.40€
S64H4113	M13	55	4.10€
S64H4114	M14	55	4.30€
S64H4204	M4	100	3.30€
S64H4205	M5	100	3.30€
S64H4206	M6	100	3.40€
S64H4207	M7	100	3.40€
S64H4208	M8	100	3.50€
S64H4209	M9	100	3.50€
S64H4210	M10	100	3.60€
S64H4212	M12	100	4.20€
S64H4214	M14	100	5.30€
S64H4216	M16	100	6.10€
S64H4218	M18	100	10.30€
S64H4705	M5	140	3.90€
S64H4706	M6	140	3.90€
S64H4708	M8	140	4.20€
S64H4709	M9	140	4.20€
S64H4710	M10	140	4.20€
S64H4712	M12	140	5.00€
S64H4714	M14	140	6.00€
S64H4808	M8	200	4.80€
S64H4810	M10	200	4.80€
S64H4812	M12	200	6.10€
S64H4814	M14	200	7.00€



S16H

Adaptador

Ref.	Medida	A (mm)	D1 (mm)	D2 (mm)	L (mm)	Acabado	Precio
S16H1234	1/2" F - 3/4" M	19	12,7	27	45	Pulido	4.40€
S16H1238	1/2" F - 3/8" M	9,52	12,7	22	34	Mate	1.45€
S16H1438	1/4" F - 3/8" M	9,52	6,35	14	25	Mate	1.15€
S16H3410	3/4" F - 1" M	25,3	19,05	39,7	59,6	Pulido	11.20€
S16H3412	3/4" F - 1/2" M	12,7	19,05	35	51	Pulido	6.80€
S16H3812	3/8" F - 1/2" M	12,7	9,52	17	35	Mate	1.35€
S16H3814	3/8" F - 1/4" M	6,35	9,75	18,6	28	Mate	1.10€



S16H

Adaptador

Ref.	Medida	A (mm)	D1 (mm)	D2 (mm)	L (mm)	Acabado	Precio
S16H302	1/4" M - 3/8" F	6,35	9,75	18,6	28	Mate	2.15€
S16H304	1/2" M - 3/8" F	12,7	9,75	23,5	43,7	Mate	3.20€
S16H403	3/8" M - 1/2" F	9,5	12,9	23,5	40	Mate	3.15€



S17H

Llave de bujías

Ref.	Medida	A (mm)	D1 (mm)	D2 (mm)	L (mm)	Acabado	Precio
S17H3116	3/8"	9,525	21,7	18,8	65	Mate	1.70€
S17H3121	3/8"	9,525	27,6	21,5	65	Mate	2.30€
S17H4116	1/2"	12,7	21,8	21,8	65	Mate	1.65€
S17H4121	1/2"	12,7	27,6	23,6	65	Mate	2.30€

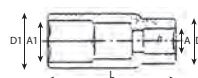

S17H3414

6.00€

Llave de bujías 12 caras 3/8"

Medida: 14mm



S21H

Prolongador

Ref.	Cuadradillo	Medida (mm)	Acabado	Precio
S21H4150	1/2"	50	Mate	3.30€
S21H4175	1/2"	75	Mate	3.90€
S21H41125	1/2"	125	Mate	4.70€
S21H41250	1/2"	250	Mate	7.00€



S22H

Mango articulado

Ref.	Cuadradillo	Medida (mm)	Acabado	Precio
S22H21130	1/4"	130	Mate	5.70€
S22H31200	3/8"	200	Mate	7.90€
S22H41375	1/2"	375	Mate	15.50€
S22H41450	1/2"	450	Mate	19.50€



S22H

Mango articulado

Ref.	Cuadradillo	Medida (mm)	Acabado	Precio
S22H41600	1/2"	600	Pulido	24.70€
S22H6500	3/4"	500	Pulido	39.00€



S22H41600RK

9.80€

Kit de reparación para mango articulado S22H41600



S22H6500RK

15.50€

Kit de reparación para mango articulado S22H6500



S22H21130RK

2.70€

Kit de reparación para mango articulado S22H21130



S22H41375RK

3.20€

Kit de reparación para mango articulado S22H41375 y S22H41450



S23H

Extensión flexible

Ref.	Cuadradillo	Medida (mm)	Acabado	Precio
S23H21115	1/4"	115	Mate	2.10€
S23H31200	3/8"	200	Mate	4.60€
S23H41250	1/2"	250	Mate	6.10€
S23H41300	1/2"	300	Mate	6.80€
S23H6450	3/4"	450	Pulido	22.50€
S23H6500	3/4"	500	Pulido	24.50€
S23H8550	1"	550	Pulido	46.00€

S24H

Prolongadores

Ref.	Cuadradillo	Medida (mm)	Acabado	Precio
S24H250	1/4"	50	Mate	1.20€
S24H375	3/8"	75	Mate	1.80€
S24H450	1/2"	50	Mate	2.50€
S24H475	1/2"	75	Mate	3.00€
S24H2100	1/4"	100	Mate	1.35€
S24H2150	1/4"	150	Mate	1.55€
S24H3150	3/8"	150	Mate	2.50€
S24H3200	3/8"	200	Mate	2.80€
S24H3250	3/8"	250	Mate	3.65€
S24H4125	1/2"	125	Mate	3.70€
S24H4224	1/2"	610	Pulido	22.50€
S24H4250	1/2"	250	Mate	4.60€
S24H6100	3/4"	100	Pulido	10.30€
S24H6200	3/4"	200	Pulido	13.80€
S24H6400	3/4"	400	Pulido	24.30€
S24H8200	1"	200	Pulido	27.00€

S26H2150
2.70€
Mango de 1/4"

S26H2280
13.00€
Mango 1/4" doble función fijado/ cardán

AG010184F
5.80€
Llave flexible punta macho de 1/4"

AG0101

Llave de mango flexible con vaso

Ref.	Cuadradillo	Medida (mm)	Precio
AG010184B		6	6.50€
AG010184C		7	6.50€
AG010184D		8	6.50€
AG010184E		10	6.50€

S27H

Prolongadores flexibles

Ref.	Cuadradillo	Medida (mm)	Precio
S27H2	1/4"	145	2.50€
S27H3	3/8"	193	18.50€
S27H4	1/4"	205	18.00€

S40H

Llaves en T de punta flexible

Ref.	Medida (mm)	Longitud (mm)	Long.Puño (mm)	Precio
S40H108	8	300	200	10.00€
S40H110	10	300	200	10.00€
S40H112	12	300	200	10.00€
S40H114	14	300	200	10.00€

S40T

Llaves en T de punta flexible

Ref.	Medida (mm)	Precio
S40T108	8	22.00€
S40T110	10	22.00€
S40T112	12	22.00€
S40T113	13	22.00€
S40T114	14	22.00€
S40T117	17	22.00€
S40T119	19	22.00€

S40T109S
142.00€
Juego de 9 piezas "T" flexibles

 Composición/ medidas en mm:
 8; 10; 12; 13; 14; 17 y 19
 Guiones P/T

S41H41
11.50€
Manivela cuadradillo macho de 1/2"

S42M

Prolongadores magnéticos



Ref.	Cuadradillo	Medida (mm)	Precio
S42M475	1/2"	75	9.20€
S42M4125	1/2"	125	9.20€
S42M4250	1/2"	250	13.00€

S42M403S

31.00€

Juego de 3 prolongadores magnéticos 1/2"

Composición/ medidas en mm:
75; 125 y 250



S44H2206

1.00€

Porta puntas 1/4"

Cuadradillo de 1/4" para uso en puntas de la broca de 1/4"



S44H3110A

2.60€

Porta puntas

Cuadradillo: 3/8"

Utilización en puntas: 3/8"



S44H3206

2.10€

Porta puntas

Cuadradillo: 3/8"

Utilización en puntas: 1/4"



S44H4110

1.90€

Porta puntas

Cuadradillo: 1/2"

Utilización en puntas: 3/8"



S60H4304S

40.00€

Juego de 4 prolongadores de 1/2"

Composición/ medidas en mm:
75; 125; 250 y 375



R53A-3

Adaptador "macho/macho"

Para aplicación en combinación con el cable flexible T de R53A

Precio

Ref.	Cuadradillo	Longitud (mm)	Precio
R53A-2A	1/4"	20	1.10€
R53A-3A	3/8"	30	1.60€
R53A-4A	1/2"	35	2.10€



R19H3

Llaves pie de gallo 3/8"

Ref.	Medida (mm)	Precio
R19H3110	10	4.90€
R19H3111	11	4.90€
R19H3112	12	4.90€
R19H3113	13	4.90€
R19H3114	14	4.90€
R19H3115	15	4.90€
R19H3116	16	5.10€
R19H3117	17	5.20€
R19H3118	18	5.30€
R19H3119	19	5.40€



R19H310S

45.00€

Juego de 10 llaves pie de gallo de 3/8"

Composición/ medidas en mm:

Llaves: 10; 11; 12; 13; 14; 15; 16; 17; 18 y 19



S03A4111S

39.00€

Juego de 11 llaves de impacto de 1/2"

Composición/ medidas (mm):

S03A4 Llaves: 10; 11; 12; 13; 14; 16; 17; 19; 21; 22 y 24



S01U41
Cardan de impacto 1/2"

Ref.	Medida (mm)	Longitud (mm)	Precio
S01U4113	13	70	11.80€
S01U4114	14	70	11.90€
S01U4115	15	70	11.90€
S01U4116	16	70	11.90€
S01U4117	17	70	11.90€
S01U4119	19	70	12.80€
S01U4121	21	70	13.40€
S01U4122	22	70	14.00€

S01U4108S
103.00€
Juego 8 llaves/ cardáns impacto 1/2"

Composición/ medidas em mm:

 Llaves: 13; 14; 15; 16;
17; 19; 21 y 22

S03A2
Llave de impacto 1/4"

Ref.	Cuadradillo	Medida (mm)	Precio
S03A2110	1/4"	10	1.55€
S03A2112	1/4"	12	1.65€
S03A2114	1/4"	14	1.80€

S03AD4111S
61.00€
Juego de 11 llaves de impacto largas de 1/2"

Composición/ medidas (mm):

S03AD4 Llaves: 10; 11; 12; 13; 14; 16; 17; 19; 21; 22 y 24

S03A4A
Adaptador de 1/2"

Ref.	Cuadradillo	Precio
S03A4A3	3/8"	4.20€
S03A4A6	3/4"	5.80€

S03A4U4
10.80€
Cardán de 1/2"

S03A4UT3S
33.00€
Juego de 3 cardáns impacto

Composición/ medidas:

1/4"; 3/8" y 1/2"

S03A
Cardan de impacto

Ref.	Cuadradillo	Precio
S03A2UT	1/4"	8.40€
S03A3UT	3/8"	10.30€
S03A4UT	1/2"	13.50€

S03A4E
Prolongador

Ref.	Cuadradillo	Medida (mm)	Precio
S03A4E4	1/2"	100	5.30€
S03A4E5	1/2"	125	5.60€
S03A4E6	1/2"	150	6.90€
S03A4E8	1/2"	200	7.70€

S03A4211S
40.30€
Juego de 11 llaves impacto 1/2" SAE

Composición:

Ref.	Medida	Ref.	Medida
S03A4210	3/8"	S03AD4219	3/4"
S03A4211	7/16"	S03AD4221	13/16"
S03A4213	1/2"	S03AD4222	7/8"
S03A4214	9/16"	S03AD4224	15/16"
S03A4216	5/8"	S03AD4226	1"
S03A4217	11/16"		



S03AD4414S
97.00€
Juego de 14 llaves largas impacto 1/2" SAE

Composición/ medidas:

 Llaves: 3/8"; 7/16"; 1/2"; 9/16"; 5/8"; 11/16"; 3/4";
13/16"; 7/8"; 15/16"; 1"; 1-1/16"; 1-1/8" y 1-1/4"

S03A4

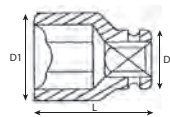
Llave impacto 1/2"



Ref.	Medida (mm)	D1 (mm)	D2 (mm)	L (mm)	Precio
S03A4109	9	15	24	38	2.80€
S03A4110	10	17	24	38	2.80€
S03A4111	11	19	24	38	2.90€
S03A4112	12	20	24	38	2.90€
S03A4113	13	20,8	24	38	2.95€
S03A4114	14	22	24	38	2.95€
S03A4115	15	24	24	38	3.00€
S03A4116	16	24	24	38	3.25€
S03A4117	17	26	26	38	3.35€
S03A4118	18	26	27	38	3.45€
S03A4119	19	28	28	38	3.60€
S03A4120	20				3.70€
S03A4121	21	30	30	38	3.80€
S03A4122	22	32	30	38	4.00€
S03A4123	23	34	30	38	4.30€
S03A4124	24	34	30	43	4.60€
S03A4127	27	38	30	43	6.50€
S03A4129	29	40	30	48	7.40€
S03A4130	30	42	30	48	7.60€
S03A4132	32	44,6	30	48	8.00€

S03AD4

Llave impacto larga 1/2"

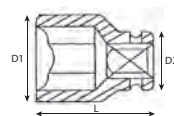

Ref.	Medida (mm)	D1 (mm)	D2 (mm)	L (mm)	Precio
S03AD4110	10	17	24	78	4.80€
S03AD4111	11	19	24	78	4.80€
S03AD4112	12	19,6	24	78	4.80€
S03AD4113	13	20,8	24	78	4.80€
S03AD4114	14	22	24	78	4.80€
S03AD4115	15	24	24	78	4.85€
S03AD4116	16	24	24	78	4.90€
S03AD4117	17	26	26	78	5.20€
S03AD4118	18	28	27	78	5.50€
S03AD4119	19	28	28	78	5.60€
S03AD4120	20	30	30	78	5.70€
S03AD4121	21	30	30	78	6.20€
S03AD4122	22	32	30	78	6.50€
S03AD4123	23	33,3	30	78	6.80€
S03AD4124	24	34,6	30	78	7.20€
S03AD4125	25	35,8	30	78	8.00€
S03AD4126	26	37	30	78	9.00€
S03AD4127	27	38	30	78	9.10€
S03AD4128	28	39,5	30	78	9.80€
S03AD4130	30	42	30	78	11.00€
S03AD4132	32	44,6	30	78	11.50€

S03A6
Llave impacto 3/4"

Ref.	Medida (mm)	D1 (mm)	D2 (mm)	L (mm)	Precio
S03A6126	26	41	38	51	7.20€
S03A6127	27	43	40	53	7.50€
S03A6129	29	45	42	53	7.90€
S03A6130	30	46	44	53	8.60€
S03A6132	32	49	44	57	9.30€
S03A6133	33	51	44	57	9.70€
S03A6134	34	51	44	57	10.10€
S03A6135	35	53	44	57	10.50€
S03A6136	36	54	44	57	11.40€
S03A6137	37	55	44	57	11.90€
S03A6138	38	56	44	57	12.10€
S03A6139	39	57,7	44	57	13.10€
S03A6140	40	59	44	57	14.30€
S03A6141	41	60	44	57	15.00€
S03A6142	42	61,4	44	57	17.10€
S03A6143	43	62,7	44	62	17.80€
S03A6144	44	64	44	62	19.00€
S03A6145	45	65	44	62	19.60€
S03A6146	46	66,4	44	62	19.80€
S03A6147	47	67,6	44	67	20.70€
S03A6148	48	68,8	44	67	21.00€
S03A6149	49	70	44	72	22.50€
S03A6150	50	71,4	72	72	24.00€
S03A6151	51	72,8	72	72	28.00€
S03A6152	52	74	72	72	29.00€
S03A6153	53	75	72	72	29.50€
S03A6154	54	76,4	72	72	30.00€
S03A6155	55	77,7	74	74	32.50€
S03A6156	56	79	74	74	34.50€
S03A6157	57	80	74	74	35.50€
S03A6158	58	81,5	75	75	38.00€
S03A6159	59	82,7	75	75	40.00€
S03A6160	60	84	75	75	42.50€
S03A6163	63	87,6	75	75	45.50€
S03A6165	65	90	78	78	48.00€
S03A6167	67	92,7	80	80	55.00€
S03A6170	70	96,4	83	83	57.00€

S03A6108S
82.00€
Juego de 8 llaves de impacto de 3/4"

Composición/ medidas:

S03A6 Llaves: 26; 27; 29; 30; 32; 35; 36 y 38

S03AD6

Llave impacto larga 3/4"

Ref.	Medida (mm)	D1 (mm)	D2 (mm)	L (mm)	Precio
S03AD6124	24	38,9	44	90	16.00€
S03AD6126	26	41,3	44	90	16.50€
S03AD6127	27	42,6	44	90	17.00€
S03AD6129	29	45,1	44	90	17.00€
S03AD6130	30	46,4	44	90	17.00€
S03AD6132	32	48,9	44	90	17.50€
S03AD6133	33	50,6	44	90	18.00€
S03AD6134	34	51,4	44	90	18.00€
S03AD6135	35	52,7	44	90	18.50€
S03AD6136	36	53,9	44	90	20.00€
S03AD6138	38	56,4	44	90	21.50€
S03AD6140	40	58,9	44	90	24.50€
S03AD6141	41	60,1	44	90	25.00€
S03AD6142	42	61,4	44	90	28.50€
S03AD6144	44				30.50€
S03AD6146	46	66,4	44	90	32.50€
S03AD6150	50	71,4	54	90	38.00€



S03AD6107S

125.00€

Juego de 7 llaves de impacto largas de 3/4"

Composición/ medidas:

S03AD6 Llaves: 26; 27; 29;
32; 35; 36 y 38



S03AD6120S

265.00€

Juego de 20 piezas de impacto de 3/4"

Composición/ medidas en mm:

S03AD6 Llaves: 24; 27; 30; 32; 33; 34; 35; 36; 41 y 46
 S03A4A6 Adaptador 1/2" - 3/4"
 S03A8A6 Adaptador 1" - 3/4"
 S03A6U6 Cardán 3/4"
 S03A6E Extensor de 3/4" 250 mm
 Pernos
 Anillos de goma



S03A6A

Adaptador de 3/4"

Ref.	Cuadradillo	Precio
S03A6A4	1/2"	11.20€
S03A6A8	1"	13.50€



S03A6U6

36.00€

Cardán de 3/4"



S03A6E

Prolongador

Ref.	Cuadradillo	Medida (mm)	Precio
S03A6E04	3/4"	100	18.50€
S03A6E08	3/4"	200	22.00€
S03A6E10	3/4"	250	26.00€

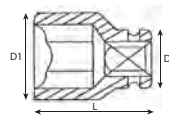

S03A8
Llave impacto 1"

Ref.	Medida (mm)	D1 (mm)	D2 (mm)	L (mm)	Precio
S03A8124	24	41,9	54	58	18.00€
S03A8127	27	45,6	54	58	18.50€
S03A8129	29	48,1	54	60	18.50€
S03A8130	30	49,4	54	60	18.50€
S03A8132	32	51,9	54	60	19.00€
S03A8133	33	53,6	54	60	19.00€
S03A8134	34	54,4	54	62	19.50€
S03A8135	35	55,7	54	62	20.00€
S03A8136	36	56,9	54	62	23.00€
S03A8138	38	59,4	54	65	23.00€
S03A8140	40	110	54	65	23.00€
S03A8141	41	63,1	54	65	24.00€
S03A8144	44	120	54	65	26.00€
S03A8146	46	69,4	54	74	27.00€
S03A8150	50	74,4	54	74	33.00€
S03A8155	55	80,7	54	85	40.00€
S03A8160	60	87,1	54	90	52.00€
S03A8165	65	93,2	54	90	62.00€
S03A8170	70	99,4	54	100	78.00€
S03A8173	73	103,3	86	100	91.00€
S03A8175	75	105,6	86	100	99.00€
S03A8176	76	106,9	86	100	115.00€
S03A8178	78	110	86	100	120.00€
S03A8180	80	111,9	86	100	125.00€
S03A8185	85	118,5	86	110	155.00€
S03A8189	89	123,2	86	110	157.00€
S03A8190	90	124,4	86	110	180.00€
S03A8192	92	126,8	86	110	185.00€
S03A8195	95	129	86	110	205.00€

S03A8109S
210.00€
Juego de 9 llaves impacto 1"

Composición/ medidas:

S03A8 Llaves: 24; 27; 30; 32; 35; 38; 41; 46 y 50

S03A8A6
18.50€
Adaptador 1" - 3/4"

S03A8E
Prolongador impacto

Ref.	Cuadradillo	Medida (mm)	Precio
S03A8E04	1"	100	28.00€
S03A8E07	1"	175	34.00€
S03A8E10	1"	250	52.00€

S03AD8107S
186.00€
Juego de 7 llaves largas de impacto 1"

Composición/ medidas:

S03AD8 Llaves: H5, H6, H8, H10, H12, H14, H17 y H19
Maletín en metal

S03AD8

Llave impacto larga 1"



Ref.	Medida (mm)	D1 (mm)	D2 (mm)	L (mm)	Precio
S03AD8117	17	33,1	54	90	24.00€
S03AD8124	24	41,9	54	90	25.00€
S03AD8126	26	43,3	54	90	25.00€
S03AD8127	27	45,6	54	90	25.00€
S03AD8129	29	48,1	54	90	26.00€
S03AD8130	30	49,4	54	90	26.50€
S03AD8132	32	51,9	54	90	27.00€
S03AD8133	33	53,6	54	90	27.00€
S03AD8134	34	54,4	54	90	27.50€
S03AD8135	35	55,7	54	90	28.00€
S03AD8136	36	56,9	54	90	28.50€
S03AD8138	38	59,4	54	90	29.50€
S03AD8140	40	61,9	54	90	30.50€
S03AD8141	41	63,1	54	90	31.50€
S03AD8142	42	64,4	54	90	32.50€
S03AD8146	46	69,4	54	90	36.00€
S03AD8148	48	71,8	54	90	41.00€
S03AD8150	50	74,4	54	90	49.00€
S03AD8155	55	80,7	54	90	60.50€
S03AD8158	58	84,5	54	105	64.50€
S03AD8160	60	87,1	54	120	74.50€
S03AD8165	65	93,2	54	120	84.00€



S03S8

Llave de impacto



Ref.	Cuadradillo	Medida (mm)	Precio
S03S8117	1"	17	18.00€
S03S8119	1"	19	18.50€
S03S8121	1"	21	18.50€

S03SD8

Llave de impacto



Ref.	Cuadradillo	Medida (mm)	Precio
S03SD8117	1"	17	23.00€
S03SD8119	1"	19	24.00€
S03SD8121	1"	21	25.50€

S05A4H

Punta allen de impacto 1/2"

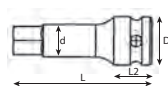

Ref.	Medida	D (mm)	d (mm)	L2 (mm)	L (mm)	Precio
S05A4H4	H4	25	6	22,5	78	7.90€
S05A4H5	H5	25	7	22,5	78	8.00€
S05A4H6	H6	25	8	22,5	78	8.10€
S05A4H7	H7	25	9	22,5	78	8.10€
S05A4H8	H8	25	10,5	22,5	78	8.15€
S05A4H10	H10	25	12,5	22,5	78	8.60€
S05A4H12	H12	25	15	22,5	78	8.60€
S05A4H14	H14	25	17,5	22,5	78	8.60€
S05A4H17	H17	25	21	22,5	78	8.60€
S05A4H18	H18	25	22	22,5	78	8.60€
S05A4H19	H19	25	23	22,5	78	8.65€

S05A408S

55.00€

Juego de 8 llaves de vaso con punta macho hexagonal de impacto 1/2"

Composición:

S05A4 Llaves: H5; H6; H8; h10; H12; H14; H17 y H19

S05A6105S

90.00€

Juego de 5 puntas hexagonales de impacto 3/4"

Composición:

S05A6 Llaves: 14; 17; 19; 22 y 24mm de 88mm

S05A6H

Llave de impacto hexagonal de 3/4"

Ref.	Medida (mm)	Longitud (mm)	Precio
			15.50€
S05A6H14	14	88	15.50€
S05A6H17	17	88	15.50€
S05A6H19	19	88	15.50€
S05A6H22	22	88	15.50€
S05A6H24	24	88	15.50€

S06A4T

Llaves de vaso con punta macho torx de impacto de 1/2"

Ref.	Medida	Precio
S06A4T20	T20	8.30€
S06A4T27	T27	8.30€
S06A4T30	T30	8.30€
S06A4T40	T40	8.30€
S06A4T45	T45	8.30€
S06A4T50	T50	8.30€
S06A4T55	T55	8.30€
S06A4T60	T60	8.30€
S06A4T70	T70	8.60€
S06A4T80	T80	8.60€

S06A408S

50.00€

Juego de 8 llaves vaso con punta macho torx de impacto 1/2"

Composición:

S06A4 Llaves: T30; T40; T45; T50; T55; T60; T70 y T80

S64A4106S

41.50€

Juego de 6 llaves de impacto XZN de 1/2"

Composición:

S064A4 3 Llaves: M14; M16 y M18 de 45mm
 3 Llaves: M14; M16 y M18 de 76mm

S64A61

Llave de impacto perfil XZN de 3/4"

Ref.	Medida	Longitud (mm)	Precio
S64A6116	M16	61	12.00€
S64A6118	M18	61	12.30€

S64A6306S

71.00€

Juego de 6 llaves de impacto XZN y Torx de 3/4"

Composición:

S064A6 4 Llaves Torx: T70; T80; T90 y T100 de 61mm
 2 Llaves XZN: M16 y M18 de 61mm

S64A6T

Llave de impacto perfil Torx de 3/4"

Ref.	Medida	Longitud (mm)	Precio
S64A6T70	T70	61	11.50€
S64A6T80	T80	61	11.70€
S64A6T90	T90	61	12.30€
S64A6T100	T100	61	12.80€

S12A4525S

220.00€

Juego de 25 llaves impacto magnéticas de 1/2"

Composición:

 Llaves de 1/2": 3/8"; 7/16"; 1/2"; 9/16"; 5/8"; 11/16";
 3/4"; 13/16"; 7/8"; 15/16" y 1"
 Llaves de 1/2": 10 a 21mm
 Cardán de 1/2"
 Prolongador 80mm

S18A4117M 21.00€

Llave impacto magnética de 17 mm de 1/2"

S18A4119M 17.00€

Llave impacto magnética de 19 mm de 1/2"

S18A4121M 17.00€

Llave impacto magnética de 21 mm de 1/2"

S18A4103MS 65.00€

Juego de 3 llaves impacto magnéticas de 1/2"

Composición:

Llaves: 17; 19 y 21mm

S18A41

Llave impacto larga para ruedas



Ref.	Cuadradillo	Medida (mm)	D (mm)	L (mm)	Color	Precio
S18A4115	1/2"	15	25	85	Naranja	7.00€
S18A4117	1/2"	17	27	85	Azul	9.60€
S18A4119	1/2"	19	28,5	85	Verde	10.00€
S18A4121	1/2"	21	31	85	Rojo	10.50€

S18AD41

Llave impacto extra larga para ruedas



Ref.	Cuadradillo	Medida (mm)	D (mm)	L (mm)	Color	Precio
S18AD4117	1/2"	17	27	150	Azul	18.00€
S18AD4119	1/2"	19	28,5	150	Verde	18.00€
S18AD4121	1/2"	21	31	150	Rojo	18.00€

S03AD4317 8.50€

Llave impacto de 17 mm de 1/2"

S03AD4319 8.50€

Llave impacto de 19 mm de 1/2"

S03AD4321 8.50€

Llave impacto de 21 mm de 1/2"

S03AD4303S 29.00€

Juego de 3 llaves impacto de 1/2"

Composición:

Ref.	Medida (mm)
S03AD4317	17
S03AD4319	19
S03AD4321	21

S03AD4307S 76.50€

Juego de 7 llaves impacto de 1/2"

Composición:

Ref.	Medida (mm)	Ref.	Medida (mm)
S03AD4317	17	S03AD4323	23
S03AD4319	19	S03AD4324	24
S03AD4321	21	S03AD4327	27
S03AD4322	22		

S03AD4503S 64.50€

Juego de 3 llaves impacto larga de 1/2"

Composición:

Ref.	Medida (mm)	Longitud (mm)
S03AD4517	17	150
S03AD4519	19	150
S03AD4521	21	150



S03AD4517

18.50€

Llave impacto larga de 17 mm de 1/2"



S03AD4519

18.80€

Llave impacto larga de 19 mm de 1/2"



S03AD4521

19.00€

Llave impacto larga de 21 mm de 1/2"



S46TE80

15.00€

Barra de presión 110Nm de 1/2"

Longitud: 196mm

Color: azul



Alicates

con mango

P018 18.00€

Alicate universal
Longitud: 200mm



P038 14.50€

Alicate de corte diagonal
Longitud: 200mm



P046 12.20€

Alicate de corte
Longitud: 160mm



P068 14.40€

Alicate de puntas
Longitud: 200mm
Capacidad máxima: Ø3,0mm



P068A 13.00€

Alicate de puntas
Longitud: 200mm



P079 19.00€

Alicate universal
Longitud: 220mm
Capacidad máxima: Ø3,0mm



P6008 9.20€

Alicate regulable (2 posiciones)
Longitud: 200mm



P61

Alicate de corte frontal

Ref.	Longitud (mm)	Precio
P6106	160	11.20€
P6108	200	12.50€



P9506 15.90€

Alicate cortafrios
Longitud: 165mm
Peso: 188g



P27

Alicate ajustable

Ref.	Longitud (mm)	Precio
P2706	160	11.00€
P2710	250	14.50€
P2712	330	25.50€



P2810 16.80€

Alicate ajustable
Longitud: 250mm



P266 10.50€

Alicate de frenos internos y externos (puntas intercambiables)
Capacidad: frenos de 12 a 50mm
Puntas de: Ø1,2 y 1,5mm
Puntas rectas de: 45 y de 90°



AG010002S 49.00€

Juego de 4 alicates de freno

Composición:
AG010002 Alicate de freno interior con puntas rectas
AG010005 Alicate de freno interior con puntas curvas
AG010008 Alicate de freno exterior con puntas rectas
AG0100011 Alicate de freno exterior con puntas curvas



AG01000

Alicate de clips interiores (puntas rectas)

Ref.	Longitud (mm)	Precio
AG010002	175	10.50€
AG010003	230	15.50€



AG01000

Alicate de clips interiores (puntas curvas)

Ref.	Longitud (mm)	Precio
AG010005	175	10.70€
AG010006	230	15.50€



AG01000

Alicate de clips exteriores (puntas rectas)

Ref.	Longitud (mm)	Precio
AG010008	175	10.70€
AG010009	230	15.00€



AG01000

Alicate de clips exteriores (puntas curvas 90°)

Ref.	Longitud (mm)	Precio
AG010011	175	10.70€
AG010012	230	15.50€



P9508C

Alicate de frenos para interiores (puntas curvas)

Longitud: 216mm
Capacidad: 10-32mm

19.00€

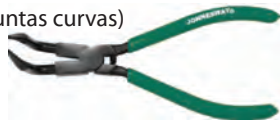

P9508D

Alicate de frenos para exteriores (puntas curvas)

Longitud: 216mm
Capacidad: 10-32mm

19.00€



P9902S

Juego de 2 pinzas de frenos

Composición:

P9920A Alicata con bloque para circlip interna

P9920C Alicata con bloque para circlip externa

Capacidad: 165-300mm

260.00€



P7101

Mini alicate de puntas curvas 45° (diseño ergonómico)

Longitud: 140mm
Peso: 90g

19.60€



P7102

Mini alicate de corte frontal (diseño ergonómico)

Longitud: 110mm
Peso: 90g

18.50€



Alicates

con mango

P7103

Mini alicate de corte diagonal (diseño ergonómico)

Longitud: 115mm
Peso: 90g

16.40€



P7104

Mini alicate universal (diseño ergonómico)

Longitud: 120mm
Peso: 90g

17.00€



P7105

Mini alicate de puntas rectas (diseño ergonómico)

Longitud: 135mm
Peso: 90g

17.00€



P8006

Alicate universal

Longitud: 160mm

19.50€



P8106

Alicate puntas largas

Longitud: 160mm

18.10€



P8606

Alicate de corte diagonal

Longitud: 160mm

18.80€



P9006

Alicate puntas planas

Longitud: 160mm

19.30€



Alicates

con mango

Símbolo				
Tipo de material	Suave	Dureza média	Duro	Cuerda de piano
Ejemplo	Cobre, aluminio	Hierro	Acero	Acero duro/ resorte
Tensión N/mm ²	220-250	750-800	1700-1800	2200-2300

P051

Alicate corta cables

Ref.	Longitud (mm)	Precio
P0516	160	16.80€
P0518	200	19.30€



P0118





Alicate universal

Ref.	Longitud (mm)					Precio
P0118	200	5.0	3.5	2.4	2.0	18.00€



P081





Alicate universal

Ref.	Longitud (mm)					Precio
P0816	160					13.50€
P0817	180					14.70€
P0818	200					17.50€



P091





Alicate de corte (trabajo intenso)

Ref.	Longitud (mm)					Precio
P0916	160	4.0	3.0	2.0	1.6	15.50€
P0917	180	5.0	3.5	2.4	2.0	16.80€
P0918	200	5.0	3.5	2.4	2.0	18.00€



P101





Alicate de corte

Ref.	Longitud (mm)					Precio
P1016	160					14.00€
P1017	180					15.60€



P111





Alicate de puntas

Ref.	Longitud (mm)					Precio
P1116	160					13.00€
P1118	200					15.50€



P121

Alicate de puntas curvas

Ref.	Longitud (mm)					Precio
P1216	160					14.00€
P1218	200					16.80€



P1416

Alicate de puntas planas

Longitud: 160mm

13.70€



P1516

Alicate de pelar

Longitud: 160mm

13.70€



P4016

Alicate de puntas redondas

Longitud: 160mm

13.90€



P6116

Alicate de corte frontal

Ref.	Longitud (mm)					Precio
P6116	160	4.0	3.0	2.0	1.6	15.00€



P2811

Alicate ajustable

Ref.	Longitud (mm)	Precio
P28110	240	20.50€
P28112	300	29.00€



P2821
Alicate ajustable

Ref.	Longitud (mm)	Precio
P28210	240	26.00€
P28212	300	36.00€

P08104S
79.00€
Juego de 4 alicates

Composición:

- P0817 Alicates universales
- P0917 Alicates de corte diagonal
- P1118 Alicates de puntas rectas
- P28210 Alicates de ajustable

PESD05
11.00€
Alicates anti-estático puntas curvas (con muelle)

Longitud: 150mm

PESD10
10.30€
Alicates anti-estático de corte (con muelle)

Longitud: 115mm

PESD11
10.50€
Alicates anti-estático de puntas (con muelle)

Longitud: 130mm

P178
15.00€
Tenazas de carpintero

Longitud: 200mm

P1810
15.30€
Tenazas de encofrado

Longitud: 250mm

Alicates
con mango
P2010LA
12.80€
Tijera articulada

Corte izquierda

Longitud: 250mm

Peso: 395g

Capacidad de corte: Acero: 1,2mm | Acero inoxidable: 0,7mm

P2010RA
13.30€
Tijera articulada

Corte derecha

Longitud: 250mm

Peso: 395g

Capacidad de corte: Acero: 1,2mm | Acero inoxidable: 0,7mm

P2010SA
13.30€
Tijera articulada

Hojas rectas

Longitud: 200mm

P22
Tijera de cortar chapa

Ref.	Longitud (mm)	Precio
P2208A	205	13.50€
P2212A	305	20.50€

P2205E
13.50€
Tijera de electricista

P15808
14.50€
Tijera multifunciones

Laminas en acero inoxidable de 3 mm

Longitud: 206mm

P43
Alicates corta cables

Ref.	Longitud (mm)	Peso	Capac. de corte	Precio
P4318	450	1 570g	hilo 5mm cable 10mm	43.00€
P4330	750	4 200g	hilo 9mm cable 14mm	82.00€



Alicates

P4318-RK 20.00€

Kit de reparación

P4330-RK 40.50€

Kit de reparación

P6424 42.30€

Alicate corta cables

Longitud: 600mm

Peso: 2 700g

Capacidad de corte: Ø 10mm



P7601 21.50€

Alicate largo de puntas rectas

Longitud: 275mm



P7602 21.50€

Alicate largo de puntas curvas 45°

Longitud: 275mm



P7603 21.50€

Alicate largo de puntas curvas 90°

Longitud: 275mm



P7608 22.00€

Alicate largo de puntas redondas Ø13mm

Longitud: 275mm



P7719 36.50€

Alicate largo de torcer alambre

Longitud: 270mm

Peso: 360g

Capacidad: Ø 0,55mm



V1001 18.00€

Alicate de remachar (trabajo intensivo)

Incluye 4 cuadradillos: 2,4; 3,2; 4 y 4,8mm



V1002 59.00€

Alicate de remachar extensible

Incluye 4 cuadradillos: 2,4; 3,2; 4 y 4,8mm



V1002-RK 2.10€

Kit de reparación de alicate de remachar extensible V1002



V1003 47.00€

Remachadora (trabajo intensivo)

Incluye cuadradillos: 6,4; 3,2; 4 y 4,8mm



V1003-RK 4.80€

Kit de reparación de alicate de remachar V1003



V1005 21.00€

Remachadora (cuadradillos intercambiables)

Incluye cuadradillos: 2,4; 3,2; 4 y 4,8mm



V21

Remachadora (cuadradillos intercambiables)

Ref. Cuadradillos (mm) Precio

V2101 2,4; 3,2; 4 y 4,8 mm 32.50€

V2102 3,2; 4; 4,8 y 6,4 mm 47.50€



V2102-RK 5.20€

Kit de reparación de alicate de remachar V2102



V1103 39.50€

Alicate de remaches hembra

Capacidad: M3; M4; M5 y M6



V2401 66.50€

Alicate de remaches hembra

Capacidad: M5; M6; M8 y M10



V2401
Mandril

Ref.	Medida	Precio
V2401-M5A	M5	3.40€
V2401-M6A	M6	3.40€
V2401-M8A	M8	3.40€
V2401-M10A	M10	3.40€



V2401
Boquilla

Ref.	Medida	Precio
V2401-M5B	M5	3.60€
V2401-M6B	M6	3.60€
V2401-M8B	M8	3.60€
V2401-M10B	M10	3.60€

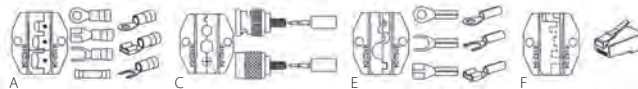

AR030058
118.00€
Alicate de apriete de terminales
 Intercambiable para 6 tipos de terminales

V1311
Alicate de engatillar terminales

Ref.	Características	Precio
V1310A	Terminales aislados	42.50€
V1311C	Clavijas de los cables coaxiales	46.50€
V1311E	Terminales no aislados	42.00€
V1310F	Clavijas RJ45	44.00€

V1310
Accesorios para alicate engatillar terminales V1310

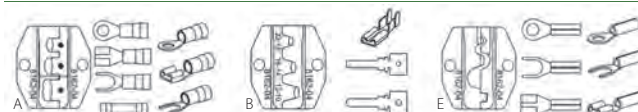
Ref.		Precio
V1310A-11	Mordazas	14.50€
V1310B-11	Mordazas	14.50€
V1310E-11	Mordazas	15.00€
V1310F-11	Mordazas	RJ45 20.20€
V1310G-11	Mordazas	AWG 22-10 (0,5-10mm ²) 20.20€
V1310J-11	Mordazas	AWG 10-60 (6-16mm ²) 20.20€

Alicates
V1401
10.10€
Alicate de engatillar terminales/pelar hilos

V1403
18.00€
Alicate de engatillar (trabajo intensivo)

V1501
24.50€
Alicate de pelar (trabajo intensivo)

Tornillo de ajuste para alambres gruesos

Longitud: 172mm

Peso: 305g

V1505
19.00€
Alicate de pelar

P30M10A
13.80€
Alicate de bloqueo puntas rectas

Longitud: 250mm

Peso: 540g

P32M
Alicate de bloqueo puntas curvas

Ref.	Longitud (mm)	Precio
P32M07A	180	11.80€
P32M10A	250	13.00€

P36M09A
11.60€
Alicate de bloqueo puntas largas

Longitud: 230mm

P36M
Alicate de presión tipo pistola

Ref.	Longitud (mm)	Precio
P36M01P	28	27.50€
P36M02P	48	27.50€



P37M

Alicate de bloqueo cuello de cisne

Ref.	Longitud (mm)	Precio
P37M11A	280	22.10€
P37M18A	450	39.00€



P38M

Alicate de bloqueo para soldadura

Ref.	Longitud (mm)	Precio
P38M09A	230	19.00€
P38M11A	280	23.50€



P52A10

Alicate de presión boca derecha ajustable

Longitud: 250mm

42.00€



P52B10

Alicate de presión boca curva ajustable

Longitud: 250mm

37.00€



P52C10

Alicate de presión boca curva ajustable

Longitud: 250mm

47.00€



P52D12

Alicate de presión boca larga ajustable

Longitud: 300mm

44.00€



P52M10

Alicate de bloqueo puntas curvas

Longitud: 250mm

17.00€



P53M

Alicate cuello de cisne mandibula oscilante

Ref.	Longitud (mm)	Precio
P53M06	152	14.30€
P53M11	280	24.20€
P53M18	460	37.00€



P54M

Alicate de bloqueo para chapista

Ref.	Longitud (mm)	Precio
P54M08A	205	16.00€
P54M10A	250	19.70€



P52N10

Alicate de bloqueo boca larga

Longitud: 240mm

22.00€



P1019

Alicate de bloqueo con cadena

Longitud: 230mm

Capacidad: 457mm

19.00€



P9409

Alicate de bloqueo

Longitud: 175mm

Peso: 360g

16.70€



P30M07C

Alicate de bloqueo con mango

Longitud: 175mm

Peso: 360g

14.20€



P32M

Alicate de bloqueo con mango, puntas curvas y corta cables

Ref.	Longitud (mm)	Peso (g)	Precio
P32M05C	125	175	12.30€
P32M10C	250	560	15.50€





P36M

Alicate de bloqueo con mango, puntas largas y corta cables

Ref.	Longitud (mm)	Peso (g)	Precio
P36M06C	152	180	12.50€
P36M09C	270	560	14.80€

P78M10C

17.30€

Alicate de bloqueo con mango

Longitud: 250mm



P32M03S

44.50€

Juego de 3 alicates de bloqueo

Ref.	Caraterísticas	Longitud (mm)
P36M06S	Cuadrillos largas	160
P32M07S	Cuadrillos cóncavas	180
P32M10S	Cuadrillos cóncavas	250



Alicates

P7801

28.00€

Alicate de bloqueo multifunción

Garras tipo W



P7802

28.00€

Alicate de bloqueo multifunción

Garras tipo JJ



P7803

28.00€

Alicate de bloqueo multifunción

Garras tipo LL



P7804

27.00€

Alicate de bloqueo multifunción

Garras tipo J



P7805

27.00€

Alicate de bloqueo multifunción



D70S

Destornillador plano de impacto

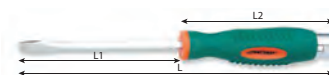

Ref.	Medida (mm)	L1 (mm)	L2 (mm)	L (mm)	Precio
D70S475	4	75	107	182	3.70€
D70S5100	5,5	100	107	207	4.80€
D70S6125	6,5	125	127	252	6.00€
D70S6150	6,5	150	127	277	6.30€
D70S8150	8	150	144	294	7.90€
D70S8175	8	175	144	319	8.00€
D70S9175	9,5	175	144	319	9.00€
D70S9250	9,5	250	144	394	9.80€

D70P

Destornillador phillips de impacto

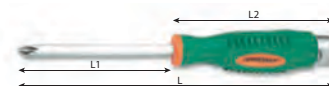

Ref.	Medida	L1 (mm)	L2 (mm)	L (mm)	Precio
D70P175	PH1	75	107	182	4.60€
D70P2100	PH2	100	127	277	5.50€
D70P3125	PH3	125	144	269	8.00€
D70P3150	PH3	150	144	299	8.30€

D70PP07S

48.00€

Juego de 7 destornilladores planos/ phillips de impacto

Composición/ medidas (mm):

3 Destornillador plano impacto: 5,5x100; 6,5x125 y 8x150

3 Destornillador phillips: PH1x75; PH2x100 y PH3x125

1 Destornillador extensible con punta magnética

D70PP10S

68.00€

Juego de 10 destornilladores planos/ phillips de impacto

Composición/ medidas (mm):

D70S Destornillador plano: 5,5x100; 6,5x125; 8x150; 9,5x175 y 6,5x38

D70P Destornillador phillips: PH1x75; PH2x100; PH3x125 y PH2x38

Puntero magnético



DV14PP-TP

3.50€

Buscapolos

220 - 250 v

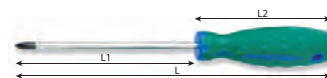

D71P
Destornillador phillips

Ref.	Medida	L1 (mm)	L2 (mm)	L (mm)	Precio
D71P060	PH0	60	90	150	2.70€
D71P138	PH1	38	56	94	2.60€
D71P180	PH1	80	110	190	3.00€
D71P238	PH2	38	56	94	2.60€
D71P1100	PH1	100	110	210	3.20€
D71P1150	PH1	150	110	250	3.50€
D71P1300	PH1	300	110	410	4.70€
D71P2100	PH2	100	119	219	3.60€
D71P2150	PH2	150	119	269	3.90€
D71P2250	PH2	250	119	369	6.00€
D71P2400	PH2	400	119	519	7.00€
D71P3150	PH3	150	129	279	5.40€
D71P3250	PH3	250	129	279	7.10€
D71P3400	PH3	400	129	529	9.20€
D71P4200	PH4	200	129	329	6.40€

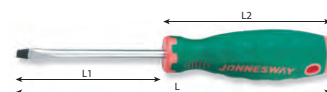
D71S
Destornillador plano

Ref.	Medida (mm)	L1 (mm)	L2 (mm)	L (mm)	Precio
D71S250	2,4	50	72	122	2.30€
D71S360	3	60	72	132	2.50€
D71S4100	4	100	90	190	2.70€
D71S4150	4	150	110	260	3.40€
D71S4200	4	200	90	290	3.80€
D71S480	4	80	90	170	2.60€
D71S5125	5,5	125	110	235	3.10€
D71S5200	5,5	200	110	310	3.50€
D71S5300	5,5	300	110	410	4.70€
D71S538	5,5	38	56	94	2.50€
D71S575	5,5	75	110	185	3.00€
D71S638	6,5	38	56	94	2.50€
D71S6100	6,5	100	119	219	3.70€
D71S6150	6,5	150	119	269	3.80€
D71S6400	6,5	400	119	519	7.50€
D71S8150	8	150	129	279	5.20€
D71S8200	8	200	129	329	5.50€
D71S8300	8	300	129	429	7.40€
D71S8500	8	500	129	629	10.40€
D71S9175	9,5	175	129	304	5.70€
D71S10250	10	250			6.50€

D71T
Destornillador torx

Ref.	Medida	L1 (mm)	L2 (mm)	L (mm)	Precio
D71T5	T5	60	73	132	2.30€
D71T6	T6	60	73	132	2.30€
D71T7	T7	60	73	132	2.30€
D71T8	T8	60	73	132	2.40€
D71T9	T9	60	73	132	2.40€
D71T10	T10	80	90	170	2.50€
D71T15	T15	80	90	170	2.50€
D71T20	T20	100	110	210	3.00€
D71T25	T25	100	110	210	3.00€
D71T27	T27	100	119	219	4.00€
D71T30	T30	125	119	244	4.20€
D71T40	T40	150	129	279	5.30€
D71T45	T45	200	129	329	5.70€
D71T50	T50	200	129	329	6.30€

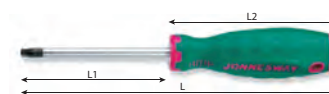
D71400T
Destornillador torx largo

Ref.	Medida	Longitud (mm)	Precio
D71400T10	T10	400	6.20€
D71400T15	T15	400	6.70€
D71400T20	T20	400	7.30€
D71400T25	T25	400	7.80€
D71400T27	T27	400	8.60€
D71400T30	T30	400	9.40€

D71Z
Destornillador pozi

Ref.	Medida	L1 (mm)	L2 (mm)	L (mm)	Precio
D71Z060	PZ0	60	90	150	2.60€
D71Z138	PZ1	38	56	94	2.60€
D71Z180	PZ1	80	110	190	2.90€
D71Z2100	PZ2	100	119	219	3.70€
D71Z3150	PZ3	150	129	279	5.20€
D71Z4200	PZ4	200	129	329	6.50€

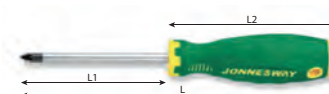
D725N
Llaves T con mango antideslizante con vaso hexagonal

Ref.	Medida (mm)	Longitud (mm)	Precio
D725N06	6	298	6.20€
D725N07	7	298	6.20€
D725N08	8	298	6.20€
D725N09	9	298	6.30€
D725N10	10	298	6.30€
D725N11	11	298	6.40€
D725N12	12	298	6.60€
D725N13	13	298	6.60€



D715N

Llave de vaso con mango



Ref.	Medida	L1 (mm)	L2 (mm)	L (mm)	Precio
D715N05	5	125	119	244	5.30€
D715N07	7	125	119	244	5.40€
D715N08	8	125	119	244	5.40€
D715N10	10	125	119	244	6.00€
D715N12	12	125	119	244	6.00€
D715N13	13	125	119	244	6.40€

D71C105S

18.00€

Juego de 5 destornilladores planos/ phillips

Composición/ medidas (mm):

D71S Destornilladores planos: 4x80; 5,5x125 y 6,5x150

D71P Destornilladores phillips: PH1x80 y PH2x100

D71C106S

20.50€

Juego de 6 destornilladores planos/ phillips

Composición/ medidas (mm):

Destornilladores planos: 3x60; 5,5x125 y 6,5x150

Destornilladores phillips: PH0x60; PH1x80 y PH2x100

D71PP08S

35.50€

Juego de 8 destornilladores planos/ phillips con mango antideslizante

Composición/ medidas (mm):

D71S Destornilladores plano: 6,5x38; 4x80; 5,5x125 y 6,5x150

D71P Destornilladores phillips: PH2x38; PH1x80; PH2x100 y PH3x150

D71PP16S

77.50€

Juego de 16 destornilladores planos/ phillips con mango antideslizante

Composición/ medidas (mm):

D71S Destornilladores planos: 6,5x38; 3x50; 6,5x100;

5,5x125; 5,5x200; 8,5x150; 5,5x75 y 4x150

D71P Destornilladores phillips: PH2x38; PH1x150; PH0x60; PH1x80; PH2x100; PH2x150; PH3x150 y PH1x38

D71T107S

27.00€

Juego de 7 destornilladores torx con mango antideslizante

Composición/ medidas (mm):

Destornilladores: T10; T15; T20; T25; T27; T30 y T40

D71T109S

33.00€

Juego de 9 destornilladores torx con mango antideslizante

Composición/ medidas (mm):

Destornilladores: T8; T9; T10; T15; T20; T25; T27; T30 y T40

D71Z105S

17.00€

Juego de 5 destornilladores planos/ pozi

Composición/ medidas (mm):

Destornilladores plano: 4x80; 5,5x125 y 6,5x150

Destornilladores pozi: PZ1x80 y PZ2x100



Destornilladores

D71Z107S

31.00€

Juego de 7 destornilladores planos/ pozi con mango antideslizante

Composición/ medidas (mm):

Destornilladores planos: 4x100; 5,5x125; 6,5x150 y 8x175

Destornilladores pozi: PZ1x80; PZ2x100 y PZ3x150



D3750P08S

20.00€

Juego de 8 destornilladores de precisión planos/ phillips

Composición:

Ref.	Destornill.	Punta (mm)	Longitud (mm)
D3750S30	plano	3	50
D3750S24	plano	2,4	50
D3750S20	plano	2	50
D3750S16	plano	1,6	50
D3750S10	plano	1	50
D3750P1	phillips	nº1	50
D3750P0	phillips	nº0	50
D3750P00	phillips	nº00	50



D3750T08S

19.20€

Juego de 8 destornilladores de precisión torx

Composición:

Ref.	Medida (mm)	Ref.	Medida (mm)
D3750T20	T20x50	D3750T8	T8x50
D3750T15	T15x50	D3750T7	T7x50
D3750T10	T10x50	D3750T6	T6x50
D3750T9	T9x50	D3750T5	T5x50



D3750P

Destornillador de precisión phillips

Ref.	Medida (mm)	Precio
D3750P0	PH0x50	1.95€
D3750P00	PH00x50	1.95€
D3750P1	PH1x50	1.95€



D3750S

Destornillador de precisión plano

Ref.	Medida (mm)	Precio
D3750S10	1x50	2.00€
D3750S16	1,6x50	2.00€
D3750S20	2x50	2.00€
D3750S24	2,4x50	2.00€
D3750S30	3x50	2.00€



D3750T

Llave de precisión torx

Ref.	Medida (mm)	Precio
D3750T5	T5x50	2.00€
D3750T6	T6x50	2.00€
D3750T7	T7x50	2.00€
D3750T8	T8x50	2.00€
D3750T9	T9x50	2.00€
D3750T10	T10x50	2.00€
D3750T15	T15x50	2.00€
D3750T20	T20x50	2.00€



D3750T18S

18.00€

Juego de 8 destornilladores de precisión

Composición:

Ref.	Medida (mm)	Ref.	Medida (mm)
D3750P00	P00x50	D3750T7	T7x50
D3750T4	T4x50	D3750A1	horquilla 50
D3750T5	T5x50	D3750A2	inclinación 50
D3750T6	T6x50	D3750A3	aguja 50



DR0253S

54.00€

Juego de puntas y porta puntas flexible

Composición/ medidas (mm):

- Porta puntas flexible
- Puntas phillips: #1; #2 y #3
- Puntas plano: 3; 4; 5,5; y 7
- Puntas pozi: #0; #1; #2; y #3
- Puntas hexagonal: 2; 2,5; 3; 4; 5 y 6
- Puntas torx tamperproof: T8; T10; T15; T20; T25; T27; T20 y T40
- Puntas torx: T6; T8; T9; T10; T15; T20; T25; T27; T30 y T40
- Adaptador 1/4" hexagonal
- Adaptador magnético



DR0107S

14.70€

Juego de puntas largas y porta puntas

Composición/ medidas (mm):

- Porta puntas
- Puntas dobles 65mm
- Pozi 1/ plano 5mm
- Pozi 2/ plano 6mm
- Pozi 3/ plano 7mm
- Hexagonal 3mm/ 4mm
- Hexagonal 5mm/ 6mm
- Phillips/ plano 6mm



DR04

8.20€

Mango de 1/4" con triquete de 24 dientes

Longitud total: 157mm



DBT31B

17.00€

Juego de porta puntas de mango

Composición/ medidas (mm):

- Porta puntas de mango
- Puntas phillips
- Puntas planas
- Puntas pozi
- Puntas hexagonales
- Puntas torx



Destornilladores

DBT53A

57.00€

Juego de 54 bits de 1/4" (colores)

Composición/ medidas (mm):

- Porta bits 1/4" 60mm
- 5x Bits pozi (azul) de 25mm
- 4x Bits pozi (azul) de 75mm
- 5x Bits fenda (naranja) 25mm
- 2x Bits fenda (naranja) 75mm
- 11x Bits torx (amarillo) 25mm
- 11x Bits torx (amarillo) 75mm
- 5x Bits phillips (rojo) de 25mm
- 4x Bits phillips (rojo) de 75mm
- 4x Bits hexagonales (naranja claro) 25mm
- 3x Bits hexagonales (naranja claro) 75mm



RD0638S

47.50€

Juego carraca con puntas 1/4" con 38 piezas

Composición:

- R3702 Carraca 48 dientes de 1/4"
- S04H2 10 Llaves de vaso 1/4" de 5; 6; 7; 8; 9; 10; 11; 12; 13 y 14mm
- D125FC 3 Bits planos 4; 5 y 6mm (25mm naranja)
- D125PC 4 Bits phillips PH1, PH2 x2 y PH3 (25mm rojo)
- D125ZC 3 Bits pozi PZ1, PZ2 y PZ3 (25mm azul)
- D125HC 5 Bits hexagonal 3; 4; 5; 6 y 8mm (25mm naranja claro)
- D125TC 7 Bits torx T10, T15, T20, T25, T27, T30 y T40 (25mm amarillo)
- S44H2306 Porta bits hexagonal de 1/4"
- S24H250 Extensión de 1/4" de 50mm
- S24H2100 Extensión de 1/4" de 100mm
- S26H2150A Mango de 1/4"
- S15H240 Adaptador de 1/4"



RD01032S

35.80€

Juego carraca con puntas 1/4" con 32 piezas

Composición:

- Carraca 1/4" de 60 dientes
- Porta puntas magnético
- Puntas phillips
- Puntas allen
- Puntas cuadrado
- Puntas pozi
- Puntas torx
- Puntas planas
- Puntas torx tamperproof



S08H208S

7.00€

Juego de porta puntas angular (90°)

Composición:

- 7 Puntas 1/4"



**Destornilladores****S14A4**

Juego de 8 extractores de pernos y tuercas dañadas 1/2"

Ref.	Medida (mm)	Longitud (mm)	Precio
S14A4117	17		12.00€
S14A4118	18,5		12.00€
S14A4120	20	25	12.10€
S14A4121	21,5		12.10€
S14A4123	23	30	13.00€
S14A4124	24,5	30	13.00€
S14A4126	26	30	13.10€
S14A4127	27,5	33	13.30€

S14A4108S

97.00€

Juego de 8 llaves para retirar hembras dañadas 1/2"

Composición/ medidas (mm):

Llaves: 17; 18,5; 20; 21,5; 23; 24,5; 26 y 27,5

**RD05H2**

15.00€

Llave de mano para bits

Cuadrado: 1/4"

**S29H2133S**

12.30€

Juego de porta puntas 1/4" con 33 piezas

Composición:

- Porta puntas magnético
- Puntas torx
- Puntas torx tamperproof
- Puntas perfil "Tri Wing"
- Puntas perfil "Spanner"
- Puntas hexagonales

**S29TP23S**

31.00€

Juego de puntas torx plus de 1/4" con 23 piezas

Composición:

- 5 Puntas torx plus tamperproof de 1/4": TS10H; TS15H; TS20H; TS25H y TS30H
- 5 Puntas torx plus tamperproof de 10mm: TS40H; TS45H; TS50H; TS55H y TS60H
- 5 Puntas torx plus de 1/4": IP10H; IP15H; IP20H; IP25H y IP30H
- 5 Puntas torx plus de 10mm: IP40H; IP45H; IP50H; IP55H y IP60H
- 1 Adaptador 3/8" x 10mm
- 1 Adaptador 1/4" x 1/4"
- 1 Porta puntas 1/4" x 1/4" con 60mm longitud





D125H

Puntas de 1/4" allen

Ref.	Medida (mm)	Longitud (mm)	Precio
D125H015A	1,5	25	0.35€
D125H020A	2	25	0.35€
D125H025A	2,5	25	0.35€
D125H030A	3	25	0.35€
D125H040A	4	25	0.35€
D125H050A	5	25	0.35€
D125H060A	6	25	0.35€
D125H070A	7		0.55€



D125T

Puntas de 1/4" torx

Ref.	Medida (mm)	Longitud (mm)	Precio
D125T06B	T6	25	0.30€
D125T08B	T8	25	0.30€
D125T10A	T10	25	0.35€
D125T15A	T15	25	0.35€
D125T20A	T20	25	0.35€
D125T25A	T25	25	0.35€
D125T27A	T27	25	0.35€
D125T30A	T30	25	0.35€
D125T40A	T40	25	0.35€



D125F

Puntas de 1/4" plano

Ref.	Medida (mm)	Longitud (mm)	Precio
D125F4506A	0,6x4,5	25	0.35€
D125F6512A	1,2x6,5	25	0.35€
D125F8016A	1,6x8	25	0.55€



D125P

Puntas de 1/4" phillips

Ref.	Medida (mm)	Longitud (mm)	Precio
D125P1F	PH1	25	0.35€
D125P2F	PH2	25	0.35€
D125P3F	PH3	25	0.35€



D125Z

Puntas de 1/4" pozi

Ref.	Medida (mm)	Longitud (mm)	Precio
D125Z1A	PZ1	25	0.35€
D125Z2A	PZ2	25	0.35€
D125Z3A	PZ3	25	0.35€

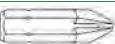

Destornilladores

los bits se suministran en paquetes de 10 unidades
los precios indicados son por unidad

D130H

Puntas de 10mm allen

Ref.	Medida (mm)	Longitud (mm)	Precio
D130H40	4	30	0.90€
D130H50	5	30	0.90€
D130H60	6	30	0.90€
D130H70	7	30	0.90€
D130H80	8	30	0.90€
D130H100	10	30	0.95€
D130H120	12	30	1.10€



D130T

Puntas de 10mm torx

Ref.	Medida (mm)	Longitud (mm)	Precio
D130T20	T20	30	0.85€
D130T25	T25	30	0.90€
D130T30	T30	30	0.90€
D130T40	T40	30	0.90€
D130T45	T45	30	0.90€
D130T50	T50	30	0.95€
D130T55	T55	30	0.95€



D150F

Puntas de 1/4" plano

Ref.	Medida (mm)	Longitud (mm)	Precio
D150F5510A	1x5,5	50	0.55€
D150F6512A	1,2x6,5	50	0.55€
D150F8012A	1,2x8	50	0.70€



D150P

Puntas de 1/4" phillips

Ref.	Medida (mm)	Longitud (mm)	Precio
D150P1A	PH1	50	0.55€
D150P2A	PH2	50	0.55€
D150P3A	PH3	50	0.55€

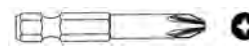

D150Z

Puntas de 1/4" pozi

Ref.	Medida (mm)	Longitud (mm)	Precio
D150Z1A	PZ1	50	0.55€
D150Z2A	PZ2	50	0.55€
D150Z3A	PZ3	50	0.55€

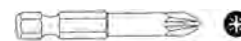

Destornilladores

D150H



Puntas de 1/4" allen

Ref.	Medida (mm)	Longitud (mm)	Precio
D150H030A	3	50	0.55€
D150H040B	4	50	0.55€
D150H050A	5	50	0.55€
D150H060B	6	50	0.55€
D150H070B	7	50	0.65€
D150H080B	8	50	0.70€

D150T



Puntas de 1/4" torx

Ref.	Medida (mm)	Longitud (mm)	Precio
D150T20A	T20	50	0.55€
D150T25A	T25	50	0.55€
D150T27A	T27	50	0.55€
D150T30A	T30	50	0.55€
D150T40A	T40	50	0.55€

D100MN



Punta hexagonal magnética de 1/4" para hembras

Ref.	Medida (mm)	Longitud (mm)	Precio
D100MN08M	8	100	3.20€
D100MN10M	10	100	3.90€
D100MN12M	12	100	4.10€
D100MN13M	13	100	4.10€
D100MN14M	14	100	4.30€

D10M3



Puntas estriadas 10mm XZN

Ref.	Medida (mm)	Longitud (mm)	Precio
D10M30M05A	M5	30	0.90€
D10M30M06A	M6	30	0.90€
D10M30M08A	M8	30	0.90€
D10M30M10A	M10	30	0.90€
D10M30M12A	M12	30	1.10€
D10M30M14A	M14	30	1.20€

D10M7



Puntas estriadas 10mm XZN

Ref.	Medida (mm)	Longitud (mm)	Precio
D10M75M05A	M5	75	1.40€
D10M75M06A	M6	75	1.50€
D10M75M08A	M8	75	1.50€
D10M75M10A	M10	75	1.50€
D10M75M12A	M12	75	1.80€
D10M75M14A	M14	75	2.00€

D175H



Puntas de 10mm

Ref.	Medida (mm)	Longitud (mm)	Precio
D175H40	4	75	1.50€
D175H50	5	75	1.50€
D175H60	6	75	1.50€
D175H70	7	75	1.50€
D175H80	8	75	1.50€
D175H100	10	75	1.60€
D175H120	12	75	1.90€

D175T



Puntas de 10mm torx

Ref.	Medida (mm)	Longitud (mm)	Precio
D175T20	T20	75	1.50€
D175T25	T25	75	1.50€
D175T30	T30	75	1.50€
D175T40	T40	75	1.50€
D175T45	T45	75	1.50€
D175T50	T50	75	1.50€
D175T55	T55	75	1.50€

D125TT



Puntas de 1/4" torx tamperproof

Ref.	Medida (mm)	Longitud (mm)	Precio
D125TT08B	T8	25	0.40€
D125TT10B	T10	25	0.40€
D125TT15B	T15	25	0.40€
D125TT20B	T20	25	0.40€
D125TT25B	T25	25	0.40€
D125TT27B	T27	25	0.40€
D125TT30B	T30	25	0.40€
D125TT35B	T35	25	0.40€
D125TT40B	T40	25	0.40€

D150MH

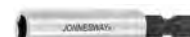

Porta puntas magneticos para puntas de 1/4"

Ref.	Medida (mm)	Longitud (mm)	Precio
D150MH1AD	10	50	2.10€

D150MH



Porta puntas magneticos encaje rápido

Ref.	Medida (mm)	Longitud (mm)	Precio
D150MH1QD	10,5	50	5.00€

D165MN

Punta hexagonal magnética de 1/4" para hembras

Ref.	Medida (mm)	Longitud (mm)	Precio
D165MN06M	6	65	2.20€
D165MN07M	7	65	2.20€
D165MN08M	8	65	2.20€
D165MN10M	10	65	2.70€
D165MN12M	12	65	3.50€
D165MN13M	13	65	3.50€

S29H2180S

38.00€

Conjunto de 180 puntas

Composición:

 phillips
 pozi
 allen
 torx

H01SA

Llaves allen cortas antideslizantes

Ref.	Medida (mm)	L1 (mm)	L2 (mm)	Precio
H01SA115	1,5	46,5	15,5	0.45€
H01SA120	2	52	18	0.45€
H01SA125	2,5	58,5	20,5	0.45€
H01SA130	3	66	23	0.70€
H01SA140	4	74	29	0.95€
H01SA150	5	85	33	1.15€
H01SA160	6	96	38	1.60€
H01SA180	8	108	44	1.65€
H01SA1100	10	122	50	2.75€

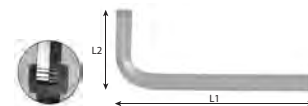
H01MH118S

43.00€

Juego de 18 llaves allen cortas

Composición/ medidas (mm):

 Llaves: 1,5; 2; 2,5; 3; 3,5;
 4; 4,5; 5; 5,5; 6; 7; 8; 9; 10;
 12; 14; 17 y 19

H01SA109S

11.50€

Juego de 9 llaves allen cortas

Sistema especial antideslizante

Composición/ medidas (mm):

 Llaves: 1,5; 2; 2,5; 3;
 4; 5; 6; 8 y 10

H01SM109S

11.50€

Juego de 9 llaves allen cortas

Composición/ medidas (mm):

 Llaves: 1,5; 2; 2,5; 3;
 4; 5; 6; 8 y 10

H02MH217S

59.90€

Juego de 17 llaves allen largas SAE

Composición/ medidas:

 Llaves: 1/16"; 5/64"; 3/32";
 7/64"; 1/8"; 9/64"; 5/32"; 3/16";
 1/4"; 5/16"; 3/8"; 7/16";
 1/2"; 9/16"; 5/8" y 3/4"

H01B

Llave allen corta

Ref.	Medida (mm)	Precio
H01B1015	1,5	0.10€
H01B1020	2	0.12€
H01B1025	2,5	0.15€
H01B1030	3	0.20€
H01B1035	3,5	0.40€
H01B1040	4	0.50€
H01B1045	4,5	0.60€
H01B1050	5	0.65€
H01B1055	5,5	0.75€
H01B1060	6	0.75€
H01B1070	7	1.00€
H01B1080	8	1.15€
H01B1090	9	1.65€
H01B1100	10	1.90€
H01B1120	12	3.60€
H01B1140	14	5.00€
H01B1160	16	6.80€
H01B1170	17	7.50€
H01B1180	18	9.50€
H01B1190	19	10.90€
H01B1220	22	15.80€



Destornilladores

H02SM109S



14.20€

Juego de 9 llaves allen largas

Composición/ medidas (mm):

Llaves: 1,5; 2; 2,5; 3; 4;
5; 6; 8 y 10



H02SM209S



14.00€

Juego de 9 llaves allen largas SAE

Composición/ medidas:

Llaves: 1/16"; 5/64";
3/32"; 1/8"; 5/32";
3/16"; 1/4"; 5/16" y 3/8"



H03MH118S



68.00€

Juego de 18 llaves allen extra largas

Composición/ medidas (mm):

Llaves: 1,5; 2; 2,5; 3; 3,5; 4;
4,5; 5; 5,5; 6; 7; 8; 9;
10; 12; 14; 17 y 19



H03SM109S



16.00€

Juego de 9 llaves allen extra largas

Composición/ medidas (mm):

Llaves: 1,5; 2; 2,5;
3; 4; 5; 6; 8 y 10



H06SA



Llaves allen extra largas con punta esférica antideslizante

Ref. Medida L1 (mm) L2 (mm)

H06SA115	1,5	91,5	15,5	0.65€
H06SA120	2	102	18	0.65€
H06SA125	2,5	114,5	20,5	0.65€
H06SA130	3	129	23	0.90€
H06SA140	4	144	29	1.20€
H06SA150	5	165	33	1.40€
H06SA160	6	186	38	2.10€
H06SM170	7			2.50€
H06SA180	8	208	44	2.65€
H06SA1100	10	234	50	3.65€

H06SA109S



16.50€

Juego de 9 llaves allen macho extra largas con punta esférica antideslizante



H06SM209S



17.90€

Juego de 9 llaves allen con punta esférica SAE

Composición/ medidas (mm):

Llaves: 1/16"; 5/64";
3/32"; 1/8"; 5/32"; 3/16";
1/4"; 5/16" y 3/8"



H03SS109S



19.00€

Juego de 9 llaves macho hexagonales largas de bajo perfil

Composición/ medidas (mm):

Llaves: 1,5; 2; 2,5;
3; 4; 5; 6; 8 y 10



H05SS109S



18.50€

Conjunto de 9 llaves macho hexagonales con punta esférica de bajo perfil

Composición/ medidas (mm):

Llaves: 1,5; 2; 2,5; 3;
4; 5; 6; 8 y 10 mm



H05SA109S



15.30€

Juego de 9 llaves allen largas con punta esférica antideslizante

Composición/ medidas (mm):

Llaves: 1,5; 2; 2,5; 3;
4; 5; 6; 8 y 10



H06MT109S



18.00€

Conjunto de 9 llaves allen largas con punta esférica

Composición/ medidas (mm):

Llaves: 1,5; 2; 2,5; 3;
4; 5; 6; 8 y 10 mm

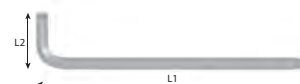

Precio

H06SM



Llave hexagonal larga de punta esférica SAE

Ref. Medida Precio

H06SM225	3/32"	0.85€
H06SM230	1/8"	0.95€
H06SM240	5/32"	1.25€
H06SM250	3/16"	1.65€
H06SM255	7/32"	1.75€
H06SM260	1/4"	1.85€
H06SM280	5/16"	2.90€
H06SM2100	3/8"	4.00€

H06W106S

66.00€

Juego de 6 llaves articuladas hexagonales de punta redonda

Composición/ medidas (mm):

Llaves: 3; 4; 5; 6; 8 y 10

H07M09S

12.50€

Juego de 9 llaves torx

Composición/ medidas (mm):

Llaves: T10; T15; T20; T25; T27; T30; T40; T45 y T50

H07MT

Llave torx en L

Ref.	Medida	Precio
H07MT10	T10	0.90€
H07MT15	T15	1.00€
H07MT20	T20	1.10€
H07MT25	T25	1.15€
H07MT27	T27	1.30€
H07MT30	T30	1.35€
H07MT40	T40	1.60€
H07MT45	T45	1.90€
H07MT50	T50	2.45€

H0816S

25.00€

Juego de 16 llaves macho con punta torx

Composición/ medidas (mm):

Llaves: T6; T8; T9; T10; T15; T20; T25; T27; T30; T40; T45; T50; T55; T60 y T70

H08MTP09S

15.00€

Juego de 9 llaves torx tamperproof

Composición/ medidas (mm):

Llaves: T10; T15; T20; T25; T27; T30; T40; T45 y T50

H08S110S

23.50€

Juego de 10 llaves torx largas tamperproof

Composición/ medidas (mm):

Llaves: T9; T10; T15; T20; T25; T27; T30; T40; T45 y T50

Destornilladores
H08ST

Llave torx larga tamperproof

Ref.	Medida	Longitud (mm)	Precio
H08ST09085	T9	80	1.50€
H08ST10090	T10	90	1.50€
H08ST15100	T15	100	1.60€
H08ST20115	T20	112	1.70€
H08ST25130	T25	126	1.70€
H08ST27145	T27	142	1.80€
H08ST30165	T30	160	2.20€
H08ST40185	T40	180	2.50€
H08ST45205	T45	200	3.10€
H08ST50230	T50	224	3.90€

H10MB08S

36.50€

Juego de 8 llaves allen dobles con mango

Composición/ medidas (mm):

Llaves: 2x100; 2,5x100; 3x100; 4x100; 5x150; 6x150; 8x200 y 10x200

H10MB
Llave allen doble con mango y punta esférica

Ref.	Medida	Precio
H10MB2100	2x100	3.00€
H10MB25100	2,5x100	3.00€
H10MB3100	3x100	3.10€
H10MB4100	4x100	3.20€
H10MB5150	5x150	3.40€
H10MB6150	6x150	3.70€
H10MB8200	8x200	5.60€
H10MB10200	10x200	7.50€

H10MT09S

44.00€

Juego de 9 llaves doble torx tamperproof con mango

Composición/ medidas (mm):

Llaves: T10x100; T15x100; T20x100; T25x100; T27x150; T30x150; T40x150; T45x200 y T50x200



Destornilladores



H10MT

Llave doble con mango torx tamperproof

Ref.	Medida	Precio
H10MT10100	T10x100	2.80€
H10MT15100	T15x100	3.30€
H10MT20100	T20x100	3.30€
H10MT25100	T25x100	3.40€
H10MT27150	T27x150	3.40€
H10MT30150	T30x150	3.80€
H10MT40150	T40x150	4.20€
H10MT45200	T45x200	6.30€
H10MT50200	T50x200	6.70€

H12S110S

22.50€

Juego de 10 llaves torx largas

Composición/ medidas (mm):
Llaves: T9; T10;
T15; T20; T25; T27;
T30; T40; T45 y T50



H15M105S

17.70€

Juego de 5 llaves XZN en "L"

Composición/ medidas (mm):
Llaves: M5; M6; M8; M10 y M12



H12S

Llaves torx extra largas

Ref.	Medida	L1 (mm)	L2 (mm)	Precio
H12S09085	T9	85	5	1.30€
H12S10090	T10	90	5,5	1.30€
H12S15100	T15	100	8	1.35€
H12S20115	T20	115	12,5	1.50€
H12S25130	T25	130	18	1.55€
H12S27145	T27	145	24,5	1.75€
H12S30165	T30	165	40	2.10€
H12S40185	T40	185	62	2.50€
H12S45205	T45	205	98	2.90€
H12S50230	T50	230	128	4.00€



H20MT

Llaves torx dobles con mango

Ref.	Medida	L1 (mm)	L2 (mm)	Precio
H20MT10	T10	110	15	3.20€
H20MT15	T15	120	15	3.30€
H20MT20	T20	125	16	3.90€
H20MT25	T25	135	16	4.00€
H20MT27	T27	145	16	4.20€
H20MT30	T30	155	16	4.60€
H20MT40	T40	165	16	5.30€
H20MT45	T45	185	16	6.00€
H20MT50	T50	205	20	7.20€



H20MB1037S



64.00€

Juego de 9 llaves allen de punta esférica con mango y 28 puntas

Composición/ medidas (mm):

H20MB Llaves: H1,5X100; H2X100; H2,5X110; H3X120; H4X125; H5X155; H6X165; H8X185 y H10X210
 Puntas phillips: PH1; PH2 y PH3
 Puntas pozi: PZ1; PZ2 y PZ3
 Puntas torx: T10; T15; T20; T25; T27; T30; T35 y T40
 Puntas planas: 3; 4; 5; 6 y 7
 Puntas XZN: M4; M5 y M6
 Puntas cuadradas: 1; 2 y 3
 Puntas spanner: 4 y 6

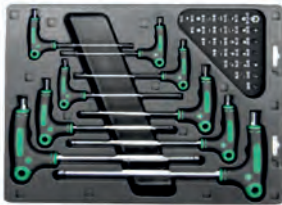

H20MT09S



61.00€

Juego de 9 llaves torx dobles con mango

Composición/ medidas (mm):

Llaves: T10x110; T15x120; T20x125; T25x135; T27x145; T30x155; T40x165; T45x185 y T50x205



H22S109S



21.50€

Juego de 9 llaves allen extra largas XZN

Especial para quitar los tornillos dañados

Composición/ medidas (mm):

Llaves: 1,5; 2; 2,5; 3; 4; 5; 6; 8 y 10

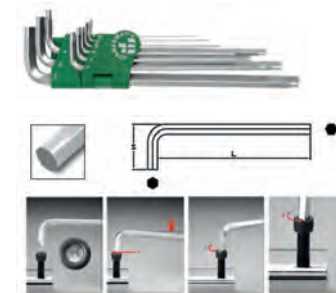

JR72

TOYOTA CAETANO
MOTORSPORT

Martillos

M03025

29.50€

Mazo de metal

Peso: 1 330g



M040

Martillo con cabeza redonda y punta esférica

Ref.	Peso (g)	Longitud (mm)	Precio
M04008	395	278	12.50€
M04012	527	283	13.50€
M04016	780	327	15.50€
M04024	1 063	383	21.00€
M04032	1 208	385	22.50€



M010

Martillo de ala de acero

Ref.	Peso (g)	Longitud (mm)	Precio
M01016	777	320	29.00€
M01020	875	350	31.50€



M05020

18.50€

Martillo de carpintero

Peso: 830g

Longitud: 330mm



M060

Mazo

Ref.	Peso (g)	Longitud (mm)	Precio
M06030	1 550	263	21.00€
M06040	2 250	276	24.00€



M07016

19.00€

Martillo plástico y goma

Peso: 840g

Longitud: 314mm



M07016-ACE

3.00€

Tapa amarilla para recambio M07016



M07016-TPR

1.80€

Tapa negra para recambio M07016



JONNESWAY

M29

Martillo plástico y goma intercambiables

Ref.	Diámetro (mm)	Longitud (mm)	Precio
M2927	27	270	21.00€
M2932	32	290	24.50€



M2927

Tapa para martillo M2927

Ref.	Color	Precio
M2927-T1	blanca	2.60€
M2927-T2	amarilla	3.90€



M2932

Tapa para martillo M2932

Ref.	Color	Precio
M2932-T1	blanca	3.10€
M2932-T2	amarilla	3.60€



M2940

Tapa para martillo M2940

Ref.	Color	Precio
M2940-T1	blanca	4.30€
M2940-T2	amarilla	6.50€



M2950

Tapa para martillo M2950

Ref.	Color	Precio
M2950-T1	blanca	5.90€
M2950-T2	amarilla	8.80€



M09

Martillo de mecánico

Ref.	Peso (g)	Longitud (mm)	Precio
M09100	100	260	8.50€
M09200	200	280	9.50€
M09300	300	300	11.30€
M09500	500	320	14.00€
M09800	800	350	18.00€
M091000	1 000	360	22.80€



M110

Martillo antirrebote de goma

Ref.	Peso (g)	Longitud (mm)	Precio
M11035	400	260	16.30€
M11045	520	286	19.50€
M11065	1500	370	33.50€



M601
Punzón de pico

Ref.	D (mm)	D1 (mm)	L (mm)	Precio
M60103	3	9,5	120	1.90€
M60104	4	9,5	120	2.30€
M60105	5	12	120	3.00€

M611
Cinzel

Ref.	D (mm)	D1 (mm)	L (mm)	Precio
M61110	10	9,5	150	2.65€
M61112	12	9,5	130	2.70€
M61113	13	9,5	150	2.75€
M61116	16	12,7	180	3.80€
M61119	19	15,8	180	5.30€
M61122	22	15,8	200	6.00€
M61125	25	19	200	8.50€

M621
Punzón

Ref.	D (mm)	D1 (mm)	L (mm)	Precio
M62102	2	9,5	120	2.10€
M62103	3	9,5	120	2.10€
M62104	4	9,5	120	2.10€
M62105	5	9,5	120	2.10€
M62106	6	9,5	120	2.10€
M62108	8	9,5	120	2.15€

M631
Punzones

Ref.	D (mm)	D1 (mm)	L (mm)	Precio
M63102	2	8	115	2.30€
M63103	3	8	125	2.40€
M63104	4	9,5	150	2.80€
M63105	5	9,5	165	3.10€
M63106	6	12,7	180	3.60€
M63108	8	12,7	180	3.70€

M641
Buril

Ref.	D (mm)	D1 (mm)	L (mm)	Precio
M64105	5	9,5	130	3.40€

Varios

los bits se suministran en paquetes de 10 unidades
los precios indicados son por unidad

M63106S 18.50€

Juego de 6 punzones

Composición/ medidas (mm):
2x8x115; 3x8x125;
4x9,5x150; 5x9,5x165;
6x12,7x180 y 8x12,7x180



M63M106S 20.00€

Juego de 6 punzones cromo

Composición/ medidas (mm):
2x8x115; 3x8x125; 4x9,5x150;
5x9,5x165; 6x12,7x180 y 8x12,7x180

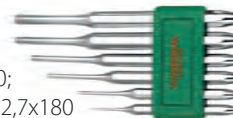

M64105S 13.50€

Juego de 5 punzones y cortafrios

Composición/ medidas (mm):
Punzón: 2x8x115; 3x8x125;
4x9,5x150; 5x9,5x165; 6x12,7x180
Cortafrio: 8x12,7x180



M64M105S 14.80€

Juego de 5 punzones y cortafrios cromados

Composición/ medidas (mm):
Punzón: 3x 9,5x120
Punzón pico: 2x9,5x120
Cinzel: 12x9,5x130
Botadores: 4x9,5x150
Cortafrio: 5x9,5x130



M61H1 Cortafrios con mango de protección

Ref.	Tipo	Medida (mm)	Precio
M61H116	16	170	5.80€
M61H119	19	190	7.00€
M61H124	24	220	10.50€



M62H1 Punzón con mango de protección

Ref.	Tipo	Medida (mm)	Precio
M62H102	2	185	4.90€
M62H103	3	185	4.90€
M62H104	4	185	4.90€
M62H106	6	185	4.90€



M63H1

Punzones con mango de protección

Ref.	Tipo	Medida (mm)	Precio
M63H103	3	150	3.90€
M63H105	5	200	5.10€
M63H106	6	210	6.40€
M63H108	8	220	7.00€



AI030045

112.00€

Juego de 4 cinceles con protección



MF05

Limas

Ref.	Tipo	Medida (mm)	Precio
MF05A	chata	200	8.70€
MF05B	redonda	200	7.50€
MF05C	media caña	200	9.00€
MF05D	cuadrada	200	8.70€
MF05E	triangular	200	8.30€

MF05S

50.00€

Juego de 5 limas de 200mm

Composición:
MF05A Lima chata
MF05B Lima redonda
MF05C Lima media caña
MF05D Lima cuadrada
MF05E Lima triangular



MFM06S

25.50€

Juego de 6 mini limas de 100mm

Composición:
Mini lima redonda
Mini lima triangular
Mini lima cuadrada
Mini lima media caña
Mini lima plana
Mini lima plana en pico



MHS100AG

19.00€

Sierra



MHS300

19.00€

Sierra multiángulos

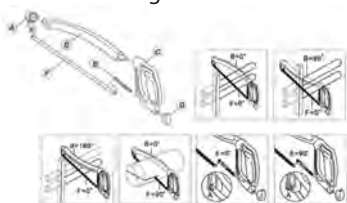

P9601

12.30€

Navaja pela cables



MK2040

10.20€

Cuter de cuchilla retráctil
Con 2 cuchillas de reemplazo



MK2040-B

1.50€

Cuchilla de cuter MK2040 - 5 unidades

MK2080

11.00€

Cuter de cuchilla retráctil
Con 2 cuchillas de reemplazo



D

MKS27

22.20€

Juego de cuter

Composición:

Cuter
Raspador
Accesorios



MKS27

Cuchilla raspadora - 100 unidades

Ref.	Tipo	Medida (mm)	Precio
MKS27-12	A	12	20.60€
MKS27-16	B	16	22.90€
MKS27-16A	C	(53°) 16	24.00€
MKS27-20	D	20	19.50€

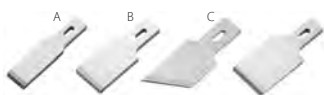

Varios

MT0201

4.00€

Flexómetro

Cuerpo en plástico ABS resistente al choque
Longitud: 3m



MT0703

8.90€

Flexómetro

Cuerpo en plástico ABS resistente al choque
Longitud: 8m



MTC1

Calibre lectura vigesimal

Ref.	Longitud (mm)	Precio
MTC1150	150	45.00€
MTC1200	200	71.00€
MTC1300	300	105.00€



MTC153

17.00€

Escuadra metálica

Dimensiones: 300x40x1 mm



MTC156

2.80€

Regla en metal

Dimensiones: 334x23,7x1 mm



MTC2

Calibre digital

Ref.	Longitud (mm)	Precio
MTC150	150	67.00€
MTC200	200	109.00€



MTC3
Compás de precisión puntas rectas

Ref.	Longitud (mm)	Precio
MTC306	150	19.00€
MTC308	200	20.00€

MTC408
Compás de precisión puntas curvadas para exteriores

Longitud: 200mm

20.50€

MTC508
Compás de precisión puntas curvadas para interiores

Longitud: 200mm

19.00€

MTM1
Micrómetro exteriores

Ref.	Medida (mm)	Precio
MTM1025	0-25	37.50€
MTM1050	25-50	42.00€
MTM1075	50-75	46.00€
MTM1100	75-100	51.00€

AG010207
Lámpara de Leds

Incluye: Cargador 220v AC/ 5v DC y cable USB

Dimensiones: 375x30x30mm Potencia: 15W
 Cargador: 220v/ 50Hz Capacidad da batería: 2,5 a 10h
 Flujo luminoso: 410 lumen Tiempo de carga: 3,5 a 4h
 Iluminancia máxima: 935 luz proyectada a 50cm
 Batería recargable : Li-ion 3,7v 2 200mAh

84.00€

AG010224
Lámpara flexible de Leds

Longitud: 168mm Batería: Li-ion 3,7v - 2.2Ah
 Cargador: AC/DC Haste flexible 360°
 Base magnética Regulador de intensidad
 Autonomía: 2 a 8h (variable de acuerdo con a intensidad)

72.00€

C-DM1
Barra magnética

Dimensiones: 475x52x17mm

24.80€

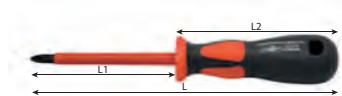

DV13P
Destornillador phillips aislado (1000 Volts)

Ref.	Medida	L1 (mm)	L2 (mm)	L (mm)	Precio
DV13P060	PH0	60	98	158	3.70€
DV13P180	PH1	80	104	184	4.30€
DV13P2100	PH2	100	110	210	4.70€
DV13P3150	PH3	150	120	270	6.50€

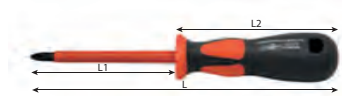
DV13S
Destornillador plano aislado (1000 Volts)

Ref.	Medida (mm)	L1 (mm)	L2 (mm)	L (mm)	Precio
DV13S275	2,5	75	98	173	3.60€
DV13S4100	4	100	98	198	4.30€
DV13S5125	5,5	125	104	229	4.30€
DV13S6150	6,5	150	110	260	4.50€
					5.90€
					6.80€

DV13Z
Destornillador pozi aislado (1000 Volts)

Ref.	Medida (mm)	L1 (mm)	L2 (mm)	L (mm)	Precio
DV13Z060	PZ0x60	60	98	158	3.90€
DV13Z180	PZ1x80	80	104	184	4.80€
DV13Z2100	PZ2x100	100	110	210	5.20€
DV13Z3150	PZ3x150	150	120	270	6.70€

DV13PP07S
42.00€
Juego de destornilladores aislados planos/ phillips (1000 Volts)

Composición/ medidas (mm):

 Destornilladores planos: 4x100; 5,5x125 y 6,5x150
 Destornilladores phillips: PH0x60; PH1x80 y PH2x100
 Busca-polos

DV41M
Vasos destornilladores aislados con mango (1000 Volts)

Ref.	Medida	Longitud (mm)	Precio
DV41M5	M5	125	7.10€
DV41M6	M6	125	7.10€
DV41M7	M7	125	7.10€
DV41M8	M8	125	7.20€
DV41M10	M10	125	7.30€
DV41M13	M13	125	8.30€

DV4118SV
163.00€
Tablero EVA con herramientas aisladas (1000 volts)

Composición:

Ref.	Destornill.	Medidas (mm)
DV13S275	plano	2,5x75
DV13S3100	plano	3x100
DV13S4100	plano	4x100
DV13S5125	plano	5,5x125
DV13P060	phillips	PH0x60
DV13P180	phillips	PH1x80
DV13P2100	phillips	PH2x100
DV13P3150	phillips	PH3x150
DV41M	vaso mango	M4x125; M5x125; M5,5x125; M6x125; M7x125; M8x125; M9x125; M10x125; M11x125 y M12x125

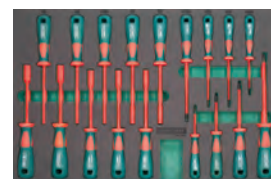

DV41M06S 48.50€

Juego de 6 vasos destornilladores aislados con mango (1000 Volts)

Composición/ medidas:

Vasos destornilladores: M5; M6; M7; M8; M10 y M13



DV15109S 36.00€

Bolsa de 7 llaves aislantes (fenda/phillips)



MKV7 11.60€

Cuter aislado 1000V

Longitud: 180mm

Hoja: 50mm



MKV7-K 16.50€

Cuchilla para cutter aislado 1000 volts - 4 unidades



MKV8 19.50€

Navaja aislada 1000V

Longitud: 180 mm

Cuchilla: 50mm



PV0118 24.50€

Alicata universal

Cumple la norma IEC 60900

Ref.	Longitud (mm)	4.0	3.0	2.0	1.6
	200	<input type="radio"/>	<input type="radio"/>	<input type="radio"/>	<input type="radio"/>



PV08

Alicata universal

Cumple la norma IEC 60900

Ref.	Longitud (mm)	4.0	3.0	2.0	1.6	Precio
PV0816	160	<input type="radio"/>	<input type="radio"/>	<input type="radio"/>	<input type="radio"/>	18.60€
PV0817	180	<input type="radio"/>	<input type="radio"/>	<input type="radio"/>	<input type="radio"/>	20.50€



PV0518 28.00€

Alicata corta cables (trabajo intensivo)

Cumple la norma IEC 60900

Longitud: 200mm

Capacidad de corte: Ø13/60mm



PV0918 23.70€

Alicata de corte

Cumple la norma IEC 60900

Ref.	Longitud (mm)	4.0	3.0	2.0	1.6
	200	<input type="radio"/>	<input type="radio"/>	<input type="radio"/>	<input type="radio"/>



PV1016 19.80€

Alicata de corte diagonal

Cumple la norma IEC 60900

Ref.	Longitud (mm)	4.0	3.0	2.0	1.6
	160	<input type="radio"/>	<input type="radio"/>	<input type="radio"/>	<input type="radio"/>



PV1116 19.30€

Alicata de puntas redondas

Cumple la norma IEC 60900

Longitud: 160mm



PV1118 20.50€

Alicata de puntas

Cumple la norma IEC 60900

Ref.	Longitud (mm)	4.0	3.0	2.0	1.6
	200	<input type="radio"/>	<input type="radio"/>	<input type="radio"/>	<input type="radio"/>



PV1218 21.50€

Alicata de puntas redondas

Cumple la norma IEC 60900

Ref.	Longitud (mm)	4.0	3.0	2.0	1.6
	200	<input type="radio"/>	<input type="radio"/>	<input type="radio"/>	<input type="radio"/>



PV1416 18.60€

Alicata de puntas chatas

Cumple la norma IEC 60900

Longitud: 160mm



PV1516 19.00€

Alicata de pelar cables (trabajo intensivo)

Cumple la norma IEC 60900

Longitud: 160mm



PV28110

26.50€

Alicate ajustable

Cumple la norma IEC 60900

Longitud: 275mm

PV4006

24.00€

Alicate de puntas redondas

Cumple la norma IEC 60900

Longitud: 200mm

PSV218SP

100.00€

Juego de 3 herramientas aisladas 1 000V

Composición/ medidas en mm:

2 Destornilladores phillips aislados: PH1x80; PH2x100

2 Destornilladores plano aislados: 5x125; 6x150

1 Alicata de corte diagonal

1 Alicata de universal

1 Alicata de puntas

1 Busca polos

B
PSV110SC

163.00€

Juego de 10 herramientas aisladas 1 000V

Composición:

4 Alicates

4 Destornilladores/ phillips

1 Navaja

1 Buscapolos

C
S03V21
Llaves de vaso 1/4" aisladas a 1 000V

Ref.	Medida (mm)	Longitud (mm)	Precio
S03V2106	6	41	5.10€
S03V2108	8	41	5.10€
S03V2110	10	41	5.10€
S03V2114	14	41	6.00€

S03V31
Llaves de vaso 3/8" aisladas a 1 000V

Ref.	Medida (mm)	Longitud (mm)	Precio
S03V3108	8	44,5	7.00€
S03V3110	10	44,5	7.00€
S03V3112	12	44,5	7.20€
S03V3113	13	44,5	7.40€
S03V3114	14	44,5	7.60€
S03V3117	17	44,5	8.20€
S03V3119	19	46	8.70€
S03V3122	22	46	10.00€

S03V41
Llaves de vaso 1/2" aisladas a 1 000V

Ref.	Medida (mm)	Longitud (mm)	Precio
S03V4110	10	55	8.20€
S03V4111	11	55	8.50€
S03V4112	12	55	8.70€
S03V4113	13	55	8.70€
S03V4114	14	55	9.20€
S03V4117	17	55	9.30€
S03V4119	19	57	9.40€
S03V4122	22	57	11.00€
S03V4124	24	57	11.50€
S03V4127	27	59	13.00€
S03V4132	32	59	16.00€

S03V3116SC

250.00€

Juego de 16 piezas 3/8" con carraca aislado a 1 000V

Composición/ medidas en mm:

RV033 Carraca aislado 200

S43V38 Extensión flexible 200

S25V36 Prolongador 150

S25V310 Prolongador 250

S03V3 Llaves de vaso: 8; 10; 12; 13; 14; 17; 19 y 22

S09V3 Puntas: 4; 5; 6 y 8

B

Herramienta aislada a 1 000V

S03V3136SV

465.00€

Tablero EVA con herramientas de 1/4" e 3/8" aisladas a 1 000V

Composición/ medidas en mm:

RV032	Carraca de 1/4"
RV033	Carraca de 3/8"
S43V28	Extensión flexible de 1/4" de 125
S43V38	Extensión flexible de 3/8" de 200
S25V24	Prolongador de 1/4" de 100
S25V3	Prolongador de 3/8" de 150 e 250
S03V21	10 Llaves de vaso: 5 a 14
S03V31	11 Llaves de vaso: 8 a 22
S09V2H	4 Puntas de 1/4" de 60
S09V3H	4 Puntas de 3/8" de 60

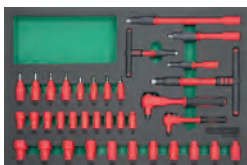

S03V4120SC

355.00€

Juego de 20 piezas 1/2" con carraca aislado a 1 000V

Composición/ medidas en mm:

RV034	Carraca aislado 250
S43V48	Extensión flexible 200
S25V45	Prolongador 125
S25V410	Prolongador 250
S03V4	Llaves de vaso: 10; 11; 12; 13; 14; 17; 19; 22; 24; 27 y 32
S09V4	Puntas: 4; 5; 6; 8 y 10



S03V4124SV

415.00€

Tablero EVA con herramientas 1/2" aisladas a 1 000V

Composición/ medidas en mm:

RV034	Carraca de 1/2"
S43V48	Extensión flexible de 1/2" de 200
S25V4	Prolongador de 125 e 250
S03V41	13 Llaves de vaso: 10 a 32
S09V41H	5 Puntas de 200
WV27AS8	Llave inglesa de 150
MKV7	Cutter



S09V3H

Llaves de vaso hexagonal 3/8" aisladas a 1 000V

Ref.	Medida (mm)	Longitud (mm)	Precio
S09V3H4	4	60	7.40€
S09V3H5	5	60	7.40€
S09V3H6	6	60	7.60€
S09V3H8	8	60	8.50€



S09V41H

Llaves de vaso 3/8" aisladas a 1 000V

Ref.	Medida (mm)	Longitud (mm)	Precio
S09V41H4	4	120	10.40€
S09V41H5	5	120	10.40€
S09V41H6	6	120	10.40€
S09V41H8	8	120	10.40€
S09V41H10	10	120	11.50€



S25V3

Prolongador 3/8" aislado a 1 000V

Ref.	Longitud (mm)	Peso (g)	Precio
S25V36	150	150	25.00€
S25V310	250	250	30.00€



S25V4

Prolongador 1/2" aislado a 1 000V

Ref.	Longitud (mm)	Peso (g)	Precio
S25V45	150	210	28.00€
S25V410	250	410	31.00€



S43V
Extensión flexible aislada a 1 000V

Ref.	Cuadradillo	Longitud (mm)	Peso (g)	Precio
S43V38	3/8"	200	240	36.50€
S43V48	1/2"	250	330	39.00€

RV03
Carraca aislado a 1 000V

Ref.	Cuadradillo	Longitud (mm)	Peso (g)	Precio
RV032	1/4"	150	140	41.50€
RV033	3/8"	200	300	50.00€
RV034	1/2"	250	570	58.00€

W23V1
Llaves estrella aisladas a 1 000V

Ref.	Medida (mm)	Longitud (mm)	Precio
W23V108	8	164	19.00€
W23V110	10	174	19.60€
W23V111	11	184	20.40€
W23V112	12	184	20.40€
W23V113	13	205	22.50€
W23V114	14	205	22.50€
W23V116	16	221	25.00€
W23V117	17	221	25.50€
W23V118	18	237	29.00€
W23V119	19	237	29.00€
W23V121	21	257	32.00€
W23V122	22	257	32.00€
W23V124	24	287	37.50€

W25V1
Llaves fijas 3/8" aisladas a 1 000V

Ref.	Medida (mm)	Longitud (mm)	Precio
W25V108	8	104	13.50€
W25V109	9	104	14.00€
W25V110	10	114	14.50€
W25V113	13	154	15.70€
W25V114	14	154	16.00€
W25V117	17	170	17.50€
W25V118	18	180	20.00€
W25V119	19	180	20.00€
W25V121	21	202	25.00€
W25V122	22	202	25.00€
W25V124	24	237	26.50€

W25V1125SV
560.00€
Tablero EVA con herramientas aisladas a 1 000V

Composición/ medidas en mm:

- W23V11 9 Llaves estrella 10 a 19mm
- W25V 13 Llaves fijas 7 a 24mm
- PV0818 Alicata universal 200mm
- PV1016 Alicata de corte 160mm
- PV1116 Alicata de puntas 160mm

WV27AS10
52.50€
Llave ajustable aislada 1000V

 Apertura: 33mm
 Longitud: 200mm



JONNESWAY®

Herramientas Profissionais





JONNESWAY®

**Herramienta Especial
Mecánica**



Mecánica



Pesados



Motocicletas



Accesorios



Chapista

Herramienta específica - gama automóvil

AB030056

40.00€

Inflador de aire para apertura de puerta

Longitud: 230mm



AB030061

24.00€

Herramienta para retirar el brazo limpia parabrisas



AE040020

68.00€

Cilindro hidráulico

Longitud: 140mm cerrado | 215mm extendido
Capacidad: 2t



AE150005

115.00€

Dos caballetes de 3t con apoyo de goma

Altura máxima: 440mm
Altura mínima: 290mm



AE300064

245.00€

Kit prueba de presión para radiadores con 17 piezas

Composición:

AE30064-02 Audi A4, A5, A6

AE30064-03 Opel, Ford, VW

AE30064-04 BMW

AE30064-05 BMW

AE30064-06 Volvo, Citroën, Renault, Fiat, Peugeot

AE30064-07 Audi, VW

AE30064-08 Sede ajustable

AE30064-09 Pino união 50mm

AE30064-10 Pino unión 35mm

AE30064-11 Pino unión 27mm

AE30064-12 Adaptador para 8; 9 y 11

AE30064-13 Adaptador

AE30064-14 Fijador

AE30064-15 Honda, Toyota

AE30064-16 Mitsubishi, Honda, Ford, Nissan, Mazda



AE3000

Tapones para prueba del radiador

Ref.	Precio
AE300064-02	20.50€
AE300064-03	20.50€
AE300064-04	21.00€
AE300064-05	19.00€
AE300064-06	16.50€
AE300064-07	16.50€
AE300064-15	24.80€
AE300064-16	24.80€



AE300100-040

23.10€

Tapones para kit de presión de radiadores - Ford

Aplicable en el kit AE300064



AE300100-042

23.10€

Tapones para kit de presión de radiadores - Ford

Aplicable en el kit AE300064



AE300100-060

24.40€

Tapones para kit de presión de radiadores - Mercedes

Aplicable en el kit AE300064



AE300103

19.70€

Bandeja de recoger aceite y anticongelante

Dimensiones: 600x450x180mm

Capacidad: 16l



AE300152

200.00€

Kit prueba de presión de radiador con 5 piezas



AE300173

20.20€

Sangrador de líquido de embrague y frenos
Fácil, rápido y eficiente utilizando el aire de los neumáticos



AE300176-A

49.00€

3 Adaptadores especiales para VW/ Audi/ Mercedes



AE300212

117.00€

Distribuidor de aceite de transmisiones

Dimensiones: 240x200x440mm
Capacidad: 4l
Peso: 1 600g
Bomba de mano y 4 adaptadores



AE310002

270.00€

Conjunto extractor hidráulico con accesorios

Capacidad: 90-145mm



AE310006

105.00€

Conjunto de 2 extractores guillotina

Capacidad: 30-75mm



AE3100

Separadores media luna

Ref.	Medida (mm)	Precio
AE310024	30-50	20.50€
AE310025	50-75	33.00€
AE310026	75-105	52.00€
AE310027	105-150	115.00€



AE310008

166.00€

Extractor interior y exterior

Capacidad: 15-30 y 30-80mm interna
15-80mm externa



AE310010A

128.00€

Juego de extractor semieje



AE310013

85.00€

Extractor universal de buje de la rueda

Capacidad: 90-140 y 130-180mm



AE310014

165.00€

Extractor de buje de la rueda y semieje

Capacidad: 90-140 y 130-180mm



AE310016

56.50€

Extractor semieje



AN010045

10.30€

Separador de rótulas



AE3100

Extractor de 3 brazos

Ref.	Tamaño	Apertura (mm)	Capacidad (t)
AE310034	3"	40-76	2
AE310035	4"	50-102	5
AE310037	8"	80-203	12
AE310038	12"	120-305	18

AE310023

49.00€

Extractor de rótulas



Precio

19.70€

27.50€

105.00€

235.00€

AE310062

60.00€

Extractor de rodamientos

Longitud: 300mm

Capacidad: 10-50mm



AE310063

73.00€

Extractor para rodamientos pequeños

Especialmente adecuado para la eliminación de pequeños cojinetes en el automóvil, reparación de instalaciones industriales y domésticas.

Capacidad: 1t

Apertura: 19 a 45mm

Rango de profundidad: 73mm



AE310087

85.00€

Extractor universal de rótulas

Especialmente diseñado para su uso en situaciones de espacio reducido

Aplicable: Audi, VW, BMW, Ford, Mercedes

(W170, W202, W210, W220), Opel, Mitsubishi ...



AE310099

120.00€

Extractor de 2 y 3 brazos para interiores y exteriores

Capacidad: 20t

Apertura: 76-178mm



Alterável para:



AE310066

25.50€

Extractor para volantes de dirección

Aplicable: Opel, Ford entre otros



AE310073

30.50€

Extractor de rótulas

Apertura: 20mm



AE310122

94.00€

Extractor de rótulas



AE310077

37.00€

Extractor de rótulas

Apertura: 20mm



AE310150

85.00€

Extractor de poleas



AE3101
Extractor de 3 brazos

Ref.	Ø (mm)	Ancho (mm)	Altura (mm)
AE310109A	18	40	35
AE310110	23	50	45
AE310112	40	80	80



Precio

19.50€

42.50€

85.00€

AE3101
Extractor de 2 brazos

Ref.	Ajuste Int. (mm)	Ajuste Ext. (mm)	Altura (mm)
AE310146B	25-80	70-130	100
AE310146D	50-160	105-220	150
AE310146E	60-200	120-270	150
AE310146G	80-350	160-420	200
AE310146H	110-520	195-600	200



Precio

57.00€

100.00€

130.00€

312.00€

452.00€

AE310172
Juego de extractores

Composición:

Extractor de 2ton

Piernas cortas: 85mm

Piernas largas: 185mm

Extractor de 6ton

Piernas cortas: 140mm

Piernas largas: 280mm

Cilindro de 30ton



840.00€

AE310180
Juego de extractor de rótulas con accesorios ajustables

Apertura: 20; 22; 24; 27 y 30mm



280.00€

AE310183
Extractor barra de dirección

130.00€

AE320023
Compresor de grapas para amortiguadores

Apertura: 270mm



40.00€

AE320034
Juego de extractor de grapas MacPherson

525.00€

AE320035
Herramienta para fijación MacPherson

170.00€

AE320044
Compresor de muelles

Apertura: 300mm



72.00€

AE300154B 123.00€

Refractómetro

Aparato apto para comprobar líquido de baterías, líquido refrigerante y AdBlue



AE300168 103.00€

Verificador de fugas de la cabeza del cilindro

Equipo para comprobar las fugas en la combustión.

La utilización de líquido contrastante permite comprobar la existencia de dióxido de carbono en el depósito del líquido de refrigeración, denunciando así la existencia de fugas en la combustión.



AE300168-1 42.50€

Líquido para verificador de la cabeza del cilindro

Botella de 250ml

AI020074 150.00€

Detector de fugas para cilindros



AE300201 130.00€

Pistola tornado pulverizador

Dimensiones: 330x105x270mm

Capacidad copa: 1l

Peso: 780g

Ruido: 85dB

Alimentación: 6,2bar

Consumo de aire: 56,6l/min

Entrada de aire: 1/4"



AE300202 125.00€

Pistola tornado pulverizador/ espuma

Dimensiones: 330x105x260mm

Capacidad copa: 1l

Peso: 950g

Ruido: 70dB

Alimentación: 6,2bar

Entrada de aire: 1/4"

Consumo de aire: 56,6l/min



AE300204 22.50€

Jeringa para líquidos

Hecho de plástico resistente al líquido de frenos y anticongelante. Permite succión, adición y la visualización del fluido.

Capacidad: 200cc

Peso: 294g



AE300205 51.70€

Jeringa para líquidos

Hecho de plástico resistente al líquido de frenos y anticongelante. Permite succión, adición y la visualización del fluido.

Capacidad: 1,5l

Peso: 900g

Aplicación: aceite caja velocidades y diferencial



AE300211 95.00€

Jeringa para líquidos con 5 adaptadores

Hecho de plástico resistente, aplicable a todos los tipos de aceites y combustibles. Permite succión, adición y la visualización del fluido.

Capacidad: 1,5l



AE300206 15.90€

Base recogedora de aceites para latas 20/ 30l

Diseñado para la recogida de los restos de aceite filtros, nuevos o usados, y otros envases (enchufe directo en latas de 20/ 30l)

Hecho de polietileno de alta densidad resistente

Capacidad: 3l

Peso: 500g

Diámetro: 350mm



AE300207 54.00€

Base recogedora de aceite para bidones 200l

Diseñado para la recogida de los restos de aceite filtros, nuevos o usados, y otros envases (enchufe directo en la parte superior de los bidones de 200l)

Hecho de polietileno de alta densidad resistente

Capacidad: 20l

Peso: 1 700g

Diámetro: 600mm



AE300215
38.00€
Pistola de limpieza de motores

Cuadrado ajustable
 Capacidad: 1l
 Consumo de aire: 160 l/m
 Entrada de aire: 1/4"
 Presión de trabajo: 5-8 Bar

AE300220
82.00€
Recogedor de residuos de aceite

Dimensiones: 174x197x486mm
 Capacidad: 2l

AG010034
6.30€
Bolígrafo magnético

Longitud: 580mm

AG010035
24.70€
Dedo magnético con luz y espejo

AG010163A
8.70€
Dedo magnético flexible

AG010164
40.00€
Imán flexible con luz y espejo

Luz: blanca, azul y UV

AG010046
9.60€
Punta para válvulas de los neumáticos

Longitud: 230mm

AG010159
6.50€
Adaptador para manguera de aire de los neumáticos

Salida: 6mm

AG010059
31.00€
Juego de 4 extractores de casquillos

Medidas: 6; 8; 10 y 12mm

AG010059
Extractor de casquillos

Ref.	Medida (mm)	Precio
AG010059-6	6	6.90€
AG010059-8	8	7.00€
AG010059-10	10	7.20€
AG010059-12	12	7.20€

AG010036
8.90€
Bandeja magnética redonda

AG010111
29.50€
Bandeja magnética rectangular

AS-0065
39.90€
Soporte magnético para máquina de impacto y 4 llaves

AG010049
9.50€
Juego de 5 extractores tornillos

AG010089
17.00€
Medidor digital de presión de aire

Baterías de litio
 Pantalla LCD
 Auto calibración
 Auto off



AG010099

32.50€

Llaves de cruz para tuercas de ruedas

Medidas: 17; 19 y 21mm



AG010225

27.00€

Llave de ruedas con 3 piezas

Posibilidad de utilización en + o en "T"

Medidas: 17; 19 y 21mm

Tubo perforado 355mm con llave de 19 y 21mm
Tubo perforado 395mm con llave de 17mm
Adaptador 1/2"



AG010109

21.00€

Troncha tuercas

Medidas: 12-18 y 16-22mm



AG010118A

25.00€

Llave de apriete angular 1/2"



AG010147

13.50€

Llave de apertura angular con cuadradillo 1/2"



AG010208

57.00€

Juego de quitar tornillos torx dañados con 8 piezas

Composición:

Medida (mm)	Longitud (mm)	Hex (mm)
3	38	10
4	38	10
5	38	10
6	38	10
7	38	12
8	38	12
10	38	14
12	38	14



AG10001SP-G

4.30€

Medidor de paso de rosca



AG010227

320.00€

Juego de machos y terrajas con 53 piezas

Composición:

- 15 Machos 38mm: M6x0,75; M6x1,0; M8x1,0; M8x1,25; M10x1,25; M10x1,5; M12x1,25; M12x1,5; M12x1,75; M14x1,5; M14x2,0; M16x1,5; M16x2,0; M18x1,5 y M18x2,5
- 6 Machos 50mm: M20x1,5; M20x3,0; M22x1,6; M22x2,5; M24x1,5 y M24x3,0
- 21 Terrajas: M6x0,75; M6x1,0; M8x1,0; M8x1,25; M10x1,25; M10x1,5; M12x1,25; M12x1,5; M12x1,75; M14x1,5; M14x2,0; M16x1,5; M16x2,0; M18x1,5; M18x2,5; M20x1,5; M20x2,5; M22x1,5; M22x2,5; M24x1,5 y M24x3,0

5 Extractores

- 1 Porta terrajas
- 1 Giramachos (M6 - M25)
- 1 Giramachos (M4 - M12)
- 1 Destornillador phillips PH2 38mm
- 2 Adaptadores de Ø 50mm



AG010229

148.00€

Juego de machos y terrajas con 50 piezas

Composición:

- 22 Machos + M3x0,5; M3x0,6; M4x0,7; M4x0,75; M5x0,8; M5x0,9
- 22 Terrajas: M6x0,75; M6x1,0; M7x0,75; M7x1,0; M8x1,0; M8x1,25; M9x1,0; M9x1,25; M10x1,0; M10x1,25; M10x1,5; M11x1,5; M12x1,25; M12x1,5; M12x1,75 y 1/8NPT27

1 Giramachos M6 - M12

- 1 Giramachos en T para machos
- 1 Porta terrajas
- 1 Destornillador phillips
- 1 Medidor paso rosca
- 1 Punzón



AG10001SP-T

3.60€

Giramachos en T para machos



AG10001SP-D

7.70€

Porta terrajas



AG10001SP-W

8.50€

Giromachos

Medidas: M4 a M12



AG10002SC-W

6.00€

Giromachos

Medidas: M3 a M12



AH020002

24.30€

Protección de aleta con fijación magnética

Dimensiones: 1 050x650mm



AI010006

28.00€

Herramienta para bloquear poleas y ruedas dentadas



AI010009

24.50€

Herramienta para la limpieza de las ranuras de los segmentos

Con 3 cuchillas circulares para limpieza de pistón (diámetro: 51 a 127mm)

Cuchilla 1: 1/16"; 5/64"; 3/32"; 1/8"; 5/32" y 3/16"

Cuchilla 2: 2; 2,5; 3; 4; 4,5mm y 1/4"

Cuchilla 3: 1,2; 1,5; 1,8; 2,8; 5 y 5,5mm



AI010017

150.00€

Regla de verificación de deformación del motor



AI010023

14.20€

Tensor de correas del motor



AI010029

75.00€

Extractor de engranajes y poleas



AI010030

95.00€

Llave para bloquear polea y árbol de levas



AI010037

97.00€

Kit calado de motores con 8 piezas

Composición:

Marca	Modelo	Aplicación
OPEL	Astra	G 1.7 TD; 2.0 16V
	Vectra	1.8; 2.0 16V >1995
OPEL	Astra	G 1.4 ; 1.6; 1.8 16V
	Vectra	1.6; 1.8 16V
	Zafira	1.6; 1.8 16V
Árbol de levas a la derecha		
SAAB	900 - 9000	
OPEL	Calibra	2.5; 2.5L; 2.6 V6
	Cavalier	2.5L V6 2.5; 2.5L; 2.6 V6
	Omega-B	2.5; 2.6; 3.0; 3.2; V6
	Sintra	3.0 V6
	Vectra	2.5L; 2.6 V6
Árbol de levas a la izquierda		
SAAB	900 - 9000	
OPEL	Calibra	2.5; 2.5L; 2.6 V6
	Cavalier	2.5L V6 2.5; 2.5L; 2.6 V6
	Omega-B	2.5; 2.6; 3.0; 3.2; V6
	Sintra	3.0 V6
	Vectra	2.5L; 2.6 V6
ROVER	25	1.4; 1.6; 1.8 VVC
	45	1.4; 1.6; 1.8
	75	1.8
	200	VI
	214	16V
	216	16V; Cabrio; Coupé
	218	Coupé
	414	16V
	416	16V; BRM 1.8 VVC
	VOLKSWAGEN	Bora
Golf		1.9 TDI
Lupo		1.2; 1.4; 3.0 TDI
Polo		1.4 TDI
Passat		1.9 TFI
CITROËN	Berlingo	1.9 D
	Jumper	1.9 D; TD-FSO 1.9D;
	Jumpy	1.9 D/TD
	Synergie	1.9; 2.0 T
	Xantia	1.9; 2.0 D; TD; HDI
	Xsara	1.9; 2.0 D; TD; HDI
FIAT	Ducato	2.0 D
	Ulysse	1.8; 2.0 Turbo
FORD	La mayoría de los motores diesel	
PEUGEOT	205	1.6; 1.8; 1.9 D
	305	1.6; 1.8; 1.9 D
	306	1.8; 1.9 D; TD
	309	1.6; 1.9 D
	405	1.6; 1.9 D
	406	1.9 D
	605	2.0 D; TD
	806	1.9 D
	Boxer	1.9; 2.0 D; TD
	Expert	1.9 D
	Partner	1.9 D
TALBOT	Express	D
	Horizon	D-J5D
	Solara	D
ISUZU	Motores Diesel	1.5; 1.7
OPEL	Motores Diesel	1.6; 1.7
	Motores Gasolina	1.2; 1.4; 1.6; 1.8; 2.0



AI010041

113.00€

Kit calado de motores con 19 piezas

Composición:

Marca	Modelo	Motorización
CITROËN	Synergie	2.0/Turbo; ZX 1.9D/TD
	Xantia	1.9D/TD
	Berlingo	1.9D
FIAT	Ulisses	2.0/Turbo
	Ducato	2.0
FORD	Fiesta	1.25; 1.4 (95-); 1.8-XR2i/RS1800 16V
	Mondeo	1.6; 1.8; 2.0 16V (93-)
	Escort/Orion	1.6; 1.8i 16V (92-)
HONDA	Accord/Prelude	2.3i (93-);
	Prelude	2.2 V-Tec; motor SOHC
	Accord	1.8; 2.0; 2.2 (-93); 2.0i (93-)
	Shuttle	2.2i;
	Civic	1.6 VTI
	Accord	(90-)
LAND ROVER	Discovery MPI	2.0 16V (-90)
	Discovery MPI	2.0 16V (93-); motor 20T4
MAZDA	121	1.25
OPEL	Cavalier	2.5
	Calibra	2.5
	Vectra	2.5
	Omega	2.5; 3.0
	Sintra	3.0
	Astra	1.8; 2.0 16V
	Cavalier	2.0 16V
	Calibra	2.0 16V/Turbo
	Omega-B	1.6 16V
	Motor Gasolina OHC	1.2; 1.4; 1.6; 1.8; 2.0
	Motor Diesel OHC	1.6D i; 1.7D
	Motor Diesel OHC	1.5D i; 1.7D
	Diesel Isuzu	1.5D i; 1.7D
	PEUGEOT	205; 305; 309; 405
405		1.8; 2.0 (92-)
605		2.0
Boxer		2.0
205; 305		1.8; 1.9D
306		1.8; 1.9D/TD
309		1.8; 1.9D; 1.8TD
405		1.8TD; 1.9D
406		1.9D
Partner		1.9D
Talbot/Horizon/Solara		1.9D
J5/Talbot Express		1.9D
605		1.9D/TD
806		1.9TD
Expert		1.9D
Boxer		1.9D/TD
RENAULT		R5
	R9	1.6D
	411	1.6D
	Express/Extra	1.6D - motores Diesel F8M
	Clio; Express/Extra	1.6D - motores Diesel F8Q
	R19	1.9D - motor diesel F8Q
	Espace	2.1D
	R21	2.1D
	R25	2.1D
	Trafic/Master	2.1D - motor Diesel J8S
	Clio	1.2; 1.4
	Express/Extra	R19 1.4
	Megane/Scenic	1.4; 1.6 - motor E7F/E7J
	R5	1.7
	Clio	1.7; 1.8
	R19	1.7
	R21	1.7
	Megane/Scenic	2.0
	Laguna	1.8; 2.0
Trafic	1.7 - motor F3N; F3P; F2R	
Clio Williams; R19; Megane	2.0 16V - motor F7P; F7R;	
Laguna/Safrane	2.0 16V - motor N7Q/N7U	
ROVER	623	(93-)
	618/620	motor SOHC (93-)
	216; 416	GTi 16V (-95) motor D16A9, motor K16 DOHC; motor SOHC 820.8V (m8)
	Metro	GTa/GTi 16V K16 (-95)
	214; 414	K16(89-)
	216; 416	K16 (95-)
	MGF	1.8 MPI/VVC (95-)
	220	M16 (-92)
	220	Turbo T16 (92-)
	420	M16 (-92)
	420	T16 (92-)
320	Turbo M16 (-91)	
620	Ti (94-)	
820	Turbo T16 Vitesse (91-)	
SAAB	900	2.5
	9000	3.0 V6
		TDI desde 2000
VW; AUDI; SEAT; SKODA		ECOTEC 1.4; 1.6; 1.8; 2.0 16V



AI010060
65.00€
Juego de 4 llaves para inyectores 1/2"

Composición:

	Faces	Diámetro (mm)	Medida (mm)
A	6	22	110
B	12	22	75
C	12	27	78
D	12	28	78

AI010060-A
18.50€
Llaves para inyectores 1/2"

Caras: 6

Diámetro: 22mm

Medida: 110mm

AI010060-B
16.70€
Llaves para inyectores 1/2"

Caras: 12

Diámetro: 22mm

Medida: 75mm

AI010060-C
15.30€
Llaves para inyectores 1/2"

Caras: 12

Diámetro: 27mm

Medida: 78mm

AI010060-D
15.40€
Llaves para inyectores 1/2"

Caras: 12

Diámetro: 28mm

Medida: 78mm

AI010063A
55.00€
Medidor de la tensión de correas distribución

AI010086
138.00€
Juego de 12 llaves para terminales

AI010092
78.00€
Bloqueo para el volante del motor

AI010104
36.80€
Herramienta para quitar la tapa del depósito combustible

Ajustable entre 122-199mm

AI010127
4.80€
Llave extractora de correa trapezoidal

Aplicación: VOLVO y grupo VAG

AI010137
43.50€
Organizador de piezas desmontadas

AI010090A
87.00€
Juego de llaves alternador

AI010166
9.20€
Llave torx para polea alternador 1/2"

Medida: T50

Longitud: 110mm

AI010167
9.30€
Llave XZN para polea alternador 1/2"

Medida: M10

Longitud: 110mm



AI010176 40.50€

Llave para quitar el filtro de combustible

Esta herramienta hace que sea rápido y fácil de realizar la reducción del riesgo de daños en la carcasa de plástico del filtro.

Composición:

Marca	Modelo	Aplicación
CHEVROLET	Captiva, Epica	2.0 VCDi
CITROËN	Hdi Relay	2.0; 2.2; 2.8; 3.0
FIAT	500; Doblo; Strada;	1.3 JTD
	Idea; Panda; Punto	
	Idea; Multipla; Punto;	1.9 JTD
	Sedici (+2.0 JTD)	
	Ducato	2.0; 2.2; 2.3; 2.8; 3.0 JTD
LANCIA	Musa; Ypsilon	1.3 MJTD
OPEL	Agila; Astra; Corsa;	1.3 CDTi
	Combo; Meriva; Tigra	
	Astra; Signum; Vectra;	1.9 CDTi
	Zafira	
PEUGEOT	Boxer	2.0; 2.2; 2.8; 3.0 HDI
SAAB	9-3	1.9 TiD
SUZUKI	Splash; Swift; SX4	1.3 DDiS



AI010195 113.00€

Llave para tensar correas con 10 piezas



AI020015 24.50€

Extractor para válvulas

Capacidad: 60-120mm
Altura: 150mm



AI0200



Alicate para segmentos

Ref.	Capacidad (mm)	Precio
AI020019	115-180	26.50€
AI020020	70-108	22.50€
AI020021	50-100	20.50€



AI020024 85.00€

Extractor para válvulas

Para grandes motores/ diesel



AI020025 71.00€

Extractor para válvulas

Capacidad: 55-175mm



AI020027 33.30€

Desarmador de válvulas universal con gancho

Compresor del muelle de válvulas



AI020047 23.00€

Extractor juntas de las válvulas



AI020048

Cinta para segmentos

Ref.	Capacidad (mm)	Altura (mm)	Precio
AI020048A	57-125	127	15.50€
AI020048D	90-175	100	17.00€
AI020048E	90-175	165	28.50€



AI020043 20.50€

Alicate para fuelles de mordazas



AI020049 78.00€

Alicate universal para válvulas



AI020051 225.00€

Kit prueba de compresión de aceite en motores de diesel

BMW, CITROËN, DACIA, DAF, DAIHATSU, FIAT, FORD, ISUZU, LAND ROVER, MAZDA, MERCEDES, MITSUBISHI; NISSAN, OPEL, PEUGEOT, RENAULT, ROVER, SEAT, TOYOTA, VOLKSWAGEN, VOLVO

Manómetro: 0-70bar

Diámetro: 80mm

Turbo: 400mm

Adaptadores:

M10x1 (73,5mm); M10x1 (114,5mm);

M10x1 (119mm); M12x1,25 (54mm);

M14x1,25 (72mm) y M20x1,5 (78mm)

Simulador Cuadrado 19 y 21mm



AI020052

160.00€

Kit prueba de compresión en motores de gasolina

Incluye adaptadores y reparadores con rosca

Medidas: M10; M12; M14 y M18



AI020054

165.00€

Kit prueba de presión de aceite

Incluye adaptadores y reparadores con rosca

Manómetro: 0-10bar/80mm

Turbo: 1 300mm

Juego de 10 adaptadores



AI020056A

24.00€

Alicate para retenes de las válvulas



AI020066

77.50€

Kit tenaza para segmentos con cinta

Apertura: 73-111mm



AI020092

78.50€

Extractor de tornillos dañados

Juego de brocas/ extractor y guías para la remoción de tornillos dañados

Gama: 5 a 16mm



AI020101A

135.00€

Dispositivo de comprobación de inyectores common rail diesel

Este dispositivo permite medir de forma rápida y eficiente la cantidad de combustible de retorno de cada inyector, y por tanto verificar, si hay algún fallo. Permite la medición de hasta 6 inyectores al mismo tiempo.

Incluye adaptadores para inyectores Bosch, Delphi, Denso y Siemens.



AI020101A-A

49.50€

Juego de vasos de recambio para AI020101A



AI020103

58.00€

Extractor de inercia para desmontaje de inyectores.

Hecho de acero endurecido de alta calidad.

Desmontaje rápido y fácil de inyectores presos en motores diesel.

Preparado para rosca M8; M12 y M14



AI020107

167.00€

Herramienta de ajuste del punto de inyección

Permite el ajuste del punto de inyección en motores diesel con bomba de inyección de combustible convencional.

Aplicable entre otros vehículos ALFA ROMEO, AUDI, BMW, FIAT, FORD, ISUZU, IVECO, LANCIA, LAND ROVER, MITSUBISHI, NISSAN, RENAULT, ROVER Y VOLKSWAGEN.



AI020109

78.00€

Juego de 6 llaves para calentadores

Composición/ medidas (mm):
Llaves: 8; 9; 10; 12; 14 y 16
Longitud: 160mm



AI020131

126.00€

Compresor de grapas de válvulas

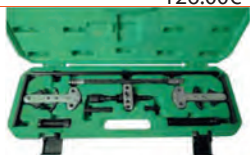

AI020142

385.00€

Extractor para rodamientos pequeños

Composición/ medidas (mm):
Extractor
Barra
Expansores: 6 a 8; 8 a 10; 12 a 15 y 15 a 18



AI020162

23.50€

Alicate de puntas rectas para quitar relés



AI020163

23.00€

Alicate de puntas angulares para quitar relés



AI020178

338.00€

Kit para extraer calentadores dañados



AI020180

125.00€

Test de sistemas turbo

Este kit por la insuflación de aire comprimido de baja presión en el sistema del turbo, permite la verificación de fugas.

Composición: 4 pares de adaptadores

Ø	Medida (mm)
55-60	64
65-70	74
75-80	84
85-90	94



AI020184

15.00€

Llave para inyectores MERCEDES BENZ

Cuadrado: 1/2"
Medida: 17mm
Longitud: 119mm



AI020184A

14.50€

Llave para inyectores BMW y VOLKSWAGEN

Cuadrado: 1/2"
Medida: 14mm
Longitud: 119mm



AI020184B

15.00€

Llave para inyectores MERCEDES BENZ

Cuadrado: 1/2"
Medida: 19mm
Longitud: 119mm



AI020184S

40.00€

Juego de 3 llaves 1/2 "para la línea de inyección

Composición:

Ref.	Medida (mm)	Aplicación
AI020184A	14	BMW; VW
AI0200184	17	Mercedes 100, 130, 314, 360, 360h, 352A, 346/355, 401, 402, 403, 407h, 615, 616 e 617
AI0200184B	19	Mercedes 314, 352, A, 346/355, A, 401, 402/422, LA, 403, 407



AI020185

18.50€

Llave estrella abierta plegada

llave especial para desmontar las tuberías del sistema de combustible de alta presión en los motores diesel
Medidas: 17x17mm



AI020201

67.00€

Juego de 6 llaves de vaso con estrella abierta

Especialmente diseñadas para trabajar en espacios apaciguados y de difícil acceso.

Cuadradillo: 1/2"

Longitud: 100mm

Medidas: 12; 14; 16; 17; 18 y 19mm



AI020205

128.00€

Extractor de inyectores (diesel/ gasolina)

Extractor especialmente concebido para la retirada de inyectores diesel y gasolina. Las garras son intercambiables lo que permite abarcar un mayor número de tipo de inyectores.



AI030007

18.50€

Juego de 5 piezas para raspar, limpiar y quitar juntas



AI050043S

21.50€

Juego de 3 raspadores

Medidas: 15; 20 y 30mm



AI030010

4.40€

Herramienta para pulir válvulas grandes



AI030011

4.00€

Herramienta para pulir válvulas pequeñas



AI030020

19.70€

Estetoscopio de mecánico



AI030025

6.50€

Juego de piezas rascar/quitar retenes y juntas



AI030027

42.50€

Juego de 6 rascadores con mango



AI040007

12.70€

Alicate para segmentos

Medidas: 1,2 a 6,3mm



AI040008

101.00€

Kit completo para prueba de vacío y purga de frenos



AI040031

145.00€

Bomba para vacío y presión con kit de purga de frenos

Selección de la válvula de control para la función de vacío o presión.



AI040005

18.00€

Alicate de puntas curvas para anillos de seguridad



AI040006 18.00€

Alicate de puntas retas para anillos de seguridad



AI040011 15.80€

Alicate de bujías con puntas aisladas



AI040017 58.50€

Juego de alicates para clips de cabezas recambiables

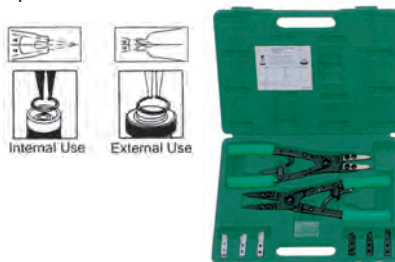

AI040018 21.50€

Alicate para abrazaderas



AI010201 91.00€

Llave flexible para tubos de combustible

Le permite trabajar en espacios reducidos.



AI040060 28.60€

Alicate para tubos de combustible

Alicate para conexiones rápidas de tubos de combustible.



AI040246 43.00€

Juego para desconectar tubos de combustible

Composición:

- 1 Llave fija para tubos 11,8mm
- 1 Llave fija para tubos 16mm
- 1 Llave angular para tubos 11,8mm
- 1 Llave angular para tubos 16mm



AI030002 29.00€

Juego de 11 llaves para tapones de aceite

Cuadrado: 3/4"

Utilización: llave de vaso 19mm

Hexagonales

8mm: BMW/ FORD/ GM

9mm: GM

10mm: FORD

12mm: FIAT/ LANCIA/ PEUGEOT/

14mm: LANCIA/ MERCEDES

17mm: AUDI/ BMW/ DAC

Cuadradas + cable

8mm: PSA/ RENAULT/ VOLVO

9,5mm: HONDA/ MAZDA/ PEUGEOT/ SAAB/ VOLVO

11mm: FORD

13mm: NISSAN/ SUBARU



AI050004 59.70€

Juego de 15 piezas de copa para filtros

Composición:

Caras	Medidas (mm)	Aplicación
14	65	GM, DAIHATSU, TOYOTA
14	65-67	DAIHATSU
14	68	MAZDA, FORD ESCORT, SUBARU
14	73	TOYOTA, LEXUS
15	74-76	SATURN
15	75-77	VW, AUDI, FORD, ISUZU, MERCEDES, OPEL
14	76	VW, PORSCHE, MERCEDES, BMW, AUDI A3, OPEL
30	76	FORD
15	80	NISSAN, HONDA, MAZDA, ISUZU, SUBARU, OPEL, TOYOTA
15	80-82	MAZDA, SUBARU, TOYOTA, HONDA, ACURA, NISSAN HONDA ACCORD, MITSUBISHI, ISUZU
15	93	OPEL, MAZDA, VOLVO, MITSUBISHI, NISSAN, VW, PORSCHE, RENAULT, FORD, HONDA, AUDI
36	93	FORD
15	100	ISUZU, MITSUBISHI

Adaptador 1/2" (F)x3/8" (M)



HC
Llaves de copa para filtros

Ref.	Caras (mm)	Medida (mm)	Precio
HC-78/15	15	78	4.90€
HC-65/67	14	65-67	4.70€
HC-65/14	14	65	5.40€
HC-68/14	14	68	4.80€
HC-74/15	15	74	5.00€
HC-66/6	6	66	4.80€
HC-76/8	8	76	4.90€
HC-73/14	14	73	5.00€
HC-74/76	15	74-76	5.20€
HC-75/77	15	75-77	5.20€
HC-76/12	12	76	5.00€
HC-76/30	30	76	5.00€
HC-93/36	36	93	5.00€
HC-76/14	14	76	5.00€
HC-108/15	15	108	4.70€
HC-108/18	18	108	5.00€
HC-65103		65-120	17.00€
HC-106/15	15	106	5.40€
HC-100/15	15	100	5.10€
HC-86/16	16	86	5.10€
HC-90/15	15	90	5.10€
HC-80/82	15	80-82	4.70€
HC-92/10	10	92	5.10€
HC-93/45	45	93	5.10€
HC-93/15	15	93	5.10€
HC-86/18	18	86	5.00€
HC-80/15	15	80	5.00€
HC-96/18	18	96	5.00€
HC-95/15	15	95	5.20€
HC-9.5mm	adaptadores 1/2"-3/8"		2.00€

AI050004A
140.00€
Juego de 30 piezas de copa para filtros

Composición:

Caras	Medida (mm)	Aplicação
14	65	GM, DAIHATSU, TOYOTA
14	65-67	DAIHATSU
14	68	MAZDA, FORD ESCORT, SUBARU
14	73	TOYOTA, LEXUS
15	74	AUDI, GM, ROVER, CHRYSLER
15	74-76	SATURN
15	75-77	VW, AUDI, FORD, ISUZU, MERCEDES, OPEL
8	76	FIAT MAREA, LANCIA DELTA
12	76	FIAT (DUCATO, SCUDDO, ULYSSE), RENAULT (MEGANE, LAGUNA, ESPACE)
14	76	VW, PORSCHE, MERCEDES, BMW, AUDI A3, OPEL
30	76	FORD
15	78	NISSAN, FORD, TOYOTA
15	80	NISSAN, HONDA, MAZDA, ISUZU, SUBARU, OPEL, TOYOTA
15	80-82	MAZDA, SUBARU, TOYOTA, HONDA, ACURA, NISSAN
16	86	Volvo (S40, S60, S70, S80)
18	86	VW (GOLF TDI, PASSAT/TDI), AUDI A6 TDI, RENAULT (CLIO, RAPID 1.9D, LAGUNA, SAFRANE, ESPACE 2.1D, CITROEN; PEUGEOT
15	90	HONDA ACCORD, MITSUBISHI, ISUZU
10	92	FIAT (CINQUECENTO, COUPE, CROMA, PANDA, REGATA, RITMO, SEICENTO, TEMPRA, TIPO), LANCIA (BETA, DEDRA, KAPPA, THEMA)
15	93	OPEL, MAZDA, VOLVO, MITSUBISHI, NISSAN, VW, PORSCHE, RENAULT, FORD, HONDA, AUDI
36	93	FORD
45	93	VW AUDI (2.4; 2.6; 2.8L)
15	95	TOYOTA, ALFA, GM, FORD, CHRYSLER
18	96	AUDI (A4, A6TDI), VW (PASSAT 97 TDI), RENAULT (LAGUNA 2.2D, SAFRANE 2.2D, ESPACE 2.2D, R19, RAPID, MEGANE 1.9/2.1D)
15	100	ISUZU, MITSUBISHI
15	106	FIAT DUCATO 2.5 TD
18	108	RENAULT (ESPACE, LAGUNA, MASTER, SAFRANE, TRAFFIC 2.4; 2.5; 2.8D)

 Llave filtro de aceite ajustable 65-120
 Adaptador 1/2"(F)x3/8"(M)

AI050009A
8.80€
Llave de filtros de aceite

AI050022

11.30€

Llave de filtros de aceite

Ajustable: 60-90mm



AI050024

22.00€

Juego de 4 palancas

Medidas: 200; 330; 540 y 600mm



AI050001

19.70€

Llave de filtros de aceite de 3 brazos

Capacidad: 60-120mm



AI050037

19.50€

Llave de filtros de 3 patas

Capacidad: 45-110mm



AI030067

42.90€

Juego de 17 llaves para tapzon cárter 3/8"

Composición:

6 Llaves 6 caras: 8; 9; 10; 11; 12; 13 y 14mm

9 Llaves cuadradas: 7; 8; 10; 11; 12; 13 e 14mm 5/16" y 3/8"

1 Llave cuadrada (hembra): 10mm

1 Llave triangular



AI050040

11.30€

Llave para tapón

Medidas: 8 y 10mm



AI050175

18.00€

Llave para Retirar/Instalar la carcasa plástica de los filtros de aceite

Aplicación: Motores TDCI - HDI - Ford, Peugeot, Citroën



AN01009A

7.20€

Llave para cárter multiple

Medidas (mm): 10; 11; 12; 13; 14; 15 y 17mm

Longitud: 150mm



AN010030

13.50€

Alicata para quitar pesos de la rueda



AI050042

17.70€

Llave para cambio de ventiladores

Medidas: 8 y 10 mm



AI050043

19.90€

Alicata de presión para filtros de aceite

Medida: 53-118mm



AI050076

59.50€

Llave de filtros ajustable 1/2"

Medida: 60-80mm



AI050077

18.00€

Llave de correa para filtros

Medida: 25-160mm



AI050080

10.00€

Llave para tornillos de culata del motor 1/2"

Medida: M9

Longitud: 100mm



AI05009
Llave de bujías larga 3/8"

Ref.	Medida (mm)	Longitud (mm)	Precio
AI050092	14	250	15.00€
AI050093	16	250	17.40€

AI050096S
55.50€
Juego de 7 llaves especiales

 Sensores de vacío y de oxígeno
 Válvulas de presión estática

AI050102
80.00€
Llave de filtros 3 brazos auto ajustable

Capacidad: 95-165mm

AI050202
9.50€
Llave de vaso para filtros de 14 caras 3/8" con 54mm

Marca	Modelo	Motorización
TOYOTA	Auris/ Corolla/ Prius	1.8/ 2.0 4 cilindros

AI010033
7.30€
Llave para sensor de oxígeno

AI050104
21.80€
Llave para sondas de oxígeno

Medida: 22mm

AI050109
49.50€
Llave magnética para tapón

 Longitud: 350mm
 Filtros: 60 a 105mm

AI050113
194.00€
Juego de puntas impacto de 3/4" y 1"

 Composición/ medidas (mm):
 5 Llaves torx T60, T70, T80, T90 y T100 (107mm)
 4 Llaves hexagonales 17, 19, 22 y 24mm (107mm)
 4 Llaves torx E18, E20, E22 y E24 (107mm)
 1 Llave 6 caras 3/4" 22mm
 1 Llave 6 caras 1" 22mm
 1 Llave hexagonal en L 4mm

AI050152
20.00€
Tubo para descarga de aceite usado en el alojamiento del filtro

AI050152A
12.80€
Tubo para descarga de aceite usado en el alojamiento del filtro

Aplicación: TOYOTA y LEXUS

AI050176
199.00€
Kit para montaje de correas acanaladas con 11 piezas

Composición:

Marca	Modelo
AUDI	A3
BMW	118/ 120/ 318/ 325/ 330/ 335/ 520/ 525/ 530/ 535/ 635/ 720/ 730/ X3/ X5
CITROËN	C2/ C3/ C4/ Jumper/ Relay
CHRYSLER	Grand Voyager/ Voyager
FIAT	Albea/ Doblo/ Ducato/ Fiorino/ Marea/ Multipla/ Qubo/ Linea/ Palio/ Siena/ Stilo y Strada
FORD	C-Max/ Courier/ Fiesta/ Focus C-Max/ Fusion/ Mondeo/ Tourneo/ Transit
IVECO	Daily
LANCIA	Lybra
MAZDA	2/ 3/ 5/ Axela
MERCEDES	Sprinter/ Viano/ Vito
MITSUBISHI	ASX
PEUGEOT	206/ 207/ 307/ Boxer
SEAT	Altea/ Ibiza
SKODA	Octavia/ Yeti
VOLKSWAGEN	EOS/ Golf/ Passat/ Polo/ Sirocco
VOLVO	C30/ S40/ V50



AL010093 31.00€

Herramienta para montaje/ desmontaje de correas elásticas poli-v



AI050191 12.70€

Llave magnética para los enchufes



AE300180 47.00€

Embudo para líquido refrigerante

Dimensiones: 160x160x260mm
Embudoz + 2 adaptadores



AE300179-02 41.00€

Adaptadores para embudo líquido refrigerante AE300180



AE300179-03 41.00€

Juego de 6 adaptadores para embudo líquido refrigerante AE300180

Vehículos europeos



AE300221

Adaptadores para líquido refrigerante

Ref.	Aplicación	Precio
AE300221-02	Vehículos Japoneses	15.50€
AE300221-03	Honda, Toyota	22.00€
AE300221-04	Ford, Mazda, Mitsubishi, Nissan	16.00€



AI050192 38.50€

Embudo universal para aceite

Presilla de fijación embudo: 28-74mm



AI060006 8.60€

Reparación de "roscas" alojamiento de bujías

Medida: 14mm



AI060020 3.80€

Calibre de espesores (galgas) con 20 láminas

Medidas (mm): 0,05; 0,10; 0,15; 0,20; 0,25; 0,30; 0,35; 0,40; 0,45; 0,50; 0,55; 0,60; 0,65; 0,70; 0,75; 0,80; 0,85; 0,90; 0,95 y 1

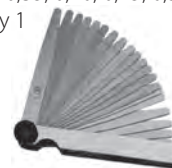

AI060030 185.00€

Kit de reparación de las roscas de alojamiento de bujías con 56 piezas



AI060030

Helicoides

Ref.	Medida	Cuadradillo	Cantid.	Precio
AI060030-A	M10x1,0	3/8	10	6.90€
AI060030-B	M12x1,25	3/4	10	13.50€
AI060030-C	M14x1,25	7/16	10	16.80€

AI060030
Macho

Ref.	Medida	Cantid.	Precio
AI060030-D	M10x1,0	1	11.50€
AI060030-E	M12x1,25	1	14.50€
AI060030-F	M14x1,25	1	20.70€

AI060031
135.00€
Kit reparador de roscas con 87 piezas

Composición: Medidas:
 Helicoides: 25x M6x1.0x1.5 (9mm)
 25x M8x1.25x1.5 (12mm)
 25x M10x1.5x1.5 (15mm)

Macho: M6x1.0
 M8x1.25
 M10x1.5

Punzón: M6x1.0
 M8x1.25
 M10x1.5

Broca: 6,3mm
 8,3mm
 10,4mm

Mango: M6x1.0
 M8x1.25
 M10x1.5

AI060031
Helicoides

Ref.	Medida	Cantid.	Precio
AI060031-A	M6x1,0	10	5.20€
AI060031-B	M8x1,25	10	6.40€
AI060031-C	M10x1,5	10	8.20€

AI060031
Macho

Ref.	Medida	Cantid.	Precio
AI060031-D	M6x1,0	1	6.90€
AI060031-E	M8x1,25	1	9.20€

AI060031
Broca

Ref.	Medida (mm)	Cantid.	Precio
AI060031-G	6,6	1	4.80€
AI060031-H	8,3	1	8.30€
AI060031-J	10,4	1	12.00€

AL010006
32.50€
Juego de 3 alicates

Para conexiones rápidas de tuberías de combustible

AL010011
23.20€
Llave para tuercas suspensión (copelas)

AL010073
174.00€
Kit para desmontaje de las cabezas de amortiguadores

Aplicación: BMW, Fiat, Honda, Mercedes, Mitsubishi, Nissan, Opel, Peugeot, Renault, Suzuki, Toyota y Volvo

AN010001
51.00€
Kit de herramienta para frenos neumático con 11 piezas

Para sangrar y girar los pistones de freno

AN010001C
64.00€
Kit de herramienta para frenos neumático con 18 piezas

Para sangrar y girar los pistones de freno



AN010001D

180.00€

Kit de herramienta para frenos neumático
Para sangrar y girar los pistones de freno



AN010001D

Adaptadores

Ref.	Marca	Precio
AN010001D-2	Citroën, Honda	6.80€
AN010001D-3	Varios	7.20€
AN010001D-4	Varios	4.70€
AN010001D-5	Adaptador 3/8"	6.20€
AN010001D-6	Nissan, VW	4.60€
AN010001D-7	Varios	4.60€
AN010001D-A	Renault	4.60€
AN010001D-E	Nissan, Ford	4.60€
AN010001D-F	Opel	4.60€
AN010001D-K	Citroën	7.40€
AN010001D-M	Varios	4.60€
AN010001D-N	Ford, Mazda, Mini	4.60€



AN010293

35.70€

Llave especial para presionar las pinzas de freno

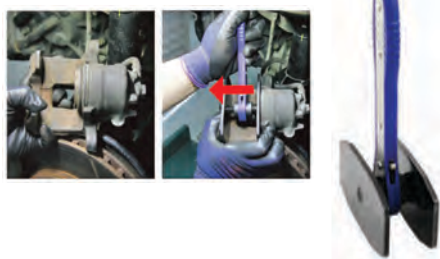

AN010102

15.00€

Alicate para comprimir muelle del freno de mano



AN010321

24.00€

Alicates cable freno de mano



AN010322

37.00€

Alicates para los muelles de los tambores de freno



AN010033

5.80€

Extractor de bujes



AN010085A

14.80€

Herramienta para colocar válvulas neumáticas



AN010038

7.70€

Extractor de retenes



AN010049

13.00€

Centrador de embrague universal



AN010063

68.00€

Alicate centrador de embrague universal



AN010065

67.00€

Juego de 4 pinzas para cilindros de freno



AN010081A

23.50€

Alicate de muelles de frenos



AN010160

20.00€

Herramienta de comprobación de la altura de las zapatas de freno



AN010066 46.00€

 Kit de desmontaje del embrague del compresor A/C
 Aplicable en diversas marcas de compresores A/C

AN010054A 22.50€

Juego de 3 alicates para tuberías de goma

AN010054N 23.50€

Alicata de presión para tuberías

AR060062 36.60€

 Alicata tensor para abrazaderas de tubos
 Amplitud: 5 a 55mm

AN010068 6.00€

Limpia bornes y terminales de batería

AN010072 30.00€

Reparación de roscas interno y externo

Medidas de las roscas: 0,8; 1; 1,25; 1,50; 1,75; 2 y 3mm



AN010072C 18.60€

Reparador de roscas SAE (pulgadas)

Medidas de las roscas: 9"; 10"; 16"; 20"; 27"; 28" y 32"

AN010091A 99.90€

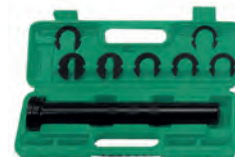
Extractor para rótula axial de dirección

AN010092 72.00€

Llave excéntrica para rótula axial de dirección

Medida: 33-42mm

AN040327 27.00€

Herramienta ajuste eje trasero MB

AI030075 27.70€

Alicata para tubos de escape

AN010106A 49.50€

Alicata corta tubos de escape

No se puede utilizar tubos de acero inoxidable

Medidas: 19 a 76mm de diámetro

AN010106A-C 28.00€

Cadena de corte para cortar tubos de escape

AN010112 20.50€

Adaptador para desmontaje de semi ejes

AN010131 18.30€

Rodillo prensador para neumáticos



AN010137 81.50€

Alicate para tapones de bujes de ruedas



AN010186B 625.00€

Kit para embrague auto ajustable y bimasa



AN010188

Palanca para desmontaje de ruedas



Ref.	Medida (mm)	Precio
AN010188A	500	23.00€
AN010188B	350	11.00€
AN010188C	200	4.70€

AN010225 595.00€

Herramienta para instalar/ quitar rodamiento manga eje

Permite profesionalidad, rapidez, seguridad y poco esfuerzo en la tarea

Aplicación: PEUGEOT, CITROËN y RENAULT



AN010226 18.20€

Medidor de espesor de los discos de freno y profundidad base neumáticos

Discos de freno: 0-60mm

Material: aluminio



AN010319 122.00€

Medidor digital de espesor de discos de freno y profundidad de espesor neumáticos

Capacidad de medición: 0-100mm



AN010320 77.00€

Medidor de discos de freno



AG010205 20.00€

Medidor digital de profundidad

Utilizado para medir la profundidad del suelo de los neumáticos y de las pastillas de freno.

Especificaciones:

Gama de medición: 0-25,4mm

Resolución: 0,01mm

Display: LCD

Medición en milímetros o pulgadas.

Utiliza pilas SR44/ LR44 de 1,4V (no incluidas).



AN010272 14.50€

Alicate para tapas plásticas hembras de la rueda

Permite retirar as tapas plásticas de las hembras de la rueda sin dañar las llantas.



AN010279 365.00€

Mecanismo para desbloqueo de rueda MB/ BMW

Aplicación

Mercedes Benz: W164 (Clase GL); W197 (SLS); W204 (Clase C); W212 (Clase E); W221 (Clase S) e W251 (CLR)

BMW: F01/F02 (Série 7); F07/F10 (Série 5);

F12/F13 (Série 6); F25 (x3) y

F30/ F31/ F32/ F33/ F34 (Séries 3 y 4)



AN020007 30.00€

Pulidora de cilindros

Medida: 51-177mm



AN020007-1 12.70€

Juego de 3 piedras para pulidora de cilindros

Aplicable a despolidor AN020007

AN020022
31.00€
Juego de pulidora de cilindros

Composición/ medidas (mm):

Medida: 18-89

Piedras: 19; 28,8 y 51

Juego de piedras de reemplazo

AN020022
Juego de piedras para pulidora de cilindros

Ref.	Medida (mm)	Unidades	Precio
AN020022-A	51	3	8.60€
AN020022-B	28,8	2	6.20€
AN020022-C	19	3	5.80€
AN020022-D	28,8	2	5.50€

AN040035A
17.90€
Corta tubos

AN040043A
60.00€
Juego de cortar tubos y abocardador

Composición/ medidas (mm):

Fijador de tubos: 4; 6; 8; 10; 12; 15 y 16

Punzones abocardador: 4; 6; 8; 10 y 12

AN040082
127.00€
Juego quita tuercas dañadas con 9 piezas 3/8"

Medidas: 10; 11; 12; 13; 14; 15; 16; 17 y 19

AN040101
7.80€
Punta 1/2" pentagonal para frenos

AN040168
440.00€
Juego de herramienta para instalar/ quitar rodamientos de rueda

Permite profesionalidad, rapidez, seguridad y poco esfuerzo en la tarea

Para rodamientos: 60 a 85mm

AR020018
24.00€
Comprobador de presión

Manguera flexible con adaptador: 14 y 18mm

Escalas: 0-300psi; 21kg/cm²; 21 bar y 2 100kpa

AR020019
24.00€
Comprobador vacío y bomba combustible

AR020053A
240.00€
Kit de accesorios eléctricos/ electrónicos auto

AR030013
4.30€
Hidrómetro para baterías líquidas

AR030034
6.50€
Punta pruebas circuitos entre 3-48V

Indicación de polaridad mediante Leds



AR030041

68.00€

Juego de 7 aplicadores de juntas

Composición/ medidas (mm):
14,4-16; 15,9-17,5; 17,5-19,1; 20,7-22,4;
24-26; 25,5-27,5 y 30,3-32,3



AR030047

25.00€

Test fluido de frenos
Batería no incluida.



AR030062

41.50€

Test de actuadores

Este equipo permite la prueba a componentes electrónicos que actúen por campos magnéticos y electromagnéticos.



AR040043

17.00€

Extractor terminales de los cables de la batería
y limpia parabrisas



AR040016

82.00€

Juego de cables de arranque de la batería 500 Amp

Dimensiones: 0.3x268x12mm
Longitud: 3 600mm



AR060002A

25.50€

Alicate para abrazaderas - matriz "+"



AR060003

17.00€

Alicate para abrazaderas - matriz "V"



AR060008

17.80€

Alicate para abrazaderas de filtros combustible tubos de
evacuación



AR060038

20.00€

Alicate angular para abrazaderas de tubo



AR060039A

19.20€

Alicate para abrazaderas de tubo



AR060055

25.80€

Alicate de abrazaderas de tubos

Apertura de 22 a 55mm



AR060056

29.00€

Alicate para abrazaderas de tubo

Medida: 0-38mm



AR060010

23.30€

Alicate para tubos do radiador



AR060011

11.80€

Dispositivo para el bloqueo de tuberías



AR060020

14.50€

Alicate para quitar tubos



AR060021

49.50€

Alicate para abrazaderas VAG



AR060024A

175.00€

Kit de 7 alicates para abrazaderas



AN010177B

58.00€

Alicate especial para abrazaderas de fuelle



AR060029

54.00€

Montador de fuelles



AR060032

18.80€

Kit de adaptadores para desacoplamiento de tubos A/C



AR060043

120.00€

Juego de 52 piezas para extracción de radios

Aplicación:
 Marca Auto: AUDI; BMW; FIAT; FORD; SKODA;
 MERCEDES; OPEL; PORSCHE y VOLKSWAGEN
 Marca Radio: Becker; Blaupunkt; Clarion; JVC;
 Grundig; Kenwood; Panasonic; Pioneer y Sony



Herramienta - aplicación especial por MARCAS GRUPO BMW y MINI

AI010121

68.00€

Llave para boya de depósito de combustible

Aplicación: AUDI, BMW, MERCEDES, PORSCHE y VOLKSWAGEN

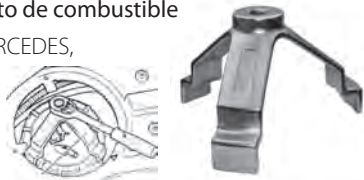

AI010139

122.00€

Herramienta desmantelador del sensor de nivel de combustible

Aplicación: BMW y MINI



AL010099

275.00€

Kit comando del motor diesel BMW

Modelo	Motorización
E34/ E36/ E38/ E39/ E46/	M41/ M51/ M47TU/ M47T2/
E53/ E60/ E61/ E63/ E65/	M57TU/ M57T2
E66/ E70/ E83/ E87/ E90/ E91/	
Land Rover	2.5DT/ 3.0TD6/
Freelander	2.0TD4



AL010128

59.50€

Kit comando del motor BMW

Modelo	Motorización	Ano
118d	E87	2003-2007
120d	E87	2003-2007
318d/td	E46 E90/91	2000-2008
320d/crd	E46 E90/91	1997-2008
325d	E90/91/92/93	2006-2010
330d/xd/crd	E46 E90/91/92/93	1998-2008
510d	E39 E60/61	1999-2010
525d/xd	E39 E60/61	1999-2010
530d/xd	E39 E60/61	1998-2010
535d	E60/61	2004-2010
635d	E63/64	2004-2010
730d	E38 E65/66	2003-2010
X3 2,0d	E83	2003-2007
X3 3,0d	E83	2003-2010
X5		



AI010115

29.70€

Extractor de bombas inyectoras BMW

Modelo	Motorización
318D/ 320D/TD/ 330D	E46
525D/ 530D	E39
525D/ 530D/ 535D	E60/E61
730D	E38
X5 3,0D	E53



AI020184A

14.50€

Llave para inyectores BMW y VOLKSWAGEN

Cuadrado: 1/2"
Medida: 14mm
Longitud: 119mm



AI050071S

347.00€

Juego de 8 llaves especiales BMW

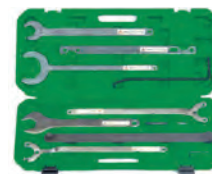

**Herramienta - aplicación especial por MARCAS
FIAT y OPEL**

AL010044

155.00€

Kit calado del motor FIAT/ OPEL

Marca	Modelo	Motorización	Año	Piezas nº
FIAT	Panda/ Idea/ Doblo	1.3JTD Multijet	2004-2007	7; 8; 9; 10
		1.7D/ 1.9D/ TD/ JTD2.4		1; 3; 4
		1.9/ 2.4JTD 16V/ 20V		2; 3; 4; 5; 6; 7
OPEL	Agila/ Corsa/ Astra H/ Tigra B/ Meriva/ Astra/ Vectra/ Signum/ Zafira	1.3CDTI	2004-2007	7; 8; 9; 10
		1.9CDTI		2; 3; 4; 5; 6; 7
ALFA ROMEO	147/ 156	1.9JTD 16V/ 2.4JTD 20V		2; 3; 4; 5; 6; 7



AL010196

55.00€

Kit calado del motor gasolina

Marca	Modelo	Motorización
ALFA ROMEO	159	939A4.000
CHEVROLET	Aveo/ Cruze/ Orlando	
FIAT	Croma	939A4.000
OPEL	Astra G/ Astra H/ Corsa D/ Meriva A/ Zafira B/C/ Vectra C/ Signum/ Insignia	Z16LEL/ Z16LER/ Z16LET/ Z16ZE1/ Z16XEP/ Z16ZER/ LLu/ A16LET/ A16XEL/ 2HO/A18XEL/ 2HO/A18XE R/Z18XER



**Herramienta - aplicación especial por MARCAS
FORD, MAZDA y VOLVO**

AL010070

26.00€

Kit calado del motor FORD/ PEUGEOT/ CITROËN

Marca	Modelo	Motorización
FORD	Fiesta/ Fusion Focus/ Focus C-Max Fusion/ Fiesta	1.4TDCI
		1.6TDCI
		1.6TDCI
CITROËN	C4	1.6HDI
PEUGEOT	206	1.4HDI
PEUGEOT	307	HDI



AL010071

81.00€

Kit calado del motor FORD

Modelo	Motorización	Año
Fiesta	1.8D Turbo	
Focus		
Focus C-Max	1.8TDCI	
Tourneo Connect	1.8TDDI/ TDCI	
Transit Connect	1.8TDDI/ TDCI	2002-2006



AL010107

80.00€

Kit calado del motor FORD

Modelo	Motorización diesel
Fiesta	1.8TDDI/ TDCI
Focus	Turbo
Transit	
Transit Connect	



AL010175

32.50€

Pin de fijación árbol de levas

Marca	Modelo	Motorización	Año
FORD	Fiesta/ Fusion	1.4TDCI	2002>2009
	Focus C-Max	1.4/ 1.6TDCI	
	Mondeo	2.0TDI/ TDCI/ 2.2TDCI	
	Transit	2.0TDI/ TDCI/ 2.4TDI/ TDCI	
		2.0TDI/ TDCI/ 2.4TDI/ TDCI	
VOLVO	S40/ V50	1.6D/ 1.9D	



Herramienta - aplicación especial por MARCAS FORD, MAZDA y VOLVO
AL010205
8.70€
Kit calado del motor FORD/ MAZDA/ VOLVO

Marca	Modelo	Motorización
FORD	C-Max/ Cougar/ Fiesta/ Focus	HWDA/ HWDB/ CSDA/ QQDA/ QQDB/ QQDC/ AODA/ AODB/ DBA/C/ EDBB/ EDBD/ F8JA/ F8JB/ FUJA/ FUJB/ M7JA/ M7JB/ FXJA/ FXJB/ FYJA/ FYJB/ N4JB/ FHA/ FHE/ L1T/ L1V/ ASDA/ ASDB/ FXDA/C/ FXDB/D/ FYDA/C/ FYDB/D/ EYDB
MAZDA	6	
VOLVO	C-30/ S40/ S80/ V50/ V70	B4164S3/ B4184S11/ B4204S3

AL010218
157.00€
Kit calado del motor FORD
Modelo:

Fiesta/ Fusion/ Focus/ C-Max/ B-Max/ S-Max/ Mondeo/ Galaxy

AN040286
350.00€
Extractor de silentblocks

Marca	Modelo	Año
FORD	Focus I	1998-2005
	Focus II	2004-2008
	CB4	2008-2011
MAZDA	3	2003-2008
	3	2009 ->
	5	2005-2010

Herramienta - aplicación especial por MARCAS HYUNDAI y KIA
AL010282
69.00€
Kit calado del motor HYUNDAI/ KIA
Aplicación:

HYUNDAI: Accent; Elantra; Getz; i10; i20; i30; i40; ix35; ix55; Matrix y Tucson.

KIA: Carens; Cee'd; Cerato; Optima; Picanto; Pro-Cee'd; Rio; Soul; Sportage y Venga.

Herramienta - aplicación especial por MARCAS MERCEDES
AG010204
10.00€
Llave de impacto para ruedas especial - MERCEDES 1/2" con 17mm
Aplicación:

MERCEDES: W204 (Clase c); W204(GLK); W207/ W211/ W212 (Clase E); W166 (Clase M); W221/ W222 (Clase S); W172 (SLK); W164/ W166 (ML) y W216 (CL) y Maybach.

AI010114
38.00€
Juego de herramientas para airbag

AI010097
18.80€
Llave hexagonal 1/2" especial para SCANIA y MERCEDES

Longitud: 27mm

AI010116
48.00€
Extractor de bujías de incandescencia

Motorización: 611/ 612/ 613

Longitud: 10mm



Herramienta - aplicación especial por MARCAS MERCEDES

AI020113 158.00€

Juego para extracción de inyectores common rail MB

Motorização:
OM 611/ OM 612/ OM 613



AI020184 15.00€

Llave para inyectores MERCEDES BENZ

Cuadrado: 1/2"
Medida: 17mm
Longitud: 119mm



AI020184B 15.00€

Llave para inyectores MERCEDES BENZ

Cuadrado: 1/2"
Medida: 19mm
Longitud: 119mm



AI020186 59.00€

Juego extractor de boquillas inyectores

Modelo	Motorización
Clase C/ Clase E/ Sprinter	108CDI/ 110CDI 16V/ 112CDI 16V/ C220CDI 16V/ E200CDI 16V



AI050071S 347.00€

Juego de 8 llaves especiales MB

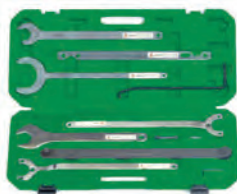

AI050085A 17.50€

Llave de filtros de 14 caras con 74mm

Nota: utilizando una llave con la caja de 27 mm, se debe aplicar una fuerza máxima de 25Nm. Si se aplican fuerzas superiores, se corre el riesgo de dañar la llave de filtros.

Marca:

MERCEDES/AUDI A3/ BMW E36/ CITROËN/
FIAT/ FORD/ LANCIA/ MAZDA/ NISSAN/
OPEL/ PEUGEOT/ PORSCHE/ RENAULT/
TOYOTA/ VOLKSWAGEN Golf IV



AI050200 82.00€

Juego de 4 varillas de aceite transmisión

Aplicación: Mercedes Benz



AL010057 148.00€

Llave bloqueador del cigüeñal MB



AN040126 225.00€

Herramienta para desmontaje de silentblocks eje trasero MB



Herramienta - aplicación especial por MARCAS GRUPO PSA - PEUGEOT/ CITROËN

AI010136 112.00€

Kit calado del motor HPI (gasolina) y HDI (diesel) PEUGEOT/ CITROËN

Marca	Modelo	Motorización	Año
PEUGEOT	206/ 307/ 406	1.8 16V	2000-2004
	607/ 806/ 807	2.0 16V	2002-2005
	Expert		
CITROËN	C4/ C5	1.8/ 2.0HPI	2002-2005
	Xsara	2.0 16V	2002-2005
	Xsara Picasso	1.8/ 2.0 16V	2002-2005
	Evasion/ C8 Jump		

Códigos motor: 6FZ (EW7J4)/ FRN (EW10J4/L4/5)/ RLZ (EW10D)



AL010175 32.50€

Pin de fijación árbol de levas

Marca	Modelo	Motorización
CITROËN	C1/ C2/ C3/ Xsara	1.4HDI
	C3/ C4	1.6HDI
PEUGEOT	107/ 206/ 207	HDI
	307	1.4/ 1.6HDI



**Herramienta - aplicación especial por MARCAS
GRUPO PSA - PEUGEOT/ CITROËN**
AN040100
8.30€
Vaso pentagonal para frenos PSA

Medida: 17mm

AL010041
177.00€
**Kit calado del motor HPI (gasolina) y HDI (diesel) PEUGEOT/
CITROËN**

Marca	Modelo	Motorización	Año	
CITROËN <i>Diesel</i>	Visa/ BX/ ZX/ Xantia/ Xsara/ Synergie/ C15/ Berlingo/ Dispatch/ C25/ Relay	1.7/ 1.8/ 1.9/ D/ TD	1984-2002	
	Saxo/ AX/ Xsara	1.5D	1994-2007	
	Xsara/ Berlingo/ Dispatch 1.9D		1998-2007	
	Xsara/ Xsara Picasso/ Xantia/ C5/ Synergie/			
	Berlingo/ Dispatch/ Relay 2.0HDI		1998-2007	
	C4	2.0HDI	2004-2008	
	C5	2.2HDI	2000-2004	
	C8	2.0/ 2.2/ HDI	2002-2007	
	Relay	2.5D/ TurboD	1994-2002	
	XM/ Xantia/ Dispatch/ Synergie/ Evasion	2.1D/ 2.2D/ TD	1994-2002	
	CITROËN <i>Gasolina</i>	AX/ Xsara/ AX GTi/ Saxo/ ZX/ Berlingo	1.0/ 1.1/ 1.4/ 1.6	1994-2004
		C2/ C3/ C3 Pluriel/ Berlingo	1.0/ 1.1/ 1.4	2002-2007
		Saxo/ Xsara	1.6 16V	1997-2006
		C2/ C3 Pluriel/ C4	1.6	1997-2006
		Xsara/ Xantia	1.8 16V	2002-2008
		ZX/ Xsara	2.0 16V	1996-2000
		Synergie/ Evasion/ Relay/ Jumper	2.0 Turbo	1994-2002
		Xsara	2.0 16V	2000-2004
Xsara/ C5/ Xsara Picasso		2.0HPI/ 2.0 16V/ 1.8	1999-2002	
Xsara/ C5/ Xsara Picasso		2.0HPI/ 2.0 16V/ 1.8	2002-2008	
PEUGEOT <i>Diesel</i>		205/ 305/ 405/ Partner/ Solara Express	1.8/ 1.9/ D/ TD	1982-2001
		306/ 309 Talbot Horizon/ 206/ 307	1.4 HDi	2001-2008
		206/ 306/ Express/ Partner	1.9D	1998-2007
		206/ 306/ 307/ 406/ 806/ 807	2.0HDI/ 2.0HDI 16V	1997-2007
		307/ 307 CC/ 407	2.0HDI	2003-2008
		406/ 607	2.2HDI	2002-2007
		406/ 806/ Expert/ Boxer	1.9D/ TD	1994-2002
		406/ 605/ 806	2.1D Turbo	1994-2002
	PEUGEOT <i>Gasolina</i>	106/ 205/ 306/ 307/ 405/ Partner	1.0/ 1.1/ 1.4/ 1.6	1993-2008
		206	1.1/ 1.4/ 1.6	1998-2008
		205/ 309/ 306/ 405/ 806/ 605/ 406/ Partner/ Boxer	1.6/ 1.9/ 1.8/ 2.0	1989-2002
		206/ 307	1.6 16V	2000-2008
		306/ 407	1.8 16V	1999-2002
		206/ 307/ 406/ 406 Coupe/ 607/ 806	2.0 16V	1998-2000
		306/ 406	1.8 16V	1995-1998
		306/ 406	2.0 16V	1994-2001
		306/ 406	1.6/ 2.0 Turbo	1994-2001
		406	1.8 16V	2000-2004
406/ 406 Coupe/ 607		2.2 16V	1998-2008	
807		2.0 16V	2002-2005	

RENAULT, NISSAN y DACIA
AL010038
20.00€
Kit calado del motor RENAULT/ NISSAN

Marca	Modelo	Motorización
RENAULT	Modus/ Laguna/ Kangoo/ Clio	1.5dCI/ 1.9dCI
NISSAN	Almera/ Micra	1.5dCI

AL010190
64.00€
Kit calado del motor

Marca	Modelo	Motorización	Año
RENAULT	Clio	1.2/ 1.4/ 1.6	
	Clio Sport	2.0	
	Espace	2.0	
	Scenic	1.4/ 1.6/ 1.8/ 2.0	
	Scenic II	1.4/ 1.6/ 2.0	
	Grand Scenic II	1.4/ 1.6	
	Laguna	1.8/ 2.0	
	Laguna II	2.0	
	Megane	1.4/ 1.6/ 1.8/ 2.0	
	Megane II	1.4/ 1.6/ 2.0	
DACIA	Logan	1.4/ 1.6	
	Sandero	1.4/ 1.6	
NISSAN	Micra		2003>2008
	Almera		2002>2006
	Note		2006>2008
	Qashqai		2007>2008
<i>Diesel</i>		1.2/ 1.4/ 1.6/ 1.8 (8v-16v)/ 2.0iDE/ 2.0Turbo	

Códigos motor: D4F/ K4J/ K4M/ K7M/ K9K/ F4P/ F3R/ F4R/ F5R/ F4RT



Herramienta - aplicación especial por MARCAS GRUPO VAS - AUDI, VOLKSWAGEN, SKODA, SEAT y PORSCHE

AI010069 24.00€

Llave bloqueadora del cigüeñal VOLKSWAGEN

Para bloquear el cigüeñal cuando se desea cambiar la correa u otros componentes

Marca	Modelo	Motorización
AUDI	A4/ A6	
SEAT	Alhambra/ Altea/ Arosa/ Cordoba/ Ibiza/ Leon/ Toledo	
VOLKSWAGEN	Bora/ Golf/ Lupo/ Passat/ Polo	TDI's

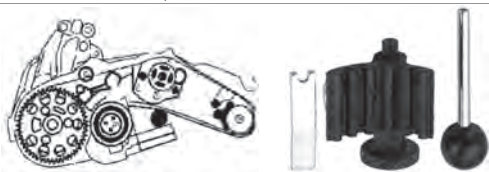

AI010070 29.80€

Llave bloqueadora del cigüeñal VOLKSWAGEN

Marca	Modelo	Motorización
AUDI	A2	1.4TDI
	A3	1.9TDI/ 2.0TDI
	A4	1.6TDI/ 1.9TDI/ 2.0TDI
	A6	1.9TDI
SEAT	Altea	1.9SDI/ TDI
	Leon	1.9/ 2.0TDI
	Toledo	1.9SDI/ TDI
VOLKSWAGEN	Beetle/ Bora/ Sharan	1.9TDI
	Fox/ Lupo	1.4TDI
	Golf	1.9/ 2.0TDI
	Polo	1.4/ 1.9TDI



AI020127 45.00€

Herramienta de extracción de inyectores

Aplicación: Grupo VAS (motores TDI)



AI020154 293.00€

Instalador retén cigüeñal VOLKSWAGEN

Marca	Modelo	Año
AUDI	A3	2004>
	A4	
SKODA	Octavia2/ Roomster/ Fabia	
VOLKSWAGEN	Golf	2004>
	Transporter T5/ Caddy/ Touran	2004>



AI020184A 14.50€

Llave para inyectores BMW y VOLKSWAGEN

Cuadrado: 1/2"
Medida: 14mm
Longitud: 119mm



AI050079 12.60€

Llave bujía caja de velocidades y transmisiones 1/2"

Marcas: AUDI y VOLKSWAGEN
Llave estriada XZN Tamperproof M16



AI050201 35.50€

Varilla de aceite

Aplicación: Audi/ Volkswagen



AL010029 31.50€

Herramienta de alineación doble árbol levas motores gasolina

Marca	Modelo	Motorización
AUDI	A2	1.4/ 1.6
SEAT	Arosa/ Ibiza/ Cordoba/ Toledo/ Leon/ Inca	1.4/ 1.6
SKODA	Fabia/ Octavia	1.4/ 1.6
VOLKSWAGEN	Lupo/ Polo/ Golf/ Bora/ Beetle/ Caddy	1.4/ 1.6



AL010053A 58.20€

Kit calado del motor

Marca	Modelo	Motorización	Año
VOLKSWAGEN	Polo	1.2 6V/ 12V	2002>
SEAT	Ibiza	1.2 6V	2002>
SKODA	Fabia	1.2 6V/ 12V	2003>



AL010072 8.30€

Kit calado del motor

Marca	Modelo
AUDI	A4/ S3/ A6/ TT
SEAT	Ibiza/ Cordoba/ Leon/ Toledo/ Alhambra
SKODA	Octavia
VOLKSWAGEN	Golf/ Bora/ Beetle/ Passat



AL010087
198.00€
Kit calado del motor AUDI

Marca	Modelo	Motorización
AUDI	A4	3.2FSI
	A6	2.4
	A6	2.4quattro
	A6	3.2FSI A)
	A8	3.2FSI A

AL010088
79.00€
Kit calado del motor a gasolina

Marca	Modelo	Motorización
AUDI	A3	1.4L/ 1.6 FSI
SKODA	Octavia	
VOLKSWAGEN	Polo/ Golf/ Golf Plus/ Jetta/ Passat/ Touran	

AN010202
28.00€
Llave de impacto especial XZN 3/4" para bujes de las ruedas AUDI/ VOLKSWAGEN

 Medida: M18
 Longitud: 105mm

AN010202B
12.50€
Llave de impacto XZN 1/2" AUDI/ VOLKSWAGEN

Especialmente diseñado para apretar los tornillos que sujetan el eje trasero

 Medida: M18
 Longitud: 78mm

AI010108
24.00€
Regulador tensor del rodillo

Marca	Modelo
AUDI	A4/ A6/ Cabrio
SEAT	Ibiza
SKODA	Superb
VOLKSWAGEN	Polo/ EOS/ Passat

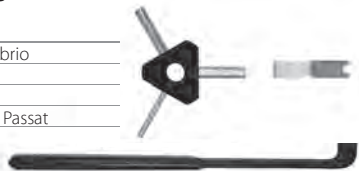
AL010291
119.00€
Kit calado del motor VAS

AI010110
220.00€
Juego sincronizar motor - grupo VAS

Marca	Modelo	Motorización	Año
AUDI	A3	1.6FSI	2003-2006
	A3/ S3	1.8Turbo	1996-2003
	A4/ A6	1.8Turbo	1994-2006
	Cabriolet		1997-2000
	TT	1.8Turbo	1998-2006
SEAT	Ibiza	1.8Turbo	1999-2002
	Cordoba	1.8Turbo	
	Leon	1.8Turbo	1999-2005
	Toledo	1.8Turbo	1999-2005
SKODA	Octavia	1.8Turbo	1996-2005
	Octavia	1.8Turbo	2000-2005
	20V RS		
VOLKSWAGEN	Golf	1.6FSI	
	Touran	1.6FSI	
	Beetle	1.8Turbo	1999-2006
	Golf/ Bora	1.8Turbo	1997-2005

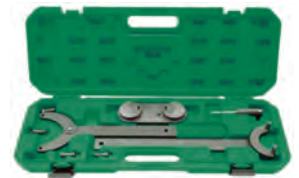
AL010202
6.50€
Pin fijación cigüeñal - grupo VAS

Esta llave es equivalente a la herramienta VAG T10340

Marca	Modelo	Motorización
VOLKSWAGEN	Polo/ Golf/ Golf VI Cabrio/ Golf Plus/ Golf Variant/ Touran/ EOS/ Passat/ Jetta/ Scirocco/ Beetle/ Sharan/ Tiguan/ Caddy/ Caddy Maxi/ Fox	1.4/1.6TSI/FSI
AUDI	A3	1.4/1.6TSI/FSI
SEAT	Cordoba/ Ibiza	1.4/1.6TSI/FSI
SKODA	Fabia/ Roomster	1.4/1.6TSI/FSI



Códigos del motor: AWY/ AXU/ AZQ/ BAG/ BBM/ BKG/ BLF/ BLG/ BLN/ BLP/ BMD/ BME/ BMY/ BTS/ BWK/ BZG/ CAVA/ CAVB/ CAVC/ CAVD/ CAXA/ CEVA/ CGPA/ CGPB/ CHFA

AL010203
6.40€
Pin fijación cigüeñal - grupo VAS

Esta llave es equivalente a la herramienta VAG T40069

Marca	Motorización
AUDI/ SEAT/ SKODA/ VOLKSWAGEN	2.0/ 2.4/ 3.2FSI/ 3.0 V6 TDI/ 4.2 V8 TDI/ 2.8/ 1.4/ 1.6 TSI/FSI

Código del motor: BGP/ BGQ/ CBUA/ CBTA/ BPR/ BPS

AL010225
78.00€
Kit calado del motor VOLKSWAGEN

Modelo	Motorización	Año
Transporter	2.4TD4	1995>2003
Código del motor: AAB/ AJA		
Transporter	2.5TDI	1995>2003
Código del motor: ACV/ AHY/ AJT/ AUF/ AXG/ AXL/ AYC		
Crafter	2.5TDI	2006 >2012
Código del motor: BJJ/ BJK/ BJL/ BJM		



ME010001 428.00€

Juego de guías para sellar la horquilla

Composición:

Ref.	Longitud (mm)
329-01	449/50
329-02	45
329-03	43
329-04	41
329-05	39
329-06	35/36
329-07	48
329-08	54
329-09	46/47



ME010007 34.00€

Llave montaje/ desmontaje de horquilla invertida



ME010009 11.00€

Extractor de raspador de suspensión



ME010010 19.50€

Juego de guías para bujes suspensión

Composición/ medidas (mm):
12,5; 14; 16 y 18



ME010012 32.00€

Guía montaje/ desmontaje de horquilla invertido



ME020001 39.00€

Extractor de cojinete de eje de dirección

Apertura: 30-68mm



ME020002 61.00€

Herramienta para montaje de cojinete de dirección



ME020003 310.00€

Extractor de cojinete de volante (manillar)



ME020005 90.00€

Guía para montaje de cojinete de dirección



ME020006 250.00€

Dispositivo de compresión para instalación dos avances

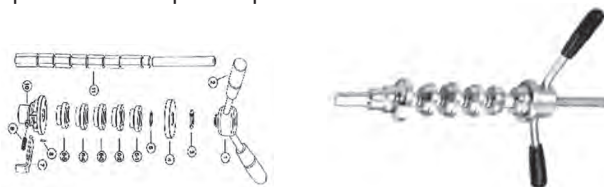

MG010001 35.00€

Extractor de buje del embrague/ polea alternador



MG01000

Llave hembra de embrague

Ref.	Medida (mm)	Pin	Precio
MG010002	34x59	2	20.00€
MG010003	41x59	2	20.00€
MG010004	39x72	2	23.00€
MG010005	46x72	2	23.00€
MG010006	46	3	23.00€



MG010008 30.00€

Herramienta de muelles de embrague

Para motores 50 a 250cc
con polea de ø125 a 155mm



MG010009 39.00€

Herramienta de muelles de embrague

Para motores 50 a 250cc
con polea de ø125 a 155mm



MG020001

34.00€

Corta cadena

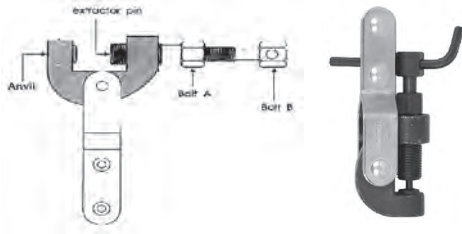

MG020003

75.00€

Corta/ remachadora de cadena



MG020004

12.50€

Alicate para argolla de unión

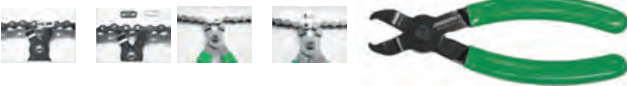

MG020006

15.00€

Extractor de argolla de unión



MG020007

55.00€

Kit de limpieza para cadena

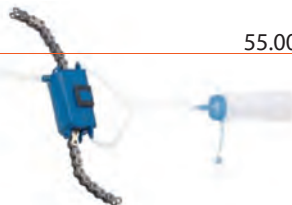

MG020008

14.00€

Cepillo limpia rodillos



MI010014

23.00€

Extractor válvulas motor



MI010016

47.00€

Removedor/instalador del pin del pistón

Medidas (mm):

Pistones: 40 a 100
Pin: 12 a 25



MI010017

24.00€

Instalador de segmentos del pistón



MI010018

22.60€

Protector en aluminio para tornillo de banco

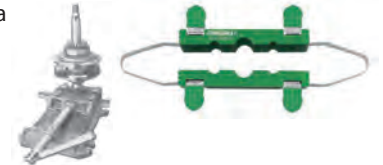

MI010019

193.00€

Herramienta de ayuda para el cierre del motor



MI010020

27.00€

Soporte cigüeñal



MI010021

23.00€

Extractor de avance



MI020001

12.30€

Llaves para jets 6 y 8mm



MI020002

19.00€

Juego de llaves para carburadores FCR



MI020004

25.80€

Escalímetro de carburadores



MN020004

8.00€

Protector de llantas



MN020005

5.00€

Desmontador de neumáticos



MT010001

8.90€

Fijador del cable del embrague y del freno

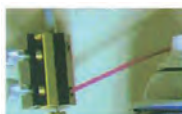

MT010002

46.50€

Herramienta perforación hembra y tornillo de seguridad



MT010003

132.00€

Caballete rueda trasera



MT010004

130.00€

Soporte central universal



MT010005

23.00€

Herramienta retención universal



MT010006

25.50€

Soporte polea



MT010007

38.00€

EZ-ROLL



MT010008

8.90€

Gancho para muelles



CHAPISTA

AB010001

48.00€

Kit de 10 piezas para colocación de cristales



AB010002

86.00€

Herramientas para quitar parabrisas



AB010002-A

16.60€

Bobina de alambre para retirar cristales - 15m



AB010017

20.00€

Cuchillo parabrisas



AB0100

Hoja de acero para recambio

Ref.	Medida	Precio
AB010018	3/4"	1.90€
AB010019	1"	1.90€
AB010020	1-1/2"	1.95€



AB010026S

36.00€

Kit quita tapizados de plástico



AB010041

40.00€

Juego de 12 llaves para extracción paneles



AB010043

57.00€

Espejo auxiliar para reparación de abolladuras



AB020002

21.00€

Ventosa simple para cristales



AB020003

50.00€

Ventosa doble para cristales



AB020009

47.00€

Ventosa doble articulada para cristales

Estructura en aluminio
Ventosas: ø115mm



AB020010

67.00€

Triple ventosa para cristales

Estructura en aluminio
Ventosas: ø123mm
Capacidad: 35 kg/100 kg



AB020015

7.70€

Juego de ventosas para cambio de cristales



Chapista

AB020019

40.00€

Juego de 6 ventosas

Para ayudar a encolar cristales, etc



AB030001

6.60€

Juego de 4 espátulas de 25 a 100mm



AB030014

10.60€

Herramienta para colocación de gomas de cristales



AB030028

4.50€

Llave quita grapas



AB030041

5.10€

Llave quita grapas



AB030043

4.70€

Llave quita grapas



AB030046

4.70€

Llave quita grapas



AB030047

3.50€

Llave quita grapas



AB030048

6.60€

Llave quita grapas



AB030060 47.00€

Juego de 2 alicates para grapas de plástico



AB030068A 30.50€

Palanca de chapista

Medida: 380mm



AB030068C 38.80€

Palanca de chapista

Medida: 900mm



AB030068D 35.00€

Palanca de chapista

Medida: 750mm



AB030068F 24.50€

Palanca de chapista

Medida: 450mm



AB030069A 25.00€

Cuña de chapista

Medida: 125mm



AB030069B 34.50€

Cuña de chapista

Medida: 137mm



AB030069E 8.60€

Cuña de chapista

Medida: 48mm



AB030094J 10.00€

Cuña de chapista

Medida: 84,7mm



AB030070B 25.00€

Sufridera de cuña simple



AB030070C 21.90€

Sufridera de cuña simple



AB030070D 33.80€

Sufridera de coma



AB030089 141.00€

Juego de 7 TAS de chapista para aluminio en polietileno de alta densidad



AB030100 62.00€

Martillo para aluminio con accesorios



AB030071 39.00€

Martillo de cabeza redonda dentado para recoger



M10110 24.50€

Martillo de cabeza redonda y punta plana



M10210A 20.50€

Martillo de cabeza plana redonda y punta curva



M10210B 20.50€

Martillo de cabeza plana redonda y plana derecha



M10410A 26.50€

Martillo de cabeza redonda plana y cuadrada para encaje picotado



M10410B 26.50€

Martillo de cabeza redonda plana y cuadrada para encaje picotado



AG010023
11.10€

Base para lija en plástico ABS
Dimensiones: 106x212mm

AG010024
32.00€

Soporte flexible para lima de chapista
Para limas de 355mm

AG010024

Lima para AG010024

Ref.	Sierra	Longitud	Precio
AG010024-1	9	14"/355mm	31.00€
AG010024-2	12	14"/355mm	36.50€

AG010030A
163.00€

Juego de martillos y TAS

AG010185
108.00€

Alicate de rebordear

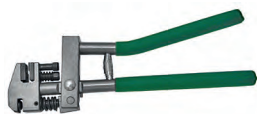
AG010055
25.00€

Destornillador de golpe con accesorios

AG010055-B
3.20€

Juego de 4 puntas para AG010055/AG010138

Composición:

Fenda: 8 y 10mm
Philips: PH2 y PH3

AE310003
105.00€

Juego saca abolladuras

Chapista
AE330004
76.00€

Garra de chapista una dirección
Capacidad: 3t

AE330005
77.00€

Garra de chapista dos direcciones
Capacidad: 2t (transversal)
3t (longitudinal)

AE330008
61.00€

Garra de chapista dos direcciones
Capacidad: 2t (empuje transversal)
3t (empuje recto)

AE330009
135.00€

Garra de chapista tipo alicate una dirección
Capacidad: 3t

AE330013
133.00€

Garra de chapista dos direcciones
Capacidad: 3t (transversal)
5t (longitudinal)

AE330015
241.00€

Garra de chapista dos direcciones de dos puntos
Capacidad: 5t

AE330016
46.50€

Gancho para unir a la cadena
Capacidad: 6t

AE330030
88.00€

Punto fijo de empuje
Capacidad: 5t

AE330034
200.00€

Pinza de chapista de posición variable hasta 90°
Capacidad: 5t



AE330035

95.00€

Pinza de chapista
Capacidad: 5t



AG010138

23.20€

Destornillador de golpe con accesorios 13 puntas de 36mm

Phillips: PH1; PH2; PH3 y PH4
Fenda: 5; 6; 8; 10 y 12mm
Hexagonales: 4; 5; 6 y 8mm



AG010138-B

8.10€

Juego de 13 puntas para AG010138/AG010055



AG010140

12.30€

Mini TAS universal



AG010141

66.50€

Cinzel para chapista con puntas intercambiables



AG010142

60.00€

Martillo cinzel para chapista con puntas intercambiables



AG010143

67.50€

Cinzel con botadores y cortafrios intercambiables



AL010113 33.00€

Llave de 1/2" para girar el cigüeñal

Aplicación: SCANIA



AL010114 46.00€

Llave de 1/2" para alinear el cigüeñal

Aplicación:

Marca Motorización

MERCEDES 6.8/ 10 cilindros

MAN 12 cilindros



AL010116 57.00€

Llave de 11 dientes para alinear el cigüeñal

Medida: Tornillo hexagonal de 24mm

Aplicación: DAF CF65/ CF75/ CF85/ F65/ F75/ F85/ F95/ XF95



AL010117 31.50€

Llave de 1/2" para alinear el cigüeñal

Aplicación: DAF XF105 euro



AN010187 157.00€

Alicate para correas de freno

Aplicación: VOLVO



AI010153 19.50€

Llave sensor de posición con 8 caras de 1/2"

No utilizar con máquinas neumáticas

Medida: 27mm

Longitud: 60mm

Aplicación: MERCEDES Actros/ série SK/ MAN/ SCANIA



AI020164 31.50€

Llave para girar válvula electromagnética con 8 caras de 3/4"

Medida: 38mm

Longitud: 100mm

Aplicación: SCANIA



AI040245 26.00€

Llave para rodamientos cigüeñal de 3/4"

Medida: E28 - Torx

Longitud: 90mm

Aplicación: SCANIA



AI050135 132.00€

Juego de llaves de copa para filtros - pesados

Composición:

Llave 6 caras 36mm

Llave 15 caras 74mm

Llave 15 caras 106mm

Llave 15 caras 107mm

Llave 18 caras 108mm

Llave 18 caras 135mm

Llave de cinta Ø 160mm

Llave 21mm



AI050172 155.00€

Llave de filtros ajustable de 1/2"

Medida: 104-150mm



AN010235 62.00€

Llave hembra de 3/4" para montaje/desmontaje embrague

Diámetro interno: 64mm

Diámetro externo: 79mm

Aplicación: SCANIA

Picos: 7mm

Aplicación: SCANIA



AN010237 125.00€

Extractor para articulaciones tirante de freno

Haldex



AN040062 34.50€

Llave de montaje/desmontaje inyectores

Aplicación: SCANIA/ MERCEDES/ MAN



AN040066 182.00€

Extractor de rótulas

Medida: 39mm

Aplicación: SCANIA/ MERCEDES/ MAN/ HINO



AN040105 165.00€

Llave para rueda trasera con 8 caras de 1"

Medida: 100mm

Aplicación: SCANIA



AN040200 114.00€

Extractor de cubo para rueda frontal de 1"

Medida: 80mm

Aplicación: SCANIA



AG01016

Llave de rueda doble

Ref.	Medida (mm)	Diámetro barra (mm)	Precio
AG010167	24x27	3/4" x 600	44.00€
AG010168	30x32	3/4" x 600	50.00€
AG010169	32x33	3/4" x 600	52.00€



AI050110

Llave de cadena para filtros

Longitud de cadena: 520mm
Filtros: 60-165mm

57.00€



AB030076

Grapas de plástico

Ref.	Cantid. Embl.	Precio
AB030076-01	300	19.50€
AB030076-02	300	19.50€
AB030076-03	200	19.50€
AB030076-05	150	17.00€
AB030076-06	150	17.00€
AB030076-07	200	19.40€
AB030076-11	200	19.40€
AB030076-13	200	19.40€
AB030076-14	100	20.80€
AB030076-15	100	21.00€
AB030076-17	100	20.80€
AB030076-18	200	19.50€
AB030076-20	200	20.00€
AB030076-21	100	23.00€
AB030076-24	100	22.00€
AB030076-26	100	24.70€
AB030076-27	100	24.90€
AB030076-28	100	24.90€
AB030076-30	100	21.00€
AB030076-32	100	20.90€
AB030076-34	200	36.00€



AN04005

Llave para quitar el tapón del buje de la rueda trasera

Ref.	Medida (mm)	Precio
AN040055	111	152.00€
AN040056	120	156.00€



AB030076-00

89.00€

Juego de 21 tipo de muelles con 20 piezas cada uno
Caja de plástico



AI020158

106.00€

Juego de 150 anillas de cobre para inyectores con 15 medidas

Composición:

13,85x7,3x1,4; 14,60x7,5x1,3; 14,60x7,5x3,0; 15x7x2;
15x7,5x1; 15x7,5x1,5; 15x7,5x2; 15x7,5x2,5; 15x7,5x3;
15,5x7,5x2; 16x7,5x1,5; 16x7,5x1,7; 16x7,5x2; 16x7,4x2
y 20x9,4x0,9



AR030022

74.00€

Juego de 530 terminales automóvil con 18 tipos





JONNESWAY®

Herramienta Neumática



**Herramienta
neumática**

**Accesorios
para redes de
aire comprimido**



JAI-1024

190.00€

Máquina con llave de impacto de 1/2"

- Características:
- Rotación en vacío: 10 000rpm
 - Par trabajo: 510Nm
 - Par máximo: 570Nm
 - Longitud: 99mm
 - Peso: 1 400g
 - Consumo de aire: 127l/min
 - Presión operacional: 6,2bar
 - Ruido: 97dB



JAI-1024-RK

11.00€

Kit de reparación para JAI-1024

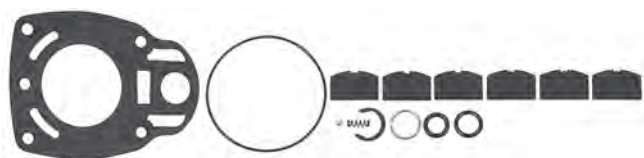

JAI-1124

197.00€

Máquina compacta de impacto de 1/2"

Máquina de composite preparada para trabajo intensivo de 2 percutores y 3 velocidades de apriete y 1 velocidad de aflojamiento (máxima potencia). Portada de aleación de aluminio resistente.

- Características:
- Revoluciones en vacío: 9 500rpm
 - Par trabajo: 560Nm
 - Par máximo: 620Nm
 - Longitud: 112mm
 - Peso: 1 150g
 - Consumo del aire: 136l/min
 - Presión operacional: 6,2bar
 - Ruido: 99,9dB



BREAKAWAY

par 1 100Nm

JAI-1124-RK

13.00€

Kit de reparación para JAI-1124



JAI-1114

203.00€

Máquina con llave de impacto de 1/2"

Máquina de composite preparada para trabajo intensivo con mecanismo de 2 percutores.

- Características:
- Revoluciones en vacío: 9 500rpm
 - Par trabajo: 880Nm
 - Par máximo: 1 356Nm
 - Longitud: 190mm
 - Peso: 2 300g
 - Consumo del aire: 207l/min
 - Presión operacional: 6,2bar
 - Ruido: 99,2dB



JAI-1114K

270.00€

Máquina de impacto de 1/2" con kit de llaves

Máquina de composite con mecanismo de 2 percutores.

- Características:
- Revoluciones en vacío: 9 500rpm
 - Par trabajo: 880Nm
 - Par máximo: 1 356Nm
 - Longitud: 190mm
 - Peso: 2 300g
 - Diámetro interior: 10mmø
 - Consumo del aire: 207l/min
 - Ruido: 99,2dB



Accesorios:

- 10 Llaves impacto de 1/2": 9; 10; 11; 13; 17; 19; 22; 24 y 27mm
- 1 Extensión de 125mm
- 1 Kit de mantenimiento

JAI-1114-RK

15.50€

Kit de reparación para JAI-1114



JAI-1524

152.00€

Máquina neumática de impacto de 1/2"

Máquina de composite para trabajo intensivo con mecanismo de 2 percutores.

- Características:
- Revoluciones en vacío: 8 500rpm
 - Par trabajo: 840Nm
 - Par máximo: 1 080Nm
 - Longitud: 190mm
 - Peso: 2 500g
 - Diámetro interior: 10mmø
 - Consumo del aire: 125l/min
 - Ruido: 104,8dB
 - Posiciones de apriete: 3
 - Aflojar posiciones: 1



JAI-1524-RK

10.00€

Kit de reparación para JAI-1524



JAI-0954

248.00€

Máquina de impacto de 1/2"

Máquina de composite con mecanismo de 2 percutores (Twin Hammer).

Caraterísticas:

Revoluciones en vacío: 8 500rpm
 Par trabajo: 880Nm
 Par máximo: 1 356Nm
 Longitud: 181mm
 Peso: 1 900g



JAI-0954-RK

21.00€

Kit de reparación para JAI-0954



JAI-1232K

175.00€

Máquina para quitar bujías de incandescencia de 1/4" con kit de llaves

Interruptor de dirección de la máquina construida en el botón de encendido, lo que permite efectuar el cambio de dirección con una mano.

4 Posiciones ajustables para 20, 30, 40, y 45Nm.

Características:

Revoluciones en vacío: 11 000rpm
 Par: 20-45Nm
 Longitud: 180mm
 Peso: 800g
 Consumo del aire: 150l/min
 Presión operacional: 6,2bar
 Ruido: 102dB

Accesorios:

Llaves de vaso largas: 8; 9; 10; 11 y 12mm
 Cardán
 Extensión



JAI-1232-RK

13.80€

Kit de reparación para JAI-1232



JAI-1054

237.00€

Máquina con llave de impacto de 1/2"

Máquina para trabajo intensivo con mecanismo de 2 percutores.

Características:

Revoluciones en vacío: 8 000rpm
 Par trabajo: 780Nm
 Par máximo: 920Nm
 Longitud: 186mm
 Peso: 2 560g
 Diámetro interior: 13mmø
 Consumo del aire: 119l/min
 Ruido: 90dB



JAI-1054-RK

24.50€

Kit de reparación para JAI-1054



JAI-1513

248.00€

Máquina neumática de impacto angular de 3/8"

Características:

Revoluciones en vacío: 6 500rpm
 Par trabajo: 339Nm
 Par máximo: 380Nm
 Longitud: 248mm
 Peso: 1 350g
 Diámetro interior: 10mmø
 Consumo del aire: 119l/min
 Ruido: 105dB



JAI-1513-RK

21.00€

Kit de reparación para JAI-1513



JAI-1514

247.00€

Máquina neumática de impacto angular de 1/2"

Características:

Revoluciones en vacío: 6 500rpm
 Par trabajo: 407Nm
 Par máximo: 460Nm
 Longitud: 248mm
 Peso: 1 400g
 Diámetro interior: 10mmø
 Consumo del aire: 119l/min
 Ruido: 105dB



JAI-1514-RK

21.50€

Kit de reparación para JAI-1514



JAI-0926-RK

42.50€

Kit de reparación para JAI-0926



JAI-0936

680.00€

Máquina con llave de impacto de 3/4"

Máquina de composite preparada para trabajo intensivo con mecanismo de 2 percutores.

Características:

Revoluciones en vacío: 6 500rpm
 Par trabajo: 1 620Nm
 Par máximo: 2 025Nm
 Longitud: 225mm
 Peso: 1 940g
 Diámetro interior: 13mmø
 Consumo del aire: 190l/min
 Ruido: 90,5dB



JAI-0936-RK

66.00€

Kit de reparación para JAI-0936



JAI-6212K

470.00€

Máquina con llave de impacto de 3/4" con kit de vasos
 Máquina con mecanismo pin clutch.

Características:

Revoluciones en vacío: 4 800rpm
 Par máximo: 1 086Nm
 Peso: 4 900g
 Diámetro interior: 13mmø

Accesorios:



Llaves: 26-38mm
 Kit manutención
 Maleta



JAI-6212-RK1

21.00€

Kit de reparación para JAI-6212

JAI-6211

420.00€

Máquina con llave de impacto de 3/4" (19mm)
 Máquina con mecanismo de 2 percutores.

Características:

Revoluciones en vacío: 6 500rpm
 Par máximo: 1 016Nm
 Peso: 4 550g
 Diámetro interior: 13mmø



JAI-6211-RK

36.00€

Kit de reparación para JAI-6211



JAI-1206L

900.00€

Máquina con llave de impacto de 3/4"

Máquina para trabajo intensivo con eje largo y mecanismo de 2 percutores.

Características:

Revoluciones en vacío: 5 500rpm
 Par trabajo: 2 100Nm
 Par máximo: 2 300Nm
 Longitud: 465mm
 Peso: 6 400g
 Diámetro interior: 19mmø
 Consumo del aire: 212l/min
 Ruido: 106dB

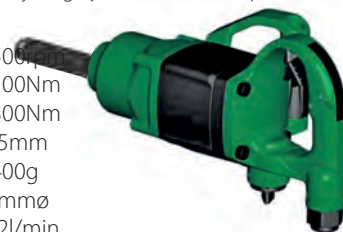

JAI-1206L-RK

61.00€

Kit de reparación para JAI-1206



JAI-0938

760.00€

Máquina con llave de impacto de 1"

Máquina de composite para trabajo intensivo con mecanismo de 2 percutores.

Caraterísticas:

Revoluciones en vacío: 6 500rpm
 Par trabajo: 1 740Nm
 Par máximo: 2 150Nm
 Longitud: 230mm
 Peso: 4 100g
 Consumo del aire: 190l/min
 Presión operacional: 6,2bar
 Ruido: 190,5dB



JAI-0938-RK

63.00€

Kit de reparación para JAI-0938



JAI-1138

775.00€

Máquina con llave de impacto de 1"

Máquina de eje corto con mecanismo de 2 percutores.

Características:

Revoluciones en vacío: 5 000rpm
 Par trabajo: 2 430Nm
 Par máximo: 2 712Nm
 Longitud: 347mm
 Peso: 7 400g
 Diámetro interior: 19mmø
 Consumo del aire: 255l/min
 Ruido: 100dB



JAI-1138-RK

95.00€

Kit de reparación para JAI-1138/ JAI-1138L



JAI-1138L

810.00€

Máquina con llave de impacto de 1"

Máquina de eje largo con mecanismo de 2 percutores.

Características:

Revoluciones en vacío: 5 000rpm
 Par trabajo: 2 430Nm
 Par máximo: 2 712Nm
 Longitud: 487mm
 Peso: 8 300g
 Diámetro interior: 19mmø
 Consumo del aire: 255l/min
 Ruido: 100dB



JAI-1408

1 380.00€

Máquina con llave de impacto pesados de 1"

Máquina de eje corto.

Características:

Revoluciones en vacío: 4 800rpm
 Par trabajo: 3 270Nm
 Par máximo: 3 520Nm
 Longitud: 370mm
 Peso: 10 500g
 Consumo del aire: 450l/min
 Presión operacional: 6,3bar
 Ruido: 105,5dB



JAI-1408-RK

82.00€

Kit de reparación para JAI-1408/ JAI-1408L



JAI-1408L

1 420.00€

Máquina con llave de impacto pesados de 1"

Máquina de veio longo.

Características:

Revoluciones en vacío: 4 800rpm
 Par trabajo: 3 270Nm
 Par máximo: 3 520Nm
 Longitud: 570mm
 Peso: 11 900g
 Consumo del aire: 450l/min
 Presión operacional: 6,3bar
 Ruido: 105,5dB



JAI-6202-RK

65.00€

Kit de reparación para JAI-6202



JAI-0501-RK

22.00€

Kit de reparación para JAI-0501

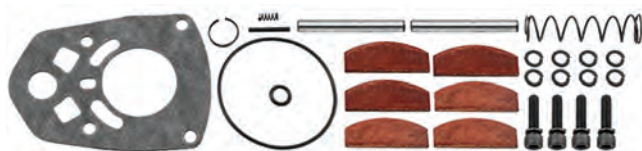

JAR-1012

92.00€

Carraca neumático de 1/4"

Características:

Revoluciones en vacío: 230rpm
 Par máximo: 40Nm
 Longitud: 140mm
 Peso: 469g
 Diámetro interior: 10mmø
 Consumo del aire: 338l/min



JAR-1012-RK

34.00€

Kit de reparación para JAR-1012



JAR-1013

91.00€

Carraca neumático de 3/8"

Características:

Revoluciones en vacío: 230rpm
 Par máximo: 40Nm
 Longitud: 140mm
 Peso: 469g
 Diámetro interior: 10mmø
 Consumo del aire: 338l/min



JAR-1013-RK

34.00€

Kit de reparación para JAR-1013



JAR-1094

118.00€

Carraca neumático de 1/2"

Características:

Revoluciones en vacío: 170rpm
 Par máximo: 100Nm
 Longitud: 275mm
 Peso: 1 400g
 Diámetro interior: 10mmø
 Consumo del aire: 113l/min
 Ruido: 87dB



JAR-1094-RK

37.00€

Kit de reparación para JAR-1094



JAR-6309AK

147.00€

Carraca neumático de 1/2" con kit de llaves

Características:

Revoluciones en vacío: 170rpm
 Par máximo: 100Nm
 Longitud: 275mm
 Peso: 1 400g
 Diámetro interior: 10mmø



Accesorios:

Llaves: 9; 10; 11; 13; 14; 17 y 19mm
 Extensión: 75mm
 Unión universal de 1/2"
 Puntas y porta puntas
 Maleta



JAR-6309A-RK

30.00€

Kit de reparación para JAR-6309A



JAR-6310A

105.00€

Carraca neumático de 3/8"

Características:

Revoluciones en vacío: 170rpm
 Par máximo: 100Nm
 Longitud: 275mm
 Peso: 1 300g
 Diámetro interior: 10mmø



JAR-6310A-RK

29.00€

Kit de reparación para JAR-6310A



JAR-6310AK

145.00€

Carraca neumático de 3/8" con kit de llaves

Características:
 Revoluciones en vacío: 170rpm
 Par máximo: 100Nm
 Longitud: 275mm
 Peso: 1 300g
 Diámetro interior: 10mmø



Accesorios:

Llaves: 9; 10; 11; 13; 14; 17 y 19mm
 Extensión: 75mm
 Unión universal de 3/8"
 Puntas y porta puntas
 Maleta



JAR-1033

320.00€

Carraca neumático combinado de 3/4" con kit de llaves

Características:
 Revoluciones en vacío: 180rpm
 Par máximo: 107Nm
 Longitud: 9,5mm
 Peso: 1 400g
 Diámetro interior: 10mmø



Accesorios:

Llaves: 8 a 19mm
 Adaptadores



JAR-1033-RK

80.00€

Kit de reparación para JAR-1033A



JAD-0212

118.00€

Taladradora neumática de 1/4"

Máquina de composite.

Características:
 Revoluciones en vacío: 1 800rpm
 Potencia: 2cv
 Longitud: 199mm
 Peso: 780g
 Diámetro interior: 10mmø
 Consumo del aire: 54,4l/min
 Ruido: 97dB



JAD-0212-RK

10.20€

Kit de reparación para JAD-0212

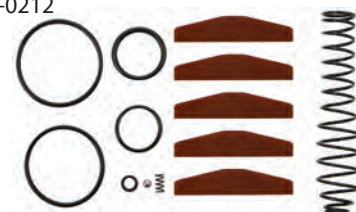

JAD-0413

120.00€

Taladradora reversible neumática de 3/8"

Características:
 Revoluciones en vacío: 1 800rpm
 Motor: 0,4cv
 Capacidad del mandril: 10mm
 Longitud: 210mm
 Peso: 950g
 Diámetro interior: 10mmø
 Consumo del aire: 99l/min
 Vibración: 3,3m/s²
 Ruido: 80dB



JAD-0413-RK

12.50€

Kit de reparación para JAD-0413



JAD-0534

329.00€

Taladro neumático de 1/2"

Características:
 Potencia: 0,6cv
 Revoluciones en vacío: 7 000rpm
 Longitud: 240mm
 Peso: 1 400g
 Consumo del aire: 113 l/m
 Ruido: 97 dB



JAD-1020

109.00€

Taladradora reversible neumática de 1/2"

Características:

- Revoluciones en vacío: 800rpm
- Capacidad del mandril: 13mm (apert con llave)
- Longitud: 220mm
- Peso: 1 300g
- Diámetro interior: 10mmø



JAD-1020-RK

2.50€

Kit de reparación para JAD-1020



JAD-1021

126.00€

Taladradora neumática angular de 3/8"

Características:

- Revoluciones en vacío: 1 900rpm
- Capacidad del mandril: 10mm (apert con llave)
- Longitud/ altura: 190x110mm
- Peso: 960g
- Diámetro interior: 10mmø
- Consumo del aire: 280l/min



JAD-1021-RK

13.90€

Kit de reparación para JAD-1021



JAD-1027

140.00€

Taladradora reversible neumática de 1/2"

Características:

- Revoluciones en vacío: 800rpm
- Capacidad del mandril: 13mm (apert sin llave)
- Longitud: 178mm
- Peso: 1 820g
- Diámetro interior: 10mmø



JAD-1027-RK

2.40€

Kit de reparación para JAD-1027



JAD-6252A

73.00€

Taladradora neumática de 3/8"

Características:

- Revoluciones en vacío: 2 500rpm
- Capacidad del mandril: 9,5mm (apert con llave)
- Longitud: 228mm
- Peso: 900g
- Diámetro interior: 10mmø



JAD-6252A-RK

4.00€

Kit de reparación para JAD-6252



JAB-1017

110.00€

Atornilladora neumática reversible de 1/4"

Características:

- Revoluciones en vacío: 1 800rpm
- Capacidad del mandril: 1/4"
- Longitud: 190mm
- Peso: 1 100g
- Diámetro interior: 10mmø



JAB-1017-RK

2.10€

Kit de reparación para JAB-1017



JAB-1018

125.00€

Atornilladora neumática reversible de 1/4"

Características:

- Revoluciones en vacío: 800rpm
- Capacidad del mandril: 1/4"
- Longitud: 226mm
- Peso: 1 300g
- Diámetro interior: 10mmø



JAB-1018-RK

2.10€

Kit de reparación para JAB-1018



JAB-7003A
130.00€
Atornilladora neumática reversible de 1/4"
Características:

Revoluciones en vacío:	1 800rpm
Capacidad del mandril:	1/4"
Longitud:	254mm
Peso:	1 140g
Diámetro interior:	10mmø

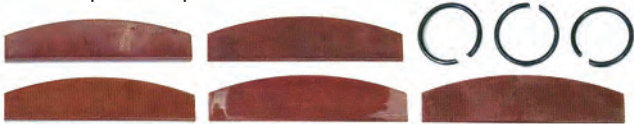
JAB-7003A-RK
4.60€
Kit de reparación para JAB-7003A

JAD-1015K
350.00€
Fresadora de puntos de soldadura con kit de accesorios
Características:

Revoluciones en vacío:	1 800rpm
Capacidad perforación:	8mm
Longitud:	254mm
Peso:	2 100g
Diámetro interior:	10mmø

Accesorios:

Llave 6 caras: 2,5mm
Fresas
Lubrificador
Racor: 1/4"x1/4"
Maleta

JAD-1015-RK
2.60€
Kit de reparación para JAD-1015K

JAZ-7207
85.00€
Juego de 5 fresas para fresadora de puntos

Aplicable a los modelos: JAD-1015/ JAD-6246

Características:

Fresas en HSS y cobalto
Diámetro: 6,5mmø

JAG-0903-MS
14.50€
Juego de 10 buriles

Aplicable a los modelos:

JAG-0903/ JAG-0906/ JAG-0913/ JAG-0923/ JAG-0925/ JAG-0955

JAG-0906RMK
91.00€
Esmeriladora recta neumática de 1/4" con kit de accesorios
Características:

Revoluciones en vacío:	22 000rpm
Capacidad de la pinza:	6mm
Potencia:	0,4Kw
Longitud:	175mm
Peso:	490g
Diámetro interior:	10mmø

Accesorios:

Buriles: 6mm (1/4")
Buriles: 3mm (1/8")
Llaves
Reducción: 3mm (1/8")
Maleta

JAG-0906R/RM-RK
8.10€
Kit de reparación para JAG-0906RMK

JAG-0913RMK
111.00€
Esmeriladora neumática angular de 1/4" con kit de accesorios
Características:

Revoluciones en vacío:	18 000rpm
Capacidad de la pinza:	6mm
Potencia:	0,21Kw
Longitud:	155mm
Peso:	490g
Diámetro interior:	10mmø

Accesorios:

Buriles: 6mm (1/4")
Buriles: 3mm (1/8")
Llaves
Reducción: 3mm (1/8")
Maleta

JAG-0913RM-RK
5.60€
Kit de reparación para JAG-0913RMK

JAG-0923RM

54.00€

Mini esmeriladora recta neumática de 1/4"

Características:

Revoluciones en vacío: 25 000rpm
 Capacidad de la pinza: 6mm
 Potencia: 0,5hp
 Longitud: 170mm
 Peso: 700g
 Consumo del aire: 76l/min
 Presión operacional: 6,2bar
 Ruido: 97dB



JAG-0923RM-RK

6.30€

Kit de reparación para JAG-0923RM



JAG-0925RM

57.00€

Esmeriladora recta neumática de 1/4"

Características:

Revoluciones en vacío: 22 000rpm
 Capacidad de la pinza: 6mm
 Potencia: 0,5hp
 Longitud: 170mm
 Peso: 700g
 Consumo del aire: 113l/min
 Presión operacional: 6,2bar
 Ruido: 97dB



JAG-0925RM-RK

19.50€

Kit de reparación para JAG-0925RM



JAG-0955RM

90.00€

Esmeriladora recta neumática de 1/4"

Características:

Revoluciones en vacío: 22 000rpm
 Capacidad de la pinza: 6mm
 Potencia: 0,5hp
 Longitud: 260mm
 Peso: 700g
 Consumo del aire: 113l/min
 Presión operacional: 6,2bar
 Ruido: 97dB



JAG-0955RM-RK

7.60€

Kit de reparación para JAG-0955RM



JAG-1087

157.00€

Micro rectificadora neumática

Características:

Revoluciones en vacío: 60 000rpm
 Boca: 3mm
 Diámetro interior: 10mmø
 Peso: 220g
 Consumo del aire: 180l/min
 Dimensiones: 17x120mm



JAG-1087-RK

31.00€

Kit de reparación para JAG-1087



JAG-6638

173.00€

Amoladora neumática angular de 125mm

Características:

Revoluciones en vacío: 11 000rpm
 Dimensión del disco: 125mm
 Potencia: 0,7Kw
 Longitud: 230mm
 Peso: 1 800g
 Dimensión del disco: 10mmø
 Vibración mango: 6,45m/s²
 Ruido: 86dB



JAG-6638-RK

70.00€

Kit de reparación para JAG-6638



JAG-6638-DC

2.00€

Disco de corte

Medida: 125mm

JAG-6638-DR

3.20€

Disco de amolar

Medida: 125mm

JAG-6639

320.00€

Amoladora neumática angular de 180mm

Características:

Revoluciones en vacío: 7 000rpm
 Dimensión del disco: 180mm (7")
 Potencia: 1,4Kw
 Longitud: 343mm
 Peso: 3 100g
 Diámetro interior: 10mmø



JAG-6639-RK

95.00€

Kit de reparación para JAG-6639



JAG-6639-DC

3.10€

Disco de corte

Medida: 180mm

JAG-6639-DR

6.00€

Disco abrasivo

Medida: 180mm

JAS-6505

170.00€

Pulidora de ángulo de 180mm

Características:

Revoluciones en vacío: 4 500rpm
 Dimensión del disco: 178mm
 Rosca del eje: 5,8" (11UNC)
 Longitud: 406mm
 Peso: 2 500g
 Diámetro interior: 10mmø



JAS-6505-RK

6.30€

Kit de reparación para JAS-6505



JAS-6551

150.00€

Pulidora de ángulo de 180mm

Características:

Revoluciones en vacío: 2 500rpm
 Dimensión del disco: 178mm
 Rosca del eje: 5,8" (11UNC)
 Longitud: 406mm
 Peso: 2 500g
 Diámetro interior: 10mmø



JAS-6551-RK

6.20€

Kit de reparación para JAS-6551



JAS-6552

145.00€

Pulidor neumático de 180mm

Características:

Revoluciones en vacío: 2 500rpm
 Dimensión del disco: 178mm
 Peso: 2 800g
 Diámetro interior: 10mmø
 Consumo del aire: 260l/min



JAS-6552-RK

18.00€

Kit de reparación para JAS-6552



JAS-0010

255.00€

Lijadora con patín triangular y base en vinilo

Características:

Revoluciones en vacío: 9 000rpm
 Dimensión de la base: 93x132mm
 Diámetro interior: 10mmø
 Consumo del aire: 260l/min



JAS-0010-RK

23.50€

Kit de reparación para JAS-0010



JAS-0010-41

21.00€

Base para lijadora JAS-0010

Dimensión de la base: 93x132mm



JAS-0413

130.50€

Lijadora orbital angular

Máquina de composite.

Características:

Revoluciones en vacío: 15 000rpm
 Dimensión del disco: 76mm
 Orbite: 3mm
 Motor: 0,4cv
 Longitud: 125mm
 Peso: 720g
 Diámetro interior: 10mmø
 Consumo del aire: 99l/min
 Vibración: 6,3m/s²
 Ruido: 80dB



JAS-0413-RK

11.00€

Kit de reparación para JAS-0413



JAS-0423K

172.00€

Pulidora angular

Máquina de composite.

Características:

- Revoluciones en vacío: 2 100rpm
- Dimensión del disco: 76mm
- Motor: 0,4cv
- Longitud: 135mm
- Peso: 770g
- Consumo del aire: 99l/min
- Presión operacional: 6,2bar
- Vibración: 2,3m/s²
- Ruido: 78dB



JAS-0423-RK

24.50€

Kit de reparación para JAS-0423



JAS-0423-31

12.00€

Base en velcro para JAS-0423



JAS-1021-6HE(2.5)

222.00€

Lijadora orbital angular con base en vinilo adhesivo con 6"

Máquina de composite.

Características:

- Revoluciones en vacío: 12 000rpm
- Dimensión del disco: 150mm
- Diámetro: 2,5mm
- Peso: 960g
- Diámetro interior: 10mmø
- Consumo del aire: 170l/min



JAS-1021-6HE-RK

10.50€

Kit de reparación para JAS-1021-6HE

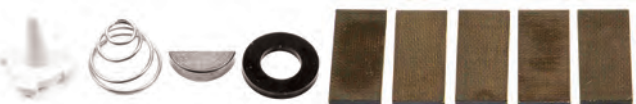

JAS-1206-6HE

350.00€

Lijadora orbital para conexión con central de aspiración con base en vinilo adhesivo con 6"

Máquina de composite.

Características:

- Revoluciones en vacío: 12 000rpm
- Dimensión del disco: 150mm
- Diámetro: 5mm
- Diámetro interior: 10mmø



JAS-1206-6HE-RK

47.00€

Kit de reparación para JAS-1206-6HE



JAS-1206-6HP

53.00€

Base en velcro para lijadora JAS-1206/ JAS-1207 con 6"



JAS-1207-6HE

390.00€

Lijadora orbital con auto-aspiración con base en vinilo adhesivo con 6"

Máquina de composite.

Características:

- Revoluciones en vacío: 12 000rpm
- Dimensión del disco: 150mm
- Diámetro: 5mm
- Diámetro interior: 10mmø



JAS-1207-6HE-RK

47.00€

Kit de reparación para JAS-1207-6HE



JAS-1207-6HE-56

29.00€

Bolsa de tejido para protección de la bolsa papel para recogida de polvo para JAS-1207-6HE



JAS-1207-6HE-57 3.60€

Bolsa en papel para recogida de polvo para JAS-1207-6HE



JAS-1206-6HP 53.00€

Base con velcro para lijadora JAS-1206/ JAS-1207 con 6"



JAS-1031-6HE 228.00€

Lijadora orbital con base en velcro con 6"

Máquina de composite.

Características:

Revoluciones en vacío: 10 000rpm
 Dimensión del disco: 150mm
 Diámetro: 5mm
 Peso: 1 040g
 Diámetro interior: 10mmø



JAS-1031-6HE-RK 51.00€

Kit de reparación para JAS-1031-6HE

JAS-1031-6VE-RK 50.00€

Kit de reparación para JAS-1031-6VE

JAS-1031-6HP 25.00€

Base en velcro para lijadora JAS-1031/ JAS 6535-6HE



JAS-6531 147.00€

Lijadora rectangular estrecha

Máquina de composite.

Características:

Movimientos/ minuto: 2 500
 Dimensión de la base: 63,5x407mm
 Longitud: 406mm
 Peso: 3 100g
 Diámetro interior: 10mmø
 Consumo del aire: 226l/min
 Ruído: 93,3dB



JAS-6531-RK 2.80€

Kit de reparación para JAS-6531

JAS-6531-LIXA 53.00€

Rodillo de lijado de pantalla flexible

JAS-6535-5HE 205.00€

Lijadora orbital con base en velcro con 5"

Máquina de composite.

Características:

Revoluciones en vacío: 10 000rpm
 Dimensión del disco: 125mm
 Diámetro: 5mm
 Peso: 1 040g
 Diámetro interior: 10mmø



JAS-6535-5HE-RK 53.00€

Kit de reparación para JAS-6535-5HE

JAS-6535-5HE-47 21.00€

Base en velcro para JAS-6535-5HE



JAS-6535-5VE-RK 39.00€

Kit de reparación para JAS-6535-5VE

JAS-6535-6HE 205.00€

Lijadora orbital con base en velcro con 6"

Máquina de composite.

Características:

Revoluciones en vacío: 10 000rpm
 Dimensión del disco: 150mm
 Diámetro: 5mm
 Peso: 1 040g
 Diámetro interior: 10mmø



JAS-6535-6HE-RK 50.00€

Kit de reparación para JAS-6535-6HE

JAS-1031-6HP 25.00€

Base en velcro para lijadora JAS-1031/ JAS 6535-6HE



JA-6111(1.4) 114.00€

Pistola de pintura tipo gravedad

Características:
 Entrada de aire: 1/4"
 Capacidad del vaso: 600 ml
 Boquilla estándar: 1,4mm



JA-6111

Kit boquilla para pistola JA-6111

Ref.	Medida (mm)	Precio
JA-6111-NS	1.3	45.00€
JA-6111-NS17	1.7	45.00€
JA-6111-NS20	2	45.00€

JA-6111K 250.00€

Juego de pistola de pintura tipo gravedad y accesorios

Características:
 Pistola: JA-6111
 Capacidad vaso nylon: 250 y 600 ml
 Boquilla: 1,7 y 2mm
 Diámetro interior: 10mmø
 Kit de limpieza
 Maleta



JA-HVLP-1080GK 300.00€

Juego de pistola de pintura HVLP y accesorios

Características:
 Pistola: JA-HVLP-1 080G
 Capacidad vaso nylon: 250 y 600ml
 Boquilla: 1,4; 1,7 y 2mm
 Diámetro interior: 10mmø
 Kit de limpieza
 Maleta



JA-HVLP-1080GD-N1.4 62.00€

Boquilla de 1.4 para pistola JA-HVLP-1 080GD

JA-HVLP-300C (1.3) 185.00€

Pistola de pintura tipo gravedad

Características:
 Entrada de aire: 1/4"
 Capacidad vaso nylon: 600 ml
 Boquilla estándar: 1,3mm
 Presión del aire: 2bar
 Consumo del aire: 481l/min
 Peso: 545g
 Diámetro interior: 10mmø



JA-HVLP-3000-NS17 72.00€

Kit boquilla 1.7 para pistola de pintura

JA-HVLP-3000-NS19 72.00€

Kit boquilla 1.9 para pistola de pintura

JA-300C-NS13 71.00€

Boquilla completa 1.3 para pistola de pintura JA-HVLP3000/ JA-HVLP300C

JA-LVLP-0303W 179.00€

Pistola de pintura para tintas a base de agua tipo gravedad

Características:
 Entrada de aire: 1/4"
 Capacidad vaso nylon: 600 ml
 Boquilla estándar: 1,3mm
 Diámetro interior: 10mmø



JA-LVLP-0303W-N 58.00€

Kit boquilla 1.3 para pistola de pintura

JA-LVLP-0303W-N18 58.00€

Kit boquilla 1.8 para pistola de pintura

JA-HVLP-6112 175.00€

Pistola de pintura tipo gravedad

Características:
 Entrada de aire: 1/4"
 Capacidad vaso nylon: 125 ml
 Boquilla estándar: 1mm
 Presión del aire: 3bar
 Consumo del aire: 112l/min
 Peso: 240g
 Diámetro interior: 10mmø



ACC-609

23.00€

Regulador de aire 0-10 bar

JA-3806C

11.50€

 Regulador de presión para pistola de pintura
 Aplicable a la pistola JA-HVLP-6112

JA-3808A

11.00€

Separador agua/sustancias aceitosas para pistolas de pintura

JA-0001RK

6.00€

Kit de reparación para pistola de pintura

AS-0026

15.50€

Kit de limpieza para pistolas de pintura con 12 piezas

AS-0013A2

28.50€

 Vaso de aluminio para pistola de pintura tipo gravedad
 Capacidad: 600ml

AS-001

Vaso para pistola de pintura

Ref.	Capacidad (ml)	Precio
AS-0013	600	15.50€
AS-0015	125	10.00€

JA-300C-28

14.60€

Vaso para pistola de pintura JA-HVLP-3000

 Capacidad: 600ml
 Funda no incluida

AS-001

Caperuza para vaso de pistola de pintura

Ref.	Capacidad (ml)	Precio
AS-0013C	600	4.50€
AS-0015C	250	4.50€

JA-950

79.00€

Pistola de secado para tintas a base de agua

JA-950-04

3.50€

Filtro de malla para pistola JA-950

JA-960

220.00€

 Soporte para 2 pistolas de secado
 No se incluyen las pistolas

JAS-0452

215.00€

Lijadora de banda ancha

Máquina de composite.

Características:

Revoluciones en vacío:	16 000rpm
Dimensión de la base:	20x520mm
Longitud:	430mm
Peso:	1 400g
Diámetro interior:	10mmø
Consumo del aire:	113l/min
Vibración:	2,8m/s ²
Ruido:	95dB



JAS-0452-RK 39.50€

Kit de reparación para JAS-0452

JAS-6542 205.00€

Lijadora de banda ancha

Características:

- Revoluciones en vacío: 16 000rpm
- Dimensión de la base: 20x520mm
- Longitud: 360mm
- Peso: 1 200g
- Diámetro interior: 10mmø



JAS-6542-RK 28.00€

Kit de reparación para JAS-6542

JAS-6543 125.00€

Lijadora de banda estrecha

Características:

- Revoluciones en vacío: 16 000rpm
- Dimensión de la base: 10x330mm
- Longitud: 290mm
- Peso: 800g
- Longitud: 10mmø



JAS-6543-RK 22.50€

Kit de reparación para JAS-6543

JAT-1020K 285.00€

Sierra/ lima neumática baja vibración con kit accesorios

Mecanismo de baixa vibração

Características:

- Oscilación por minuto: 16 000bpm
- Curso: 25mm
- Peso: 960g
- Diámetro interior: 10mmø



Accesorios:



Cuchillas: T14; T18 y T24
Limas
Maleta

JAT-1020-RK 62.00€

Kit de reparación para JAT-1020

JAT-12F

Limas para JAT-1020

Ref.	Forma	Precio
JAT-12F1	triangular	6.50€
JAT-12F2	media caña	7.00€
JAT-12F3	redonda	6.80€
JAT-12F4	plana	6.40€



JAT-20T

Sierras para JAT-1020

Ref.	Dientes	Precio
JAT-20T14	14	4.70€
JAT-20T18	18	4.70€
JAT-20T24	24	4.70€



JAT-1041 180.00€

Pulidor neumático de válvulas

Características:

- Oscilación por minuto: 3 000bpm
- Capacidad máxima: 4,5mmø
- Longitud: 153,5mm
- Peso: 1 550g
- Diámetro interior: 10mmø
- Consumo del aire: 100l/min
- Ventosas: 16; 20; 30 y 35mm



JAT-1041-16S 24.00€

Juego de 4 ventosas para JAT-1041

Características:

Medidas: 16; 20; 30 y 35mm



JAT-1011 160.00€

Sierra neumática de baja vibración

Características:

- Oscilación por minuto: 11 000bpm
- Curso: 8mm
- Peso: 450g
- Diámetro interior: 10mmø
- Consumo del aire: 90l/min
- Ruido: 86,8dB



JAT-1011-RK 27.50€

Kit de reparación para JAT-1011

JAT-6613

210.00€

Máquina neumática de decapar

Características:

Diámetro de la base: 105mm
 Revoluciones en vacío: 3.500 rpm
 Entrada de aire: 1/4"
 Dimensiones (long/alt): 203x106mm
 Peso: 960g
 Consumo de aire: 280l/min
 Ruido: 98dB

JAT-6613-P

15.80€

Disco de goma para JAT-6613

JAT-6613-PA

16.00€

Disco abrasivo de limpieza para JAT-6613

JAT-6613-RK

28.50€

Kit de reparación para JAT-6613
JAT-6676

133.00€

Sierra neumática

Características:

Capacidad del corte: 1,6mm (espesor acero)
 Oscilación por minuto: 10 000bpm
 Curso: 10mm
 Longitud: 235mm
 Peso: 960g
 Diámetro interior: 10mmø

JAT-6676-RK

7.50€

Kit de reparación para JAT-6676
JAT-10T

Sierras para JAT-6676 5 unidades

Ref.	Dientes	Longitud (mm)	Precio
JAT-10T18	18	75	15.50€
JAT-10T32	32	75	15.90€

JAT-6421

50.00€

Máquina de corte neumático de discos con 3"

Características:

Revoluciones en vacío: 20 000rpm
 Peso: 1 040g
 Diámetro interior: 10mmø

JAT-6421-RK

2.70€

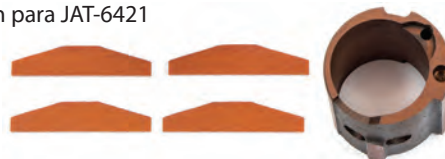
Kit de reparación para JAT-6421

JAT-6421-33

2.10€

Disco de sierra para JAT-6421
JAT-6441K

140.00€

Cuchilla neumática con kit de accesorios

Características:

Oscilación por minuto: 22 000bpm
 Longitud: 120mm
 Peso: 1 200g
 Diámetro interior: 10mmø



Accesorios:

Cuchillas: 30; 35 y 57mm
 Maleta

JAT-6441-RK

2.00€

Kit de reparación para JAT-6441
CF-K
Cuchillas para JAT-6441K

Ref.	Longitud (mm)	Precio
CF-K-C	35	10.70€
CF-K-E	57	9.00€
CF-K-F	90	22.70€
CF-K-G	24	13.50€
CF-K-I	36	17.50€
CF-K-J	63	20.00€



JAT-6443K 180.00€

Herramienta de corte por oscilación

Características:

Amplitud de corte: 3mm
 Potencia: 0,3cv
 Oscilación por minuto: 20 000bpm
 Longitud: 180mm
 Peso: 700g
 Consumo de aire: 54l/min
 Ruido: 95dB



Accesorios: 8 accesorios de corte

JAT-6443-RK 14.00€

Kit de reparación para JAT-6443



JAT-6443-K

Accesorios de corte JAT-6443

Ref.	Cuchilla	Longitud (mm)	Precio
CF-K-E	Corte	57	9.00€
JAT-6443-K1	Corte nivelado	10	5.70€
JAT-6443-K2	Corte nivelado	20	5.70€
JAT-6443-K3	Corte nivelado	30	6.50€
JAT-6443-K4	Raspadora	51	5.70€
JAT-6443-K5	Lijadora triangular	80	7.80€
JAT-6443-K6	HSS media luna	88	23.00€
JAT-6443-K7	Media luna desbaste	64	11.50€



JAT-6952 95.50€

Tijera neumática recta

Características:

Oscilación por minuto: 2 300/ 2 500bpm
 Capacidad del corte: 1,2mm (espesor acero)
 Tamaño do corte: 5,5mm
 Longitud: 255mm
 Peso: 1 000g
 Diámetro interior: 10mmø



Accesorios:

Cuchillas: 30; 35 y 57mm

JAT-6952-RK 2.00€

Kit de reparación para JAT-6952

JAT-6952P 110.00€

Tijera neumática

Características:

Oscilación por minuto: 2 200bpm
 Capacidad del corte: 1,2mm (espesor acero)
 Tamaño do corte: 5,5mm
 Longitud: 215mm
 Peso: 1 200g
 Diámetro interior: 10mmø



JAT-6952P-RK 2.00€

Kit de reparación para JAT-6952P

JAT-6952P

Cuchillas para JAT-6952/P

Ref.	Cuchillas	Precio
JAT-6952P-37	izquierda	11.00€
JAT-6952P-39	central	13.00€
JAT-6952P-40	derecha	11.00€

JAT-6943A 118.00€

Alicate neumático de rebajos

Características:

Capacidad del corte: 1,4mm
 Capacidad de rebajo: 8mm
 Dobra: 12mm
 Longitud: 248mm
 Peso: 1 300g
 Diámetro interior: 10mmø



JAT-6943A-RK 9.30€

Kit de reparación para JAT-6943A

JAT-6412 76.00€

Amoladora neumática

Características:

Velocidad de corte: 3 200rpm
 Capacidad del corte: 1,4mm (espesor acero)
 Longitud: 210mm
 Peso: 1 000g
 Diámetro interior: 10mmø



JAT-6412-RK 2.00€

Kit de reparación para JAT-6412

JAH-0288 119.00€

Martillo neumático de agujas

Características:
 Golpes por minuto: 5 000
 Número de agujas: 12
 Longitud: 290mm
 Peso: 1 200g
 Consumo del aire: 90l/min
 Diámetro interior: 10mmø

JAH-0288-15 15.30€

Cinzel para JAH-0288
JAH-0288-16 7.90€

Juego de agujas para JAH-0288
JAH-0288-17 5.90€

Alojamiento de agujas para JAH-0288
JAH-0288-RK 25.50€

Kit de reparación para JAH-0288
JAH-308HK 188.00€

Martillo neumático de baja vibración

Características:
 Encaje hexagonal
 Carrera del pistón: 64mm
 Golpes por minuto: 3 000
 Longitud: 230mm
 Peso: 2 000g
 Consumo de aire: 170l/m



Acessórios:
 5 accesorios
 Maleta

JAH-308HK-RK 7.50€

Kit de reparación para JAH-308H

JAH-6837 162.00€

Martillo tallador recto

Características:
 Golpes por minuto: 4 600
 Encajadura: 25,4x43,5
 Longitud: 380mm
 Peso: 2 100g
 Diámetro interior: 10mmø

JAH-6837-RK 21.00€

Kit de reparación para JAH-6837
JAH-6837-5
Cinzel para JAH-6837

Ref.	Tipo	Longitud. (mm)	Precio
JAH-6837-50	plan	35-175	18.50€
JAH-6837-50-2	puntero		18.80€

JAH-7104H

413.00€

Martillo neumático de 1"

Características:
 Golpes por minuto: 2 820
 Longitud: 308mm
 Peso: 5 500g
 Consumo del aire: 228l/min
 Diámetro interior: 10mmø

JAH-7104H-RK

6.50€

Kit de reparación para JAH-7104H
JAZ-01
Buril hexagonal

Ref.	Tipo	Precio
JAZ-011H	boquilla	23.00€
JAZ-016H	punta	23.00€

JAT-6034

113.00€

Remachadora neumática

Características:
 Capacidad: 2,4 a 4,8mm (acero+acero inoxidable)
 Potencia: 10 250Nm
 Carrera de tracción: 16mm
 Longitud: 308mm
 Peso: 1 500g
 Diámetro interior: 10mmø

JAT-6034-RK

26.00€

Kit de reparación para JAT-6034

JAT-6034
Boquillas remachadoras JAT-6034

Ref.	Diámetro (mm)	Precio
JAT-6034-1A	4,8	1.25€
JAT-6034-1B	4	1.25€
JAT-6034-1C	3,2	1.25€
JAT-6034-1D	2	1.25€



JAT-6673

340.00€

Remachadora neumática

Características:
 Capacidad: 2,4 a 6,4mm (acero+aço inox.)
 Carrera de tracción: 18mm
 Peso: 1 750g
 Consumo del aire: 2,9l/ciclo
 Diámetro interior: 10mmø



JAT-6673-RK

59.50€

Kit de reparación para JAT-6673

JAT-1035

485.00€

Remachadora neumática de remaches hembra

Características:
 Dimensiones: 270x190mm
 Capacidad: M4-M10 (acero)
 Capacidad: M4-M8 (acero inox.)
 Carrera de tracción: 6mm
 Peso: 1 550g
 Consumo del aire: 1,5l/ciclo
 Diámetro interior: 10mmø



JAT-1035-RK

7.80€

Kit de reparación para JAT-1035

JAT-460

31.00€

Bomba de engrase palanca

Actuación por palanca
 Capacidad: 400cc



JAT-481

46.00€

Bomba de engrase palanca

Actuación por pistola
 Capacidad: 400cc



JAT-480-NS

10.40€

Adaptador flexible para JAT-480



JAT-6004K

75.00€

Bomba neumática de boquilla dura de engrase con accesorios

Palanca de accionamiento manual
 Capacidad: 400cc

Accesorios:



Cuadradillo flexible
 Alavanca por accionamiento manual



JAT-501

65.00€

Pistola neumática para masilla

Características:
 Entrada: 1/4"
 Capacidad: 310mml
 Presión: 2,5 a 5,1bar
 Diámetro interior: 10mmø
 Cartucho en forma de cono



JA-5032

37.00€

Pistola neumática para masilla

Características:
 Presión: 2 a 4bar
 Longitud: 330mm
 Peso: 1 225g
 Consumo del aire: 170l/min
 Diámetro interior: 10mmø
 Material: metal



JAZ-3811E

67.00€

Balanza

Características:
 Capacidad de carga: 3 a 5kg
 Longitud del cable: 1,5kg
 Diámetro del cable: 3,2mm



JA-3812A

44.00€

Balanza

Características:
 Capacidad de carga: 0,5kg
 Longitud del cable: 1,6m
 Diámetro del cable: 1,8mm
 Peso: 560g



JA-3812D

46.00€

Balanza

Características:
 Capacidad de carga: 3 a 5kg
 Longitud del cable: 1,6m
 Diámetro del cable: 1,8mm
 Peso: 560g



JAT-6904S

19.00€

Pistola para agua con kit de accesorios con 5 boquillas

JAT-6905B

18.00€

Pistola para aire

JAT-6905S

35.00€

Pistola de aire con conjunto de accesorios

JAT-6905-C

3.40€

Boquilla para pistola de aire
 Boquilla triangular extendida

JAT-6905-J

12.60€

Boquilla para pistolette de aire
 Boquilla con cepillo en nylon

JAT-6959

6.80€

Pistola de aire con boquilla larga

 Longitud: 100mm
 Presión de trabajo: 75-120psi
 Ruido: 85-90dba
 Hembra: 1/4"

JAT-6959A

8.30€

Pistola de aire con boquilla larga de 1/4"

 Longitud: 280mm
 Presión de trabajo: 75-120psi
 Ruido: 85-90dba
 Hembra: 1/4"

Accesorios para redes de aire comprimido
JAZ-000

Enrollador aire

Ref.	Manguera ø (mm)	Manguera longit. (m)	Precio
JAZ-0001B	8x12	15	150.00€
JAZ-0002A	8x12	9	111.00€
JAZ-0002B	9,5x13,3	7,5	104.00€
JAZ-0002C	6,5x10	10	110.00€

JAZ-39520

198.00€

Enrollador móvill para aire de 3/8"

 Longitud: 20m
 Presión máxima: 15bar
 Peso: 7 000g
 Interior manguera: 9,5mmø
 Enlace: 3/8"

JA-725

Mini lubricante aceite para máquinas neumáticas

Ref.	Medida	Precio
JA-7253	1/4"	7.90€
JA-7254	3/8"	11.50€

JAZ-0042

16.00€

Cardan para máquinas neumáticas de 14"

JAZ-0513

Copa plástico para filtros lubricante JAZ-0512/ JAZ-0513

Ref.	Especif.	Precio
JAZ-0514-06	purga	2.50€
JAZ-0513-09	copo aire	5.20€
JAZ-0514-13	freio	0.35€
JAZ-0513-50	aceite	5.20€

JAZ-0514

Copa plástico para filtros lubricante JAZ-0514/ JAZ-0515

Ref.	Especif.	Precio
JAZ-0514-06	purga	2.50€
JAZ-0514-09	copo aire	9.80€
JAZ-0514-13	freio	0.35€
JAZ-0514-48	copo aceite	7.00€



JAZ-051

Filtro lubricante con regulador de presión



Ref.	Entrada	Flujo (l/min)	Presión (bar)	Filtro (uni.)	Precio
JAZ-0512	1/4"	1 000	0,5-8,5	5	76.50€
JAZ-0513	3/8"	1 350	0,5-8,5	5	83.00€
JAZ-0514	1/2"	3 000	0,5-8,5	5	112.00€
JAZ-0516	3/4"	3 100	0,5-8,5	5	122.00€

Nota: La presión máxima de alimentación es de 8.5bar

JAZ-6704A

Filtro lubricante con regulador de presión



Entrada	Flujo (l/min)	Presión (bar)	Filtro (uni.)	Precio
1/2"	1 250	1-10	5	110.00€

JAZ-6710A

Filtro de aire 1/2"

43.00€



JAZ-6711A

Regulador de presión 1/2"

53.50€



JAZ-6712A

Lubricador del aire 1/2"

44.00€



JAZ-6715A

Filtro de aire con regulador 1/2"

71.00€



JAZ-6704

Copa plástico para filtros lubricadores JAZ-6704A/ JAZ-6710A

Ref.	Especif.	Precio
JAZ-6704-W	ar	10.40€
JAZ-6704-O	aceite	5.50€

JAZ-7214

Extensor en espiral hembra de 1/4"



Ref.	Medida (mm)	Longitud (m)	Precio
JAZ-7214F	5x8	13	26.00€
JAZ-7214S	6,5x10	13	31.00€
JAZ-7214Z	8x12	15	52.50€

GM-0

Racor hembra



Ref.	Medida	Precio
GM-02AF	1/4"	6.50€
GM-03AF	3/8"	6.90€
GM-04AF	1/2"	7.20€

GM-0

Racor macho



Ref.	Medida	Precio
GM-02AM	1/4"	6.80€
GM-03AM	3/8"	6.50€
GM-04AM	1/2"	7.00€

GM-0

Racor tubo



Ref.	Medida	Precio
GM-02AH	1/4"	7.00€
GM-03AH	3/8"	7.40€
GM-04AH	1/2"	7.30€
GM-02BH	5/16"	7.50€

GM-0

Punta hembra

Ref.	Medida	Precio
GM-02PF	1/4"	1.30€
GM-03PF	3/8"	2.30€
GM-04PF	1/2"	2.70€



GM-0

Punta macho

Ref.	Medida	Precio
GM-02PM	1/4"	1.20€
GM-03PM	3/8"	2.10€
GM-04PM	1/2"	2.50€



Accesorios para redes de aire comprimido

GM-0

Punta de espiga

Ref.	Medida	Precio
GM-02PH	1/4"	1.40€
GM-03PH	3/8"	1.40€
GM-04PH	1/2"	1.70€
GM-02BPH	5/16"	1.40€



KIT AR

58.00€

Juego de accesorios de unión a red de aire

Composición:

- GM-02AF Racor hembra de 1/4"
- GM-02PF Punta hembra de 1/4"
- GM-02PM Punta macho de 1/4"
- JAT-6905B Pistola simple para aire
- JAZ-7214S Extensor en espiral 13m





JONNESWAY®

Herramientas Profissionais

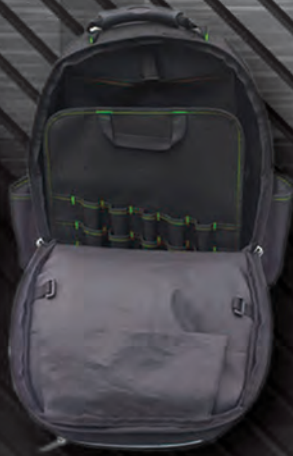



JONNESWAY®

Merchandising



Merchandising

BOUTJW01A-M 12.35€

BOUTJW01A-L 12.35€

BOUTJW01A-XL 12.35€

Camiseta negra

Con logotipo de Jonnesway impreso en el pecho y la manga, en los tamaños M, L y XL.



BOUTJW02A 8.50€

Gorra tipo béisbol negra

Con logotipo de Jonnesway bordado.



JW-01B 18.00€

Gorra tipo béisbol negra

Con logotipo de Jonnesway bordado.



BOUTJW03B 38.50€

Bolígrafo 50 unidades

Con logotipo de Jonnesway.



BOUTJW04A-M 35.50€

BOUTJW04A-L 35.50€

BOUTJW04A-XL 35.50€

Polar beige

Con logotipo de Jonnesway bordado en el pecho, en los tamaños M, L y XL.



BOUTJW05A 23.00€

Paraguas negro 1 unidad

Con logotipo de Jonnesway impreso.



BOUTJW06B 30.00€

Lona Jonnesway

Medidas: 1 480x890mm



BOUTJW07A-M 18.50€

BOUTJW07A-L 18.50€

BOUTJW07A-XL 18.50€

Polo negro

Con logotipo de Jonnesway bordado en el pecho, en los tamaños M, L y XL.



BOUTJW07B-M 25.50€

BOUTJW07B-L 25.50€

BOUTJW07B-XL 25.50€

Polo negro

Con logotipo de Jonnesway bordado en el pecho, en los tamaños M, L y XL.



BOUTJW08B-50 65.00€

BOUTJW08B-52 65.00€

BOUTJW08B-54 65.00€

Mono mecánico gris

Con logotipo de Jonnesway impreso en el pecho y en espalda.



JW-USB 17.00€

Dispositivo de almacenamiento de datos - pen USB 1 unidad
Capacidad: 16 Gb



BOUTJW13A 7.50€

Parasol

Con logotipo de Jonnesway.



Merchandising

BOUTJW14B 24.50€

Mochila

Con logotipo de Jonnesway bordado.
Dimensiones: 280x380x120mm



JW-BACKPACK 105.00€

Mochila



BOUTJW15B 81.00€

Bolígrafo "touch" 50 unidades
Con logotipo de Jonnesway.



BOUTJW16A 3.40€

Llavero 1 unidad



BOUTJW17A-1 4.30€

Etiqueta Jonnesway

Dimensiones: 70x400mm



BOUTJW17A-2 10.80€

Etiqueta Jonnesway

Dimensiones: 100x600mm



BOUTJW18A 5.20€

Bolígrafo

Con logotipo de Jonnesway.



BOUTJW19A 40.00€

Bolígrafo "roller ball"
Con logotipo de Jonnesway.



BOUTJW20A-M 28.00€

BOUTJW20A-L 28.00€

BOUTJW20A-XL 28.00€

Sweat shirt

Con logotipo de Jonnesway bordado en el pecho.



BOUTJW21A-M 73.00€

BOUTJW21A-L 73.00€

BOUTJW21A-XL 73.00€

Chaleco

Con logotipo de Jonnesway bordado en el pecho.



BOUTJW22A-M 65.00€

BOUTJW22A-L 65.00€

BOUTJW22A-XL 65.00€

Abrigo

Con logotipo de Jonnesway bordado en el pecho.



BOUTJW23A-M 51.00€

BOUTJW23A-L 51.00€

BOUTJW23A-XL 51.00€

Pantalones

Con logotipo de Jonnesway bordado.



BOUTJW24A 8.00€

Blocks de notas

Con logotipo de Jonnesway.
Dimensiones: 140x210mm



BOUTJW25B 40.50€

Carpeta A4

Con logotipo de Jonnesway impreso.
Dimensiones: 245x325x40mm



BOUTJW26A 73.00€

Maleta para portátil

Con logotipo de Jonnesway impreso.
Dimensiones: 410x300x80mm



BOUTJW27A

27.50€

Ratón inalámbrico
Con logotipo de Jonnesway.



BOUTJW28A

23.00€

Base cargadora por inducción para teléfonos móviles
Dimensiones: 69x10mm

Especificaciones:

Cargador de inducción con una potencia de carga de hasta 10w.
Incluye un cable USB/micro USB para la conexión de la base.
Compatible con los smartphones con tecnología de carga inalámbrica.



BOUTJW29A

182.00€

Bandera de tiburón
Dimensiones: 660x2000mm



C-DSP

515.00€

Expositor de herramientas con paneles perforados y 30 ganchos

Medidas:

Altura: 2 140mm
Profundidad: 660mm
Ancho: 940mm



C-DSP-0WB10

1.30€

Gancho para expositor C-DSP

DS96

120.00€

Expositor vacío para destornilladores

Capacidad: 96 llaves
Dimensiones: 595x240x210mm



C-DS14

170.00€

Expositor para llaves vaso

Dimensiones: 350x420x350mm



JAZ-ST4

42.00€

Base en acrílico para máquinas neumáticas



FITA JW

4.00€

Cinta de embalaje Jonnesway



JW-OPENER

4.50€

Abrebotellas





JONNESWAY®

Herramientas Profissionais





JONNESWAY®

Otros Equipos

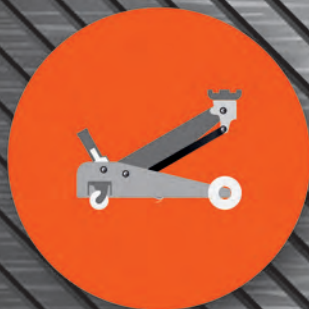

Otros equipos

AE020009

405.00€

Bomba hidroneumática

Operación presión: 690bar
 Alimentación: 7-10bar
 Dimensiones: 257,50x127x204,50mm
 Peso: 8 000g
 Capacidad: 1 660cc



AE060002

699.00€

Gato hidráulico para transmisiones

Altura máxima: 750mm
 Altura mínima: 200mm
 Capacidad: 1t
 Dimensiones: 865x480mm
 Peso: 60kg



AE060003

1 300.00€

Gato hidráulico para transmisiones

Altura máxima: 890mm
 Altura mínima: 165mm
 Capacidad: 1,5t
 Dimensiones: 1 105x652mm
 Peso: 130kg



AE070002A

540.00€

Gato hidráulico de foso

Altura máxima: 1 835mm
 Altura mínima: 1 035mm
 Capacidad: 600kg

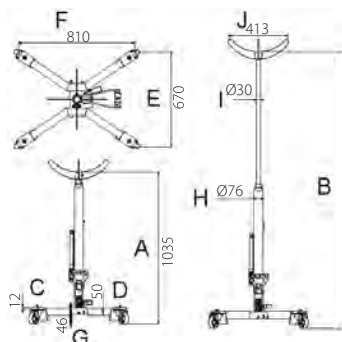

AE080001

690.00€

Gato de foso con plato universal

Altura máxima: 1 377mm
 Altura mínima: 880mm
 Capacidad: 500kg
 Plato: 729x597mm

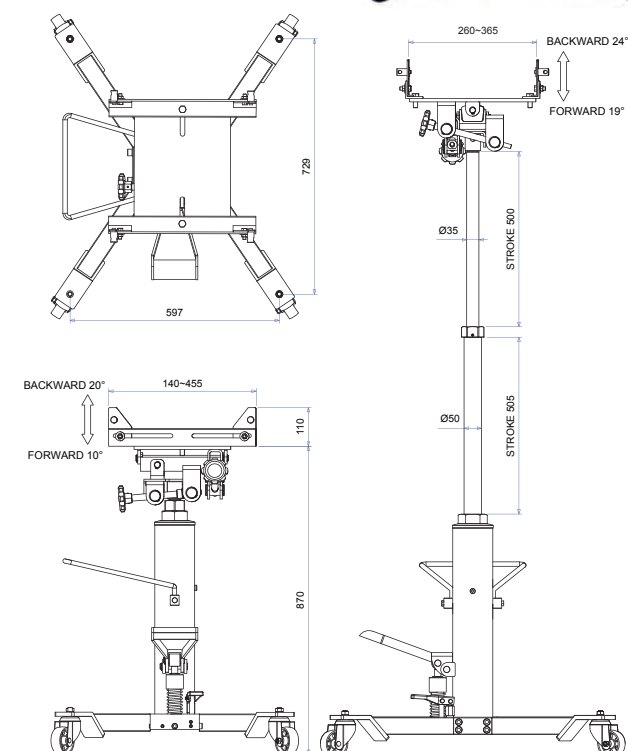

AG010236

65.00€

Soporte para mover neumáticos/ ruedas



AG010154

15.00€

Banco plástico de soporte con ruedas

Dimensiones: 450x335x310mm
Peso: 1 500g



AG010219

119.00€

Banco metálico con ruedas

Dimensiones: 350x260x240mm
Capacidad: 150kg

Incluye: Cajón
Soporte lateral piezas
Panel lateral apoyo



AG010222

84.00€

Banco metálico con ruedas

Dimensiones: 330x350x560mm
Capacidad: 130kg

Incluye: Cajón
Soportes laterales piezas



AE090105A

58.00€

Camilla para mecánico

Dimensiones: 1 000x470x130mm
Carga admisible: 120kg



AE110020

999.00€

Gato hidráulico

Altura máxima: 377mm
Altura mínima: 205mm
Capacidad: 20t

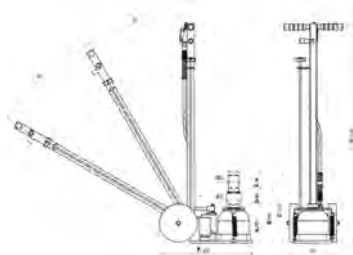

AE130003

960.00€

Grua hidráulica de 2t

Medidas en mm:
Altura mínima: 60
Elevación máxima: 2 330
Longitud de la base: 718-936
Longitud de la base: 1 606-2 426
Longitud máxima brazo: 1 960



AE130003-1

103.00€

Travesaño para soporte de motores para grúa

Capacidad: 500kg



AE140013

765.00€

Soporte de motores articulado

Capacidad: 600kg



AE150001

215.00€

Caballete

Altura: 710-1 065mm
Capacidad: 12t



AE150002

190.00€

Caballete

Altura: 456-710mm
Capacidad: 12t



AE170002

150.00€

Travesaño para soporte de motores

Ajuste: 530-1 480mm



AE010025A

340.00€

Gato hidráulico para chapistas de 4t

Composición:
Bomba hidráulica manual
Cilindro hidráulico: 4t (369-522mm)
Abrazadera de extensión
Adaptadores
Extensiones
Maletín con ruedas



AE010015A

540.00€

Gato hidráulico para chapistas de 10t

Composición:
Bomba hidráulica manual
Cilindro hidráulico: 10t (369-522mm)
Abrazadera de extensión
Adaptadores
Extensiones
Maletín con ruedas



AE050003

170.00€

Gato chapista 5t

Capacidad: 5t
Longitud: 750mm
Longitud del émbolo: 160mm



AE180001

245.00€

Barras para puertas

Longitud: 74-115mm



AE200003

1 180.00€

Porta ruedas de vehículos pesados

Capacidad: 600kg
Elevación: 395 mm



AE300149

157.00€

Recogedor de aceite

Recogedor ajustable en altura en polietileno de alta densidad con descarga por gravedad.

Capacidad: 50l
 Peso: 12kg
 Dimensiones: 550x550x990~1 070 mm



AR020016

91.00€

Multímetro digital y analizador auto

Funciones: RPM, dwell, volts AC/DC, amps DC, resistencia, ciclo de trabajo, temperatura, prueba de diodos, prueba continuidad.



AR020060

225.00€

Pinza amperimétrica

De conformidad con la norma IEC 1010 CAT III 1 000V

Multímetro digital con balanzas automáticas
 Multifunción para AC/DV amp; AC/DC V y Ohms
 Capacitancia, frecuencia y diodos
 Protección de sobrecarga
 Memoria
 RMS (valor eficaz)

Pinza amperimétrica: 2 000A - AC/DC
 Intervalo de medición: 2 000 A AC/400A DC



AR020061

169.00€

Multímetro digital

De conformidad con la norma IEC 1010 CAT III 1 000V

Pantalla grande
 Balanzas automáticas AC/DC para voltaje, amperaje, capacidad, frecuencia, resistencia
 Lectura hasta 10 Amp com protección y impedancia alta para lecturas de mV
 Memoria
 RMS (valor eficaz)



AR030067

40.00€

Medidor de voltaje multifuncional

Baterías no incluidas

Lectura de corriente AC/DC: 12-690V
 Pantalla LED/LCD



C-T4A

550.00€

Mesa de trabajo gris con 3 cajones

Cubierta metálica con cobertura en acrílico

Medidas:
 Altura: 800mm
 Profundidad: 700mm
 Ancho: 1 525mm



C-T5G-DP

118.00€

Panel trasero gris para banco de trabajo

Aplicación:
 Panel: C-T4A

Medidas:
 Altura: 700mm
 Ancho: 1 525mm



C-DBU1

1.60€

Gancho para panel trasero de banco de trabajo

Aplicación:
 Panel: C-T5G-DP
 Armoires: C-SA
 Longitud: 25,4mm



C-DBU7

1.80€

Gancho para panel perforado

Aplicación:
 Panel: C-T5G-DP
 Armarios: C-SA
 Longitud: 50,8mm



AB	Pág.						
AB010001	156	AB030076-28	162	AE300202	126	AE330015	159
AB010002	156	AB030076-30	162	AE300204	126	AE330016	159
AB010002-A	156	AB030076-32	162	AE300205	126	AE330030	159
AB010017	156	AB030076-34	162	AE300206	126	AE330034	159
AB010018	156	AB030089	158	AE300207	126	AE330035	160
AB010019	156	AB030094J	158	AE300211	126	AGO	Pág.
AB010020	156	AB030100	158	AE300212	123	AG010002	88
AB010026S	156	AC	Pág.	AE300215	127	AG010002S	88
AB010041	157	ACC-609	177	AE300220	127	AG010002SP	28
AB010043	157	AE0	Pág.	AE300221-02	140	AG010003	88
AB020002	157	AE010015A	193	AE300221-03	140	AG010005	88
AB020003	157	AE010025A	193	AE300221-04	140	AG010006	88
AB020009	157	AE020009	192	AE310002	123	AG010008	89
AB020010	157	AE040020	122	AE310003	159	AG010009	89
AB020015	157	AE050003	193	AE310006	123	AG010011	89
AB020019	157	AE060002	192	AE310008	123	AG010012	89
AB030001	157	AE060003	192	AE310010A	123	AG010023	159
AB030014	157	AE070002A	192	AE310013	123	AG010024	159
AB030028	157	AE080001	192	AE310014	123	AG010024-1	159
AB030041	157	AE090105A	192	AE310016	123	AG010024-2	159
AB030043	157	AE1	Pág.	AE310024	123	AG010026SP	28
AB030046	157	AE110020	192	AE310025	123	AG010030A	159
AB030047	157	AE130003	192	AE310026	123	AG010034	127
AB030048	157	AE130003-1	192	AE310027	123	AG010035	127
AB030056	122	AE140013	192	AE310034	124	AG010036	127
AB030060	158	AE150001	193	AE310035	124	AG010046	127
AB030061	122	AE150002	193	AE310037	124	AG010049	127
AB030068A	158	AE150005	122	AE310038	124	AG010055	159
AB030068C	158	AE170002	193	AE310062	124	AG010055-B	159
AB030068D	158	AE180001	193	AE310063	124	AG010059	127
AB030068F	158	AE2	Pág.	AE310066	124	AG010059-10	127
AB030069A	158	AE200003	193	AE310073	124	AG010059-12	127
AB030069B	158	AE3	Pág.	AE310077	124	AG010059-6	127
AB030069E	158	AE300064	122	AE310087	124	AG010059-8	127
AB030070B	158	AE300064-02	122	AE310099	124	AG010089	127
AB030070C	158	AE300064-03	122	AE310109A	125	AG010099	128
AB030070D	158	AE300064-04	122	AE310110	125	AG010109	128
AB030071	158	AE300064-05	122	AE310112	125	AG010111	127
AB030076-00	162	AE300064-06	122	AE310122	124	AG010118A	128
AB030076-01	162	AE300064-07	122	AE310146B	125	AG010138	160
AB030076-02	162	AE300064-15	122	AE310146D	125	AG010138-B	160
AB030076-03	162	AE300064-16	122	AE310146E	125	AG010140	160
AB030076-05	162	AE300100-040	122	AE310146G	125	AG010141	160
AB030076-06	162	AE300100-042	122	AE310146H	125	AG010142	160
AB030076-07	162	AE300100-060	122	AE310150	124	AG010143	160
AB030076-11	162	AE300103	122	AE310172	125	AG010147	128
AB030076-13	162	AE300149	194	AE310180	125	AG010150SC	28
AB030076-14	162	AE300152	122	AE310183	125	AG010154	192
AB030076-15	162	AE300154B	126	AE320023	125	AG010159	127
AB030076-17	162	AE300168	126	AE320034	125	AG010163A	127
AB030076-18	162	AE300168-1	126	AE320035	125	AG010164	127
AB030076-20	162	AE300173	123	AE320044	125	AG010167	162
AB030076-21	162	AE300176-A	123	AE330004	159	AG010168	162
AB030076-24	162	AE300179-02	140	AE330005	159	AG010169	162
AB030076-26	162	AE300179-03	140	AE330008	159	AG010184B	77
AB030076-27	162	AE300180	140	AE330009	159	AG010184C	77
		AE300201	126	AE330013	159	AG010184D	77

AG010184E	77	AI010139	147	AI030010	135	AI060030	140
AG010184F	77	AI010153	161	AI030011	135	AI060030-A	140
AG010185	159	AI010166	131	AI030020	135	AI060030-B	140
AG010204	149	AI010167	131	AI030025	135	AI060030-C	140
AG010205	144	AI010176	132	AI030027	135	AI060030-D	141
AG010207	114	AI010195	132	AI030045	112	AI060030-E	141
AG010208	128	AI010201	136	AI030067	138	AI060030-F	141
AG010219	192	AI020015	132	AI030075	143	AI060031	141
AG010222	192	AI020019	132	AI040005	135	AI060031-A	141
AG010224	114	AI020020	132	AI040006	136	AI060031-B	141
AG010225	128	AI020021	132	AI040007	135	AI060031-C	141
AG010227	128	AI020024	132	AI040008	135	AI060031-D	141
AG010229	128	AI020025	132	AI040011	136	AI060031-E	141
AG010236	192	AI020027	132	AI040017	136	AI060031-G	141
AG1	Pág.	AI020043	132	AI040018	136	AI060031-H	141
AG10001SP	28	AI020047	132	AI040031	135	AI060031-J	141
AG10001SP-D	129	AI020048A	132	AI040060	136	AI1	Pág.
AG10001SP-G	128	AI020048D	132	AI040245	161	AI10001SP	28
AG10001SP-T	129	AI020048E	132	AI040246	136	AI10002SP	28
AG10001SP-W	129	AI020049	132	AI050001	138	AI10003SP	29
AG10002SC	39	AI020051	132	AI050004	136	AL0	Pág.
AG10002SC-W	129	AI020052	133	AI050004A	137	AL010006	141
AH0	Pág.	AI020054	133	AI050009A	137	AL010011	141
AH020002	129	AI020056A	133	AI050022	138	AL010029	152
AIO	Pág.	AI020066	133	AI050024	138	AL010038	151
AI010006	129	AI020074	126	AI050037	138	AL010041	151
AI010009	129	AI020092	133	AI050040	138	AL010044	148
AI010017	129	AI020101A	133	AI050042	138	AL010053A	152
AI010023	129	AI020101A-A	133	AI050043	138	AL010057	150
AI010029	129	AI020103	133	AI050043S	135	AL010070	148
AI010030	129	AI020107	133	AI050071S	150	AL010071	148
AI010033	139	AI020109	134	AI050071S	148	AL010072	152
AI010037	130	AI020113	150	AI050076	138	AL010073	141
AI010041	130	AI020127	152	AI050077	138	AL010087	153
AI010060	131	AI020131	134	AI050079	152	AL010088	153
AI010060-A	131	AI020142	134	AI050080	138	AL010093	140
AI010060-B	131	AI020154	152	AI050085A	150	AL010099	147
AI010060-C	131	AI020158	162	AI050092	139	AL010113	161
AI010060-D	131	AI020162	134	AI050093	139	AL010114	161
AI010063A	131	AI020163	134	AI050096S	139	AL010116	161
AI010069	152	AI020164	161	AI050102	139	AL010117	161
AI010070	152	AI020178	134	AI050104	139	AL010128	147
AI010086	131	AI020180	134	AI050109	139	AL010175	150
AI010090A	131	AI020184	150	AI050113	139	AL010175	148
AI010092	131	AI020184	134	AI050135	161	AL010190	151
AI010097	149	AI020184A	152	AI050152	139	AL010196	148
AI010104	131	AI020184A	134	AI050152A	139	AL010202	153
AI010107	148	AI020184A	148	AI050172	161	AL010203	153
AI010108	153	AI020184B	150	AI050175	138	AL010205	149
AI010110	153	AI020184B	134	AI050176	139	AL010218	149
AI010114	149	AI020184S	134	AI050191	140	AL010225	153
AI010115	147	AI020185	134	AI050192	140	AL010282	149
AI010116	149	AI020186	150	AI050200	150	AL010291	153
AI010121	147	AI020201	135	AI050201	152	ANO	Pág.
AI010127	131	AI020205	135	AI050202	139	AN010001	141
AI010136	150	AI030002	136	AI060006	140	AN010001C	141
AI010137	131	AI030007	135	AI060020	140	AN010001D	142

AN010001D-2	142	AN020007-1	144	AS-0013A2	177	BOUTJW28A	191
AN010001D-3	142	AN020022	145	AS-0013C	177	BOUTJW29A	191
AN010001D-4	142	AN020022-A	145	AS-0015	177	C-1	Pág.
AN010001D-5	142	AN020022-B	145	AS-0015C	177	C-10DW42	22
AN010001D-6	142	AN020022-C	145	AS-0026	177	C-13DW53	22
AN010001D-7	142	AN020022-D	145	AS-0065	127	C-1DM1	20
AN010001D-A	142	AN040035A	145	AT	Pág.	C-3	Pág.
AN010001D-E	142	AN040043A	145	AT-6034-1A	181	C-3DH2	23
AN010001D-F	142	AN040055	162	AT-6952P-37	180	C-3DH262	23
AN010001D-K	142	AN040056	162	AZ	Pág.	C-3DH5	23
AN010001D-M	142	AN040062	161	AZ-0514-06	183	C-3DW5	20
AN010001D-N	142	AN040066	161	BL	Pág.	C-4	Pág.
AN010009A	138	AN040082	145	BLACK POWER 19	9	C-4DWA1	21
AN010030	138	AN040100	151	BO	Pág.	C-4DWA1G	21
AN010033	142	AN040101	145	BOUTJW01A-L	188	C-5	Pág.
AN010038	142	AN040105	161	BOUTJW01A-M	188	C-5CD	23
AN010045	124	AN040126	150	BOUTJW01A-XL	188	C-6	Pág.
AN010049	142	AN040168	145	BOUTJW02A	188	C-6DA4	23
AN010054A	143	AN040200	161	BOUTJW03B	188	C-6DA494	23
AN010054N	143	AN040286	149	BOUTJW04A-L	188	C-6DWB1	21
AN010063	142	AN040327	143	BOUTJW04A-M	188	C-6DWB5	21
AN010065	142	AN1	Pág.	BOUTJW04A-XL	188	C-7	Pág.
AN010066	143	AN100002SP	29	BOUTJW05A	188	C-7 TOWER	22
AN010068	143	ARO	Pág.	BOUTJW06B	188	C-7DC2B	21
AN010072	143	AR020016	194	BOUTJW07A-L	188	C-7DS1	21
AN010072C	143	AR020018	145	BOUTJW07A-M	188	C-7DW1-TS	24
AN010081A	142	AR020019	145	BOUTJW07A-XL	188	C-7DW9	21
AN010085A	142	AR020053A	145	BOUTJW07B-L	188	C-A	Pág.
AN010091A	143	AR020060	194	BOUTJW07B-M	188	C-A10	25
AN010092	143	AR020061	194	BOUTJW07B-XL	188	C-A11	25
AN010102	142	AR030013	145	BOUTJW08B-50	189	C-A12	25
AN010106A	143	AR030022	162	BOUTJW08B-52	189	C-A13	25
AN010106A-C	143	AR030034	145	BOUTJW08B-54	189	C-A16W	22
AN010112	143	AR030041	146	BOUTJW13A	189	C-A17W	22
AN010131	143	AR030047	146	BOUTJW14B	189	C-A17WG	22
AN010137	144	AR030058	93	BOUTJW15B	189	C-A2501S	25
AN010160	142	AR030062	146	BOUTJW16A	189	C-A27	24
AN010177B	147	AR030067	194	BOUTJW17A-1	189	C-A3	24
AN010186B	144	AR040016	146	BOUTJW17A-2	189	C-A3-B	24
AN010187	161	AR040043	146	BOUTJW18A	189	C-A31	24
AN010188A	144	AR060002A	146	BOUTJW19A	190	C-A3G	24
AN010188B	144	AR060003	146	BOUTJW20A-L	190	C-A456	24
AN010188C	144	AR060008	146	BOUTJW20A-M	190	C-A7	25
AN010202	153	AR060010	146	BOUTJW20A-XL	190	C-A8	25
AN010202B	153	AR060011	146	BOUTJW21A-L	190	C-A9	24
AN010225	144	AR060020	146	BOUTJW21A-M	190	C-APB	25
AN010226	144	AR060021	146	BOUTJW21A-XL	190	C-B	Pág.
AN010235	161	AR060024A	147	BOUTJW22A-L	190	C-B5	25
AN010237	161	AR060032	147	BOUTJW22A-M	190	C-BS Kit1	24
AN010272	144	AR060038	146	BOUTJW22A-XL	190	C-BS Kit2	24
AN010279	144	AR060039A	146	BOUTJW23A-L	190	C-BS Kit3	24
AN010293	142	AR060043	147	BOUTJW23A-M	190	C-D	Pág.
AN010319	144	AR060055	146	BOUTJW23A-XL	190	C-DBU1	194
AN010320	144	AR060056	146	BOUTJW24A	190	C-DBU7	194
AN010321	142	AR060062	143	BOUTJW25B	190	C-DM1	114
AN010322	142	AS	Pág.	BOUTJW26A	190	C-DMH212	75
AN020007	144	AS-0013	177	BOUTJW27A	191	C-DMH314	75

C-DMH414	75	D10	Pág.	D130H120	103	D175T50	104
C-DS14	191	D100MN08M	104	D130H40	103	D175T55	104
C-DSP	191	D100MN10M	104	D130H50	103	D37	Pág.
C-DSP-0WB10	191	D100MN12M	104	D130H60	103	D3750P0	100
C-P	Pág.	D100MN13M	104	D130H70	103	D3750P00	100
C-PC1	24	D100MN14M	104	D130H80	103	D3750P08S	100
C-PC2	24	D10M30M05A	104	D130T20	103	D3750P1	100
C-PC3	24	D10M30M06A	104	D130T25	103	D3750S10	100
C-PC4	24	D10M30M08A	104	D130T30	103	D3750S16	100
C-S	Pág.	D10M30M10A	104	D130T40	103	D3750S20	100
C-S7DW1	19	D10M30M12A	104	D130T45	103	D3750S24	100
C-SA2	18	D10M30M14A	104	D130T50	103	D3750S30	100
C-SA2S	18	D10M75M05A	104	D130T55	103	D3750T08S	100
C-SA3	18	D10M75M06A	104	D15	Pág.	D3750T10	100
C-SA3S	18	D10M75M08A	104	D150F5510A	103	D3750T15	100
C-SA4S	19	D10M75M08A	104	D150F6512A	103	D3750T18S	100
C-SG	20	D10M75M10A	104	D150F8012A	103	D3750T20	100
C-SInox	20	D10M75M12A	104	D150H030A	104	D3750T5	100
C-SM	20	D10M75M14A	104	D150H040B	104	D3750T6	100
C-SP3401	19	D12	Pág.	D150H050A	104	D3750T7	100
C-SQ2401	19	D125F4506A	103	D150H060B	104	D3750T8	100
C-SQ3401	19	D125F6512A	103	D150H070B	104	D3750T9	100
C-SQ3402	19	D125F8016A	103	D150H080B	104	D376514SC	39
C-SQ3403	19	D125H015A	103	D150MH1AD	104	D70	Pág.
C-SR3401	20	D125H020A	103	D150MH1QD	104	D70105KV	36
C-SU01	20	D125H025A	103	D150P1A	103	D70105SP	29
C-SU02	20	D125H030A	103	D150P2A	103	D70P175	96
C-SW01	20	D125H040A	103	D150P3A	103	D70P2100	96
C-SW02	20	D125H050A	103	D150T20A	104	D70P3125	96
C-T	Pág.	D125H060A	103	D150T25A	104	D70P3150	96
C-T12	23	D125H070A	103	D150T27A	104	D70PP07S	96
C-T3	22	D125P1F	103	D150T30A	104	D70PP10S	96
C-T4A	194	D125P2F	103	D150T40A	104	D70PS119KV	36
C-T5G-DP	194	D125P3F	103	D150Z1A	103	D70S475	96
C-W	Pág.	D125T06B	103	D150Z2A	103	D70S5100	96
C-WHEEL1	25	D125T08B	103	D150Z3A	103	D70S6125	96
C-WHEEL2	25	D125T10A	103	D16	Pág.	D70S6150	96
C-WHEEL5	25	D125T15A	103	D165MN06M	105	D70S8150	96
C-WHEEL6	25	D125T20A	103	D165MN07M	105	D70S8175	96
C-WHEEL8	25	D125T25A	103	D165MN08M	105	D70S9175	96
C-WHEEL9	25	D125T27A	103	D165MN10M	105	D70S9250	96
CF	Pág.	D125T30A	103	D165MN12M	105	D71	Pág.
CF-K-C	179	D125T40A	103	D165MN13M	105	D71157SV	34
CF-K-E	179	D125TT08B	104	D17	Pág.	D71400T10	98
CF-K-E	180	D125TT10B	104	D175H100	104	D71400T15	98
CF-K-F	179	D125TT15B	104	D175H120	104	D71400T20	98
CF-K-G	179	D125TT20B	104	D175H40	104	D71400T25	98
CF-K-I	179	D125TT25B	104	D175H50	104	D71400T27	98
CF-K-J	179	D125TT27B	104	D175H60	104	D71400T30	98
CH	Pág.	D125TT30B	104	D175H70	104	D715N05	99
CHAPEIRO20- BLACK	14	D125TT35B	104	D175H80	104	D715N07	99
CHAPEIRO20-C	14	D125TT40B	104	D175H80	104	D715N08	99
CHAPEIRO20-V	14	D125Z1A	103	D175T20	104	D715N10	99
CHAPEIROALU-BLACK	15	D125Z2A	103	D175T25	104	D715N12	99
CHAPEIROALU-C	15	D125Z3A	103	D175T30	104	D715N13	99
CHAPEIROALU-V	15	D13	Pág.	D175T40	104	D71C105S	99
		D130H100	103	D175T45	104		

D71C106S	99	D71Z060	98	ELECTR-C	13	H01SA115	105
D71P060	97	D71Z105S	99	ELECTR-V	13	H01SA120	105
D71P1100	97	D71Z107S	100	ELECTR. 1000 BLACK	11	H01SA125	105
D71P1150	97	D71Z138	98	ELECTR. 1000-C	11	H01SA130	105
D71P1300	97	D71Z180	98	ELECTR. 1000-V	11	H01SA140	105
D71P138	97	D71Z2100	98	EV	Pág.	H01SA150	105
D71P180	97	D71Z3150	98	EVA POWER BLACK	7	H01SA160	105
D71P2100	97	D71Z4200	98	EVA POWER-C	7	H01SA180	105
D71P2150	97	D72	Pág.	EVA POWER-V	7	H01SM109S	105
D71P2250	97	D725N06	98	F	Pág.	H02	Pág.
D71P238	97	D725N07	98	FITA JW	191	H02MH217S	105
D71P2400	97	D725N08	98	GM	Pág.	H02SM109S	106
D71P3150	97	D725N08SP	29	GM-02AF	184	H02SM209S	106
D71P3250	97	D725N09	98	GM-02AH	184	H03	Pág.
D71P3400	97	D725N10	98	GM-02AM	184	H03MH118S	106
D71P4200	97	D725N11	98	GM-02BH	184	H03SM109S	106
D71PP08KV	36	D725N12	98	GM-02BPH	185	H03SS109S	106
D71PP08S	99	D725N13	98	GM-02PF	185	H05	Pág.
D71PP08SP	29	D73	Pág.	GM-02PH	185	H05SA109S	106
D71PP16S	99	D737128SV	34	GM-02PM	185	H05SS109S	106
D71S10250	97	D737134SV	34	GM-03AF	184	H06	Pág.
D71S250	97	DBT	Pág.	GM-03AH	184	H06MT109S	106
D71S360	97	DBT31B	101	GM-03AM	184	H06SA109S	106
D71S4100	97	DBT53A	101	GM-03PF	185	H06SA1100	106
D71S4150	97	DR0	Pág.	GM-03PH	185	H06SA115	106
D71S4200	97	DR0107S	101	GM-03PM	185	H06SA120	106
D71S480	97	DR0253S	101	GM-04AF	184	H06SA125	106
D71S5125	97	DR04	101	GM-04AH	184	H06SA130	106
D71S5200	97	DS9	Pág.	GM-04AM	184	H06SA140	106
D71S5300	97	DS96	191	GM-04PF	185	H06SA150	106
D71S538	97	DV1	Pág.	GM-04PH	185	H06SA160	106
D71S575	97	DV13P060	115	GM-04PM	185	H06SA180	106
D71S6100	97	DV13P180	115	H01	Pág.	H06SM209S	106
D71S6150	97	DV13P2100	115	H01B1015	105	H06SM2100	106
D71S638	97	DV13P3150	115	H01B1020	105	H06SM225	106
D71S6400	97	DV13PP07S	115	H01B1025	105	H06SM230	106
D71S8150	97	DV13S275	115	H01B1030	105	H06SM240	106
D71S8200	97	DV13S4100	115	H01B1035	105	H06SM250	106
D71S8300	97	DV13S5125	115	H01B1040	105	H06SM255	106
D71S8500	97	DV13S6150	115	H01B1045	105	H06SM260	106
D71S9175	97	DV13Z060	115	H01B1050	105	H06SM280	106
D71T10	98	DV13Z180	115	H01B1055	105	H06SN170	106
D71T107S	99	DV13Z2100	115	H01B1060	105	H06W106S	107
D71T109S	99	DV13Z3150	115	H01B1070	105	H07	Pág.
D71T15	98	DV14PP-TP	96	H01B1080	105	H07M09S	107
D71T20	98	DV15109S	116	H01B1090	105	H07MT10	107
D71T25	98	DV4	Pág.	H01B1100	105	H07MT15	107
D71T27	98	DV4118SV	115	H01B1120	105	H07MT20	107
D71T30	98	DV41M06S	116	H01B1140	105	H07MT25	107
D71T40	98	DV41M10	115	H01B1160	105	H07MT27	107
D71T45	98	DV41M13	115	H01B1170	105	H07MT30	107
D71T5	98	DV41M5	115	H01B1180	105	H07MT40	107
D71T50	98	DV41M6	115	H01B1190	105	H07MT45	107
D71T6	98	DV41M7	115	H01B1220	105	H07MT50	107
D71T7	98	DV41M8	115	H01MH118S	105	H08	Pág.
D71T8	98	EL	Pág.	H01SA109S	105	H0816S	107
D71T9	98	ELECTR-BLACK	13	H01SA1100	105	H08MTP09S	107

H08S110S	107	H20MT25	108	JA-7253	183	JAG-6639-DC	173
H08ST09085	107	H20MT27	108	JA-7254	183	JAG-6639-DR	173
H08ST10090	107	H20MT30	108	JA-950	177	JAG-6639-RK	173
H08ST15100	107	H20MT40	108	JA-950-04	177	JAH	Pág.
H08ST20115	107	H20MT45	108	JA-960	177	JAH-0288	181
H08ST25130	107	H20MT50	108	JA-C131SV	34	JAH-0288-15	181
H08ST27145	107	H22	Pág.	JA-HVLP-1080GD-N1.4	176	JAH-0288-16	181
H08ST30165	107	H22S109S	109	JA-HVLP-1080GK	176	JAH-0288-17	181
H08ST40185	107	HC	Pág.	JA-HVLP-3000-NS17	176	JAH-0288-RK	181
H08ST45205	107	HC-100/15	137	JA-HVLP-3000-NS19	176	JAH-308HK	181
H08ST50230	107	HC-106/15	137	JA-HVLP-300C (1.3)	176	JAH-308HK-RK	181
H10	Pág.	HC-108/15	137	JA-HVLP-6112	176	JAH-6837	181
H10121SV	34	HC-108/18	137	JA-LVLP-0303W	176	JAH-6837-50	181
H10MB08KV	37	HC-65/14	137	JA-LVLP-0303W-N	176	JAH-6837-50-2	181
H10MB08S	107	HC-65/67	137	JA-LVLP-0303W-N18	176	JAH-6837-RK	181
H10MB08SP	29	HC-65103	137	JAB	Pág.	JAH-7104H	181
H10MB10200	107	HC-66/6	137	JAB-1017	170	JAH-7104H-RK	181
H10MB2100	107	HC-68/14	137	JAB-1017-RK	170	JAI	Pág.
H10MB25100	107	HC-73/14	137	JAB-1018	170	JAI-0501-RK	168
H10MB3100	107	HC-74/15	137	JAB-1018-RK	170	JAI-0926-RK	166
H10MB4100	107	HC-74/76	137	JAB-7003A	171	JAI-0936	166
H10MB5150	107	HC-75/77	137	JAB-7003A-RK	171	JAI-0936-RK	166
H10MB6150	107	HC-76/12	137	JAD	Pág.	JAI-0938	167
H10MB8200	107	HC-76/14	137	JAD-0212	169	JAI-0938-RK	167
H10MT08KV	37	HC-76/30	137	JAD-0212-RK	169	JAI-0954	165
H10MT08SP	29	HC-76/8	137	JAD-0413	169	JAI-0954-RK	165
H10MT09S	107	HC-78/15	137	JAD-0413-RK	169	JAI-1024	164
H10MT10100	108	HC-80/15	137	JAD-0534	169	JAI-1024-RK	164
H10MT15100	108	HC-80/82	137	JAD-1015-RK	171	JAI-1054	165
H10MT20100	108	HC-86/16	137	JAD-1015K	171	JAI-1054-RK	165
H10MT25100	108	HC-86/18	137	JAD-1020	170	JAI-1114	164
H10MT27150	108	HC-9.5mm	137	JAD-1020-RK	170	JAI-1114-RK	164
H10MT30150	108	HC-90/15	137	JAD-1021	170	JAI-1114K	164
H10MT40150	108	HC-92/10	137	JAD-1021-RK	170	JAI-1124	164
H10MT45200	108	HC-93/15	137	JAD-1027	170	JAI-1124-RK	164
H10MT50200	108	HC-93/36	137	JAD-1027-RK	170	JAI-1138	167
H12	Pág.	HC-93/45	137	JAD-6252A	170	JAI-1138-RK	167
H12S09085	108	HC-95/15	137	JAD-6252A-RK	170	JAI-1138L	167
H12S10090	108	HC-96/18	137	JAG	Pág.	JAI-1206L	166
H12S110S	108	HV	Pág.	JAG-0903-MS	171	JAI-1206L-RK	167
H12S15100	108	HV1000V-BLACK	12	JAG-0906R/RM-RK	171	JAI-1232-RK	165
H12S20115	108	HV1000V-C	12	JAG-0906RMK	171	JAI-1232K	165
H12S25130	108	HV1000V-V	12	JAG-0913RM-RK	171	JAI-1408	167
H12S27145	108	JA	Pág.	JAG-0913RMK	171	JAI-1408-RK	167
H12S30165	108	JA-0001RK	177	JAG-0923RM	172	JAI-1408L	167
H12S40185	108	JA-300C-28	177	JAG-0923RM-RK	172	JAI-1513	165
H12S45205	108	JA-300C-NS13	176	JAG-0925RM	172	JAI-1513-RK	165
H12S50230	108	JA-3806C	177	JAG-0925RM-RK	172	JAI-1514	166
H15	Pág.	JA-3808A	177	JAG-0955RM	172	JAI-1514-RK	166
H15M105S	108	JA-3812A	182	JAG-0955RM-RK	172	JAI-1524	164
H20	Pág.	JA-3812D	182	JAG-1087	172	JAI-1524-RK	165
H20MB1037S	109	JA-5032	182	JAG-1087-RK	172	JAI-6202-RK	168
H20MT08SP	29	JA-6111-NS13	176	JAG-6638	172	JAI-6211	166
H20MT09S	109	JA-6111-NS17	176	JAG-6638-DC	172	JAI-6211-RK	166
H20MT10	108	JA-6111-NS20	176	JAG-6638-DR	172	JAI-6212-RK1	166
H20MT15	108	JA-6111(1.4)	176	JAG-6638-RK	172	JAI-6212K	166
H20MT20	108	JA-6111K	176	JAG-6639	172		

JAR	Pág.	JAS-6552-RK	173	JAT-69055	183	M04	Pág.
JAR-1012	168	JAT	Pág.	JAT-6943A	180	M04008	110
JAR-1012-RK	168	JAT-1011	178	JAT-6943A-RK	180	M04012	110
JAR-1013	168	JAT-1011-RK	178	JAT-6952	180	M04016	110
JAR-1013-RK	168	JAT-1020-RK	178	JAT-6952-RK	180	M04024	110
JAR-1033	169	JAT-1020K	178	JAT-6952P	180	M04032	110
JAR-1033-RK	169	JAT-1035	182	JAT-6952P-39	180	M05	Pág.
JAR-1094	168	JAT-1035-RK	182	JAT-6952P-40	180	M05020	110
JAR-1094-RK	168	JAT-1041	178	JAT-6952P-RK	180	M06	Pág.
JAR-6309A-RK	168	JAT-1041-16S	178	JAT-6959	183	M06030	110
JAR-6309AK	168	JAT-10T18	179	JAT-6959A	183	M06040	110
JAR-6310A	168	JAT-10T32	179	JAZ	Pág.	M07	Pág.
JAR-6310A-RK	169	JAT-12F1	178	JAZ-0001B	183	M07016	110
JAR-6310AK	169	JAT-12F2	178	JAZ-0002A	183	M07016-ACE	110
JAS	Pág.	JAT-12F3	178	JAZ-0002B	183	M07016-TPR	110
JAS-0010	173	JAT-12F4	178	JAZ-0002C	183	M09	Pág.
JAS-0010-41	173	JAT-20T14	178	JAZ-0042	183	M09100	110
JAS-0010-RK	173	JAT-20T18	178	JAZ-011H	181	M091000	110
JAS-0413	173	JAT-20T24	178	JAZ-016H	181	M09103KV	37
JAS-0413-RK	173	JAT-460	182	JAZ-0512	184	M09200	110
JAS-0423-31	174	JAT-480-NS	182	JAZ-0513	184	M09300	110
JAS-0423-RK	174	JAT-481	182	JAZ-0513-09	183	M09500	110
JAS-0423K	174	JAT-501	182	JAZ-0513-50	183	M09513SP	30
JAS-0452	177	JAT-6004K	182	JAZ-0514	184	M09800	110
JAS-0452-RK	178	JAT-6034	181	JAZ-0514-06	183	M10	Pág.
JAS-1021-6HE-RK	174	JAT-6034-1B	181	JAZ-0514-09	183	M10110	158
JAS-1021-6HE(2.5)	174	JAT-6034-1C	181	JAZ-0514-13	183	M10210A	158
JAS-1031-6HE	175	JAT-6034-1D	181	JAZ-0514-13	183	M10210B	158
JAS-1031-6HE-RK	175	JAT-6034-RK	181	JAZ-0514-48	183	M10410A	158
JAS-1031-6HP	175	JAT-6412	180	JAZ-0516	184	M10410B	158
JAS-1031-6HP	175	JAT-6412-RK	180	JAZ-3811E	182	M11	Pág.
JAS-1206-6HE	174	JAT-6421	179	JAZ-39520	183	M11035	110
JAS-1206-6HE-RK	174	JAT-6421-33	179	JAZ-6704-O	184	M11045	110
JAS-1206-6HP	174	JAT-6421-RK	179	JAZ-6704-W	184	M11065	110
JAS-1206-6HP	175	JAT-6441-RK	179	JAZ-6704A	184	M29	Pág.
JAS-1207-6HE	174	JAT-6441K	179	JAZ-6704A	184	M2927	110
JAS-1207-6HE-56	174	JAT-6443-K1	180	JAZ-6710A	184	M2927-T1	110
JAS-1207-6HE-57	175	JAT-6443-K2	180	JAZ-6711A	184	M2927-T2	110
JAS-1207-6HE-RK	174	JAT-6443-K3	180	JAZ-6712A	184	M2932	110
JAS-6505	173	JAT-6443-K4	180	JAZ-6715A	184	M2932-T1	110
JAS-6505-RK	173	JAT-6443-K5	180	JAZ-7207	171	M2932-T2	110
JAS-6531	175	JAT-6443-K6	180	JAZ-7214F	184	M2940-T1	110
JAS-6531-LIXA	175	JAT-6443-K7	180	JAZ-7214S	184	M2940-T2	110
JAS-6531-RK	175	JAT-6443-RK	180	JAZ-7214Z	184	M2950-T1	110
JAS-6535-5HE	175	JAT-6443K	180	JAZ-ST4	191	M2950-T2	110
JAS-6535-5HE-47	175	JAT-6613	179	JW	Pág.	M60	Pág.
JAS-6535-5HE-RK	175	JAT-6613-P	179	JW-01B	188	M60103	111
JAS-6535-5VE-RK	175	JAT-6613-PA	179	JW-BACKPACK	189	M60104	111
JAS-6535-6HE	175	JAT-6613-RK	179	JW-OPENER	191	M60105	111
JAS-6535-6HE-RK	175	JAT-6673	182	JW-USB	189	M61	Pág.
JAS-6542	178	JAT-6673-RK	182	K	Pág.	M61110	111
JAS-6542-RK	178	JAT-6676	179	KIT AR	185	M61112	111
JAS-6543	178	JAT-6676-RK	179	M01	Pág.	M61113	111
JAS-6543-RK	178	JAT-6904S	183	M01016	110	M61116	111
JAS-6551	173	JAT-6905-C	183	M01020	110	M61119	111
JAS-6551-RK	173	JAT-6905-J	183	M03	Pág.	M61122	111
JAS-6552	173	JAT-6905B	183	M03025	110	M61125	111

M61H116	112	MF05B	112	MSH3814	75	P-EVA(W26134SV)	42
M61H119	112	MF05C	112	MT0	Pág.	P-EVA(W2623431SV)	42
M61H124	112	MF05D	112	MT010001	156	P-T	Pág.
M62	Pág.	MF05E	112	MT010002	156	P-TR (D70SP06ST)	43
M62102	111	MF05S	112	MT010003	156	P-TR (PC303ST)	43
M62103	111	MFM	Pág.	MT010004	156	P-TR (S04H4120ST)	43
M62104	111	MFM06S	112	MT010005	156	P-TR (S04H4506ST)	43
M62105	111	MG0	Pág.	MT010006	156	P-TR (W26107ST)	43
M62106	111	MG010001	154	MT010007	156	P-TR (W26920ST)	43
M62108	111	MG010002	154	MT010008	156	P-TR (AG010002SP)	43
M62H102	112	MG010003	154	MT0201	113	P-TR (AG010026SP)	43
M62H103	112	MG010004	154	MT0703	113	P-TR (A110002SP)	43
M62H104	112	MG010005	154	MTC	Pág.	P-TR (D70105SP)	43
M62H106	112	MG010006	154	MTC101SP	30	P-TR (D71PP08SP)	43
M63	Pág.	MG010008	154	MTC1150	113	P-TR (H10MB08SP)	43
M63102	111	MG010009	154	MTC1200	113	P-TR (M09513SP)	43
M63103	111	MG020001	155	MTC1300	113	P-TR (M645114SP)	43
M63104	111	MG020003	155	MTC150	113	P-TR (P018SP)	43
M63105	111	MG020004	155	MTC153	113	P-TR (P04704SP)	43
M63106	111	MG020006	155	MTC156	113	P-TR (P0803SP)	43
M63106S	112	MG020007	155	MTC200	113	P-TR (P0903SP)	43
M63108	111	MG020008	155	MTC306	114	P-TR (P2710SP)	43
M63113KV	37	MHS	Pág.	MTC308	114	P-TR (S03A4122SP)	43
M63H103	112	MHS08KV	37	MTC408	114	P-TR (S04H2125SP)	43
M63H105	112	MHS100AG	113	MTC508	114	P-TR (S04H3157SP)	43
M63H106	112	MHS300	113	MTM	Pág.	P-TR (S04H3536SP)	43
M63H108	112	MI1	Pág.	MTM1025	114	P-TR (S04H4125SP)	43
M63M106S	112	MI010014	155	MTM1050	114	P-TR (S04H4524SP)	43
M64	Pág.	MI010016	155	MTM1075	114	P-TR (S04H4726SP)	43
M64105	111	MI010017	155	MTM1100	114	P-TR (S04H4728SP)	43
M64105S	112	MI010018	155	P-B	Pág.	P-TR (S06H427SP)	43
M645114SP	30	MI010019	155	P-B (31)	43	P-TR (S09H4118SP)	43
M64M105S	112	MI010020	155	P-B (41)	43	P-TR (S29H4140SP)	43
ME0	Pág.	MI010021	155	P-E	Pág.	P-TR (W23108SP)	43
ME010001	154	MI020001	155	P-EVA(D70105KV)	41	P-TR (W25110SP)	43
ME010007	154	MI020002	155	P-EVA(D71PP08KV)	41	P-TR (W26112SP)	43
ME010009	154	MI020004	155	P-EVA(D737128SV)	41	P-TR (W26116SP)	43
ME010010	154	MK2	Pág.	P-EVA(D737134SV)	41	P01	Pág.
ME010012	154	MK2040	113	P-EVA(H10121SV)	41	P0118	90
ME020001	154	MK2040-B	113	P-EVA(H10MB08KV)	41	P011804KV	37
ME020002	154	MK2080	113	P-EVA(H10MT08KV)	41	P018	88
ME020003	154	MKS	Pág.	P-EVA(M09103KV)	41	P018SP	30
ME020005	154	MKS27	113	P-EVA(M63113KV)	41	P018SP1	30
ME020006	154	MKS27-12	113	P-EVA(MHS08KV)	41	P03	Pág.
MEC	Pág.	MKS27-16	113	P-EVA(P32M105KV)	41	P038	88
MEC PESADOS 20A	17	MKS27-16A	113	P-EVA(P82714SV)	41	P04	Pág.
MEC PESADOS 20B	17	MKS27-20	113	P-EVA(P82736SV)	41	P046	88
MEC POWER 19C	9	MKV	Pág.	P-EVA(S03A4122KV)	42	P04704SP	30
MEC POWER 19V	9	MKV7	116	P-EVA(S04H2132KV)	42	P05	Pág.
MEC PROF20-BLACK	10	MKV7-K	116	P-EVA(S04H4144KV)	42	P0516	90
MEC PROF20-C	10	MKV8	116	P-EVA(S04H42165SV)	42	P0518	90
MEC PROF20-V	10	MNO	Pág.	P-EVA(S04H4295SV)	42	P06	Pág.
MEC SOLUTION BLACK	8	MNO20004	155	P-EVA(S04H45121SV)	42	P068	88
MEC SOLUTION-C	8	MNO20005	156	P-EVA(S29H4141KV)	42	P068A	88
MEC SOLUTION-V	8	MSH	Pág.	P-EVA(W23559SV)	42	P07	Pág.
MFO	Pág.	MSH1214	75	P-EVA(W25110KV)	42	P079	88
MF05A	112	MSH1414	75	P-EVA(W26116KV)	42		

P08	Pág.	P32	Pág.	P7603	92	PV2	Pág.
P0803SP	30	P32M03S	95	P7608	92	PV28110	117
P08104S	91	P32M05C	94	P77	Pág.	PV4	Pág.
P0813SC	39	P32M07A	93	P7719	92	PV4006	117
P0816	90	P32M105KV	37	P78	Pág.	R12	Pág.
P0817	90	P32M10A	93	P7801	95	R1206N	45
P0818	90	P32M10C	94	P7802	95	R1206N-R	47
P09	Pág.	P36	Pág.	P7803	95	R1206R	47
P0903SP	30	P36M01P	93	P7804	95	R12081	45
P0916	90	P36M02P	93	P7805	95	R12081RK	47
P0917	90	P36M06C	95	P78M10C	95	R19	Pág.
P0918	90	P36M09A	93	P80	Pág.	R19H310S	78
P10	Pág.	P36M09C	95	P8006	89	R19H3110	78
P1016	90	P37	Pág.	P81	Pág.	R19H3111	78
P1017	90	P37M11A	94	P8106	89	R19H3112	78
P1019	94	P37M18A	94	P82	Pág.	R19H3113	78
P11	Pág.	P38	Pág.	P82714SV	34	R19H3114	78
P1116	90	P38M09A	94	P82736SV	34	R19H3115	78
P1118	90	P38M11A	94	P86	Pág.	R19H3116	78
P12	Pág.	P40	Pág.	P8606	89	R19H3117	78
P1216	90	P4016	90	P90	Pág.	R19H3118	78
P1218	90	P43	Pág.	P9006	89	R19H3119	78
P14	Pág.	P4318	91	P94	Pág.	R29	Pág.
P1416	90	P4318-RK	92	P9409	94	R2902	46
P15	Pág.	P4330	91	P95	Pág.	R2902RK	47
P1516	90	P4330-RK	92	P9506	88	R2903RK	47
P15808	91	P52	Pág.	P9508C	89	R2904	46
P17	Pág.	P52A10	94	P9508D	89	R2904RK	47
P178	91	P52B10	94	P96	Pág.	R34	Pág.
P18	Pág.	P52C10	94	P9601	113	R3402RK	47
P1810	91	P52D12	94	P99	Pág.	R3403	46
P20	Pág.	P52M10	94	P9902S	89	R3403RK	47
P2010LA	91	P52N10	94	PES	Pág.	R3404RK	47
P2010RA	91	P53	Pág.	PESD05	91	R35	Pág.
P2010SA	91	P53M06	94	PESD10	91	R3502	46
P22	Pág.	P53M11	94	PESD11	91	R3503	46
P2205E	91	P53M18	94	PIN	Pág.	R3504	46
P2208A	91	P54	Pág.	PINTOR20-BLACK	16	R36	Pág.
P2212A	91	P54M08A	94	PINTOR20-C	16	R3602	46
P26	Pág.	P54M10A	94	PINTOR20-V	16	R3602RK	47
P266	88	P60	Pág.	PSV	Pág.	R3603	46
P27	Pág.	P6008	88	PSV110SC	117	R3603RK	47
P2706	88	P61	Pág.	PSV218SP	117	R3604RK	47
P2710	88	P6106	88	PV0	Pág.	R37	Pág.
P2710SP	30	P6108	88	PV0118	116	R3702	46
P2712	88	P6116	90	PV0518	116	R3702B	46
P28	Pág.	P64	Pág.	PV0816	116	R3703	46
P2803SP	31	P6424	92	PV0817	116	R3704	46
P2810	88	P71	Pág.	PV0918	116	R3704B	46
P28110	90	P7101	89	PV1	Pág.	R41	Pág.
P28110	90	P7102	89	PV1016	116	R4103	46
P28112	90	P7103	89	PV1116	116	R4104	46
P28210	91	P7104	89	PV1118	116	R45	Pág.
P28212	91	P7105	89	PV1218	116	R4502	46
P30	Pág.	P76	Pág.	PV1416	116	R4502JRK	47
P30M07C	94	P7601	92	PV1516	116	R4502RK	47
P30M10A	93	P7602	92				

R48	Pág.	S03A	Pág.	S03A6145	81	S03A8E04	83
R4802	46	S03A2110	79	S03A6146	81	S03A8E07	83
R4802A	46	S03A2112	79	S03A6147	81	S03A8E10	83
R4802B	46	S03A2114	79	S03A6148	81	S03AD	Pág.
R4802RK	47	S03A2UT	79	S03A6149	81	S03AD4110	80
R4803	46	S03A3UT	79	S03A6150	81	S03AD4111	80
R4804	46	S03A4109	80	S03A6151	81	S03AD4111S	79
R4804A	46	S03A4110	80	S03A6152	81	S03AD4112	80
R4804B	46	S03A4111	80	S03A6153	81	S03AD4113	80
R4804RK	47	S03A4111S	78	S03A6154	81	S03AD4114	80
R4811SC	39	S03A4112	80	S03A6155	81	S03AD4115	80
R51	Pág.	S03A4113	80	S03A6156	81	S03AD4116	80
R5103	47	S03A4114	80	S03A6157	81	S03AD4117	80
R5103RK	47	S03A4115	80	S03A6158	81	S03AD4118	80
R5104	47	S03A4116	80	S03A6159	81	S03AD4119	80
R5104RK	47	S03A4117	80	S03A6160	81	S03AD4120	80
R53	Pág.	S03A4118	80	S03A6163	81	S03AD4121	80
R53A-2A	78	S03A4119	80	S03A6165	81	S03AD4122	80
R53A-3A	78	S03A4120	80	S03A6167	81	S03AD4123	80
R53A-4A	78	S03A4121	80	S03A6170	81	S03AD4124	80
R58	Pág.	S03A4122	80	S03A6A4	82	S03AD4125	80
R5802ERK	47	S03A4122KV	37	S03A6A8	82	S03AD4126	80
R5803RK	47	S03A4122SP	31	S03A6E04	82	S03AD4127	80
R5804ERK	47	S03A4123	80	S03A6E08	82	S03AD4128	80
R5804LRK	47	S03A4124	80	S03A6E10	82	S03AD4130	80
R66	Pág.	S03A4127	80	S03A6U6	82	S03AD4132	80
R6602	47	S03A4129	80	S03A8109S	83	S03AD4303S	86
R6603	47	S03A4130	80	S03A8124	83	S03AD4307S	86
R6604	47	S03A4132	80	S03A8127	83	S03AD4317	86
R68	Pág.	S03A4211S	79	S03A8129	83	S03AD4319	86
R6802	47	S03A4A3	79	S03A8130	83	S03AD4321	86
R6802RK	47	S03A4A6	79	S03A8132	83	S03AD4414S	79
R6803	47	S03A4E4	79	S03A8133	83	S03AD4503S	86
R6803RK	47	S03A4E5	79	S03A8134	83	S03AD4517	87
R6804	47	S03A4E6	79	S03A8135	83	S03AD4519	87
R6804RK	47	S03A4E8	79	S03A8136	83	S03AD4521	87
RD0	Pág.	S03A4U4	79	S03A8138	83	S03AD6107S	82
RD01	47	S03A4UT	79	S03A8140	83	S03AD6120S	82
RD01032S	101	S03A4UT3S	79	S03A8141	83	S03AD6124	82
RD01032S	101	S03A6108S	81	S03A8144	83	S03AD6126	82
RD02	47	S03A6126	81	S03A8146	83	S03AD6127	82
RD05H2	102	S03A6127	81	S03A8150	83	S03AD6129	82
RV0	Pág.	S03A6129	81	S03A8155	83	S03AD6130	82
RV032	119	S03A6130	81	S03A8160	83	S03AD6132	82
RV033	119	S03A6132	81	S03A8165	83	S03AD6133	82
RV034	119	S03A6133	81	S03A8170	83	S03AD6134	82
S01U	Pág.	S03A6134	81	S03A8173	83	S03AD6135	82
S01U4108S	79	S03A6135	81	S03A8175	83	S03AD6136	82
S01U4113	79	S03A6136	81	S03A8176	83	S03AD6138	82
S01U4114	79	S03A6137	81	S03A8178	83	S03AD6140	82
S01U4115	79	S03A6138	81	S03A8180	83	S03AD6141	82
S01U4116	79	S03A6139	81	S03A8185	83	S03AD6142	82
S01U4117	79	S03A6140	81	S03A8189	83	S03AD6144	82
S01U4119	79	S03A6141	81	S03A8190	83	S03AD6146	82
S01U4121	79	S03A6142	81	S03A8192	83	S03AD6150	82
S01U4122	79	S03A6143	81	S03A8195	83	S03AD8107S	83
		S03A6144	81	S03A8A6	83	S03AD8117	84

S03AD8124	84	S03V4127	117	S04H4119	64	S04H6327	66
S03AD8126	84	S03V4132	117	S04H4120	64	S04H6329	66
S03AD8127	84	S04H	Pág.	S04H4121	64	S04H6330	66
S03AD8129	84	S04H2104	63	S04H4122	64	S04H6332	66
S03AD8130	84	S04H2104S	63	S04H4123	64	S04H6334	66
S03AD8132	84	S04H2105	63	S04H4124	64	S04H6336	66
S03AD8133	84	S04H2105S	63	S04H4125	64	S04H6338	66
S03AD8134	84	S04H2106	63	S04H4125S	59	S04H6341	66
S03AD8135	84	S04H2107	63	S04H4125SP	31	S04H6346	66
S03AD8136	84	S04H2108	63	S04H4126	64	S04H6350	66
S03AD8138	84	S04H2109	63	S04H4127	64	S04H6355	66
S03AD8140	84	S04H2110	63	S04H4128	64	S04H6356	66
S03AD8141	84	S04H2111	63	S04H4129	64	S04H6360	66
S03AD8142	84	S04H2112	63	S04H4130	64	S04H6365	66
S03AD8146	84	S04H2113	63	S04H4131SP	32	S04H6419	66
S03AD8148	84	S04H2114	63	S04H4132	64	S04H6421	66
S03AD8150	84	S04H2118S	58	S04H4134	64	S04H6422	66
S03AD8155	84	S04H2125SP	31	S04H4136	64	S04H6424	66
S03AD8158	84	S04H2132KV	38	S04H4144KV	38	S04H6426	66
S03AD8160	84	S04H2141S	58	S04H42165SV	35	S04H6427	66
S03AD8165	84	S04H2184SV	35	S04H4295SV	35	S04H6429	66
S03H	Pág.	S04H3106	63	S04H4524S	59	S04H6430	66
S03H2327S	58	S04H3107	63	S04H4524SP	32	S04H6432	66
S03S	Pág.	S04H3108	63	S04H46121SV	35	S04H6433	66
S03S8117	84	S04H3109	63	S04H4726SP	32	S04H6435	66
S03S8119	84	S04H3110	63	S04H4728S	59	S04H6436	66
S03S8121	84	S04H3111	63	S04H4728SP	32	S04H6438	66
S03S	Pág.	S04H3112	63	S04H5129SC	40	S04H6440	66
S03SD8117	84	S04H3113	63	S04H524127S	62	S04H6441	66
S03SD8119	84	S04H3114	63	S04H52460S	61	S04H6443	66
S03SD8121	84	S04H3115	63	S04H52477S	61	S04H6444	66
S03V	Pág.	S04H3116	63	S04H52478S	61	S04H6446	66
S03V2106	117	S04H3117	63	S04H6115S	59	S04H6447	66
S03V2108	117	S04H3118	63	S04H6119	65	S04H6450	66
S03V2110	117	S04H3119	63	S04H6121	65	S04H6456	66
S03V2114	117	S04H3120	63	S04H6122	65	S04H8115S	59
S03V3108	117	S04H3121	63	S04H6124	65	S04H8355	67
S03V3110	117	S04H3122	63	S04H6127	65	S04H8360	67
S03V3112	117	S04H3124	63	S04H6128	65	S04H8365	67
S03V3113	117	S04H3125S	58	S04H6130	65	S04HD	Pág.
S03V3114	117	S04H3141S	58	S04H6132	65	S04HD2105	63
S03V3116SC	117	S04H3157S	58	S04H6134	65	S04HD2106	63
S03V3117	117	S04H3157SP	31	S04H6136	65	S04HD2107	63
S03V3119	117	S04H3194SV	35	S04H6138	65	S04HD2108	63
S03V3122	117	S04H3536S	59	S04H6141	65	S04HD2109	63
S03V3136SV	118	S04H3536SP	31	S04H6146	65	S04HD2110	63
S03V4110	117	S04H4108	64	S04H6150	65	S04HD2111	63
S03V4111	117	S04H4109	64	S04H6152	65	S04HD2112	63
S03V4112	117	S04H4110	64	S04H624101S	62	S04HD2113	63
S03V4113	117	S04H4111	64	S04H6319	66	S04HD3109	64
S03V4114	117	S04H4112	64	S04H6321	66	S04HD3110	64
S03V4117	117	S04H4113	64	S04H6321S	59	S04HD3111	64
S03V4119	117	S04H4114	64	S04H6322	66	S04HD3112	64
S03V4120SC	118	S04H4115	64	S04H6323	66	S04HD3113	64
S03V4122	117	S04H4116	64	S04H6324	66	S04HD3114	64
S03V4124	117	S04H4117	64	S04H6325	66	S04HD3115	64
S03V4124SV	118	S04H4118	64	S04H6326	66	S04HD3116	64

S04HD3117	64	S05HD4118	67	S07H	Pág.	S09H206	71
S04HD3119	64	S05HD4119	67	S07H206	70	S09H207	71
S04HD3120	64	S05HD4120	67	S07H207	70	S09H303	71
S04HD3121	64	S05HD4121	67	S07H208	70	S09H304	71
S04HD3124	64	S05HD4122	67	S07H209	70	S09H305	71
S04HD4109	65	S05HD4123	67	S07H210	70	S09H306	71
S04HD4110	65	S05HD4124	67	S07H2138KV	38	S09H307	71
S04HD4111	65	S05HD4127	67	S07H215	70	S09H308	71
S04HD4112	65	S05HD4130	67	S07H220	70	S09H310	71
S04HD4113	65	S05HD4132	67	S07H225	70	S09H312	71
S04HD4114	65	S05HD4213S	67	S07H227	70	S09H314	71
S04HD4115	65	S06A	Pág.	S07H230	70	S09H404	72
S04HD4116	65	S06A408S	85	S07H240	70	S09H405	72
S04HD4117	65	S06A4T20	85	S07H310	70	S09H406	72
S04HD4118	65	S06A4T27	85	S07H315	70	S09H407	72
S04HD4119	65	S06A4T30	85	S07H320	70	S09H408	72
S04HD4115	65	S06A4T40	85	S07H325	70	S09H410	72
S04HD4120	65	S06A4T45	85	S07H327	70	S09H4109S	60
S04HD4121	65	S06A4T50	85	S07H330	70	S09H4118SP	32
S04HD4122	65	S06A4T55	85	S07H340	70	S09H412	72
S04HD4123	65	S06A4T60	85	S07H345	70	S09H414	72
S04HD4124	65	S06A4T70	85	S07H350	70	S09H416	72
S04HD4125	65	S06A4T80	85	S07H355	70	S09H417	72
S04HD4126	65	S06H	Pág.	S07H360	70	S09H419	72
S04HD4127	65	S06H204	69	S07H4109S	60	S09H4304	72
S04HD4128	65	S06H205	69	S07H420	70	S09H4305	72
S04HD4130	65	S06H206	69	S07H425	70	S09H4306	72
S04HD4132	65	S06H207	69	S07H427	70	S09H4307	72
S05A	Pág.	S06H208	69	S07H430	70	S09H4308	72
S05A408S	85	S06H210	69	S07H4320	71	S09H4309	72
S05A4H10	84	S06H211	69	S07H4325	71	S09H4310	72
S05A4H12	84	S06H306	69	S07H4327	71	S09H4312	72
S05A4H14	84	S06H307	69	S07H4330	71	S09H4314	72
S05A4H17	84	S06H308	69	S07H4340	71	S09H4316	72
S05A4H18	84	S06H310	69	S07H4345	71	S09H4317	72
S05A4H19	84	S06H311	69	S07H4350	71	S09H4319	72
S05A4H4	84	S06H312	69	S07H4352	71	S09V	Pág.
S05A4H5	84	S06H314	69	S07H4355	71	S09V3H4	118
S05A4H6	84	S06H316	69	S07H4360	71	S09V3H5	118
S05A4H7	84	S06H318	69	S07H4370	71	S09V3H6	118
S05A4H8	84	S06H320	69	S07H440	70	S09V3H8	118
S05A6105S	85	S06H320	69	S07H445	70	S09V41H10	118
S05A6H14	85	S06H37S	67	S07H450	70	S09V41H4	118
S05A6H17	85	S06H410	69	S07H4530	71	S09V41H5	118
S05A6H19	85	S06H411	69	S07H4540	71	S09V41H6	118
S05A6H22	85	S06H412	69	S07H4545	71	S09V41H8	118
S05A6H24	85	S06H4127S	60	S07H455	70	S10H	Pág.
S05H	Pág.	S06H414	69	S07H460	70	S10H230	72
S05H4113S	67	S06H416	69	S07H470	70	S10H235	72
S05H4213S	67	S06H418	69	S07H4932S	60	S10H240	72
S05HD4110	67	S06H420	69	S08H	Pág.	S10H245	72
S05HD	Pág.	S06H422	69	S08H208S	101	S10H250	72
S05HD4111	67	S06H424	69	S08H311S	71	S10H255	72
S05HD4112	67	S06H425S	59	S09H	Pág.	S10H260	72
S05HD4113	67	S06H427KV	38	S09H203	71	S10H270	72
S05HD4113S	67	S06H427SP	32	S09H204	71	S10H3100	73
S05HD4117	67	S06H49S	67	S09H205	71	S10H3120	73

S10H340	73	S18A	Pág.	S25V410	118	S49H4312	74
S10H350	73	S18A4103MS	86	S25V45	118	S49H4314	74
S10H355	73	S18A4115	86	S26H	Pág.	S49H4318	74
S10H360	73	S18A4117	86	S26H2150	77	S50H	Pág.
S10H370	73	S18A4117M	86	S26H2280	77	S50H3106S	74
S10H380	73	S18A4119	86	S27H	Pág.	S50H3206S	74
S10H4100	73	S18A4119M	86	S27H2	77	S54H	Pág.
S10H4110	73	S18A4121	86	S27H3	77	S54H5509S	74
S10H4120	73	S18A4121M	86	S27H4	77	S57H	Pág.
S10H480	73	S18AD	Pág.	S29H	Pág.	S57H108	53
S10H490	73	S18AD4117	86	S29H2133S	102	S57H108S	53
S11H	Pág.	S18AD4119	86	S29H2180S	105	S57H109	53
S11H200	73	S18AD4121	86	S29H4140SP	32	S57H110	53
S11H201	73	S21H	Pág.	S29H4141KV	38	S57H111	53
S11H202	73	S21H41125	76	S29T	Pág.	S57H112	53
S11H203	73	S21H41250	76	S29TP23S	102	S57H113	53
S11H300	73	S21H4150	76	S40H	Pág.	S57H115	53
S11H301	73	S21H4175	76	S40H108	77	S57H116	53
S11H302	73	S22H	Pág.	S40H110	77	S57H117	53
S11H303	73	S22H21130	76	S40H112	77	S57H118	53
S11H304	73	S22H21130RK	76	S40H114	77	S57H119	53
S11H402	73	S22H31200	76	S40T	Pág.	S57H121	53
S11H403	73	S22H41375	76	S40T108	77	S57H122	53
S11H404	73	S22H41375RK	76	S40T109S	77	S57H123	53
S12A	Pág.	S22H41450	76	S40T110	77	S57H124	53
S12A4525S	85	S22H41600	76	S40T112	77	S57H125	53
S14A4108S	102	S22H41600RK	76	S40T113	77	S57H127	53
S14A4117	102	S22H6500	76	S40T114	77	S57H132	53
S14A4118	102	S22H6500RK	76	S40T117	77	S60H	Pág.
S14A4120	102	S23H	Pág.	S40T119	77	S60H4304S	78
S14A4121	102	S23H21115	77	S41H	Pág.	S63H	Pág.
S14A4123	102	S23H31200	77	S41H41	77	S63H3306	74
S14A4124	102	S23H41250	77	S42M	Pág.	S63H3307	74
S14A4126	102	S23H41300	77	S42M403S	78	S63H3308	74
S14A4127	102	S23H6450	77	S42M4125	78	S63H3310	74
S15H	Pág.	S23H6500	77	S42M4250	78	S63H4306	74
S15H240	75	S23H8550	77	S42M475	78	S63H4307	74
S15H356	75	S24H	Pág.	S43V	Pág.	S63H4308	74
S15H472	75	S24H2100	77	S43V38	119	S63H4310	74
S15H6109	75	S24H2150	77	S43V48	119	S63H4312	74
S16H	Pág.	S24H250	77	S44H	Pág.	S63H4313	74
S16H1234	76	S24H3150	77	S44H2206	78	S63H4405	74
S16H1238	76	S24H3200	77	S44H3110A	78	S63H4405	74
S16H1438	76	S24H3250	77	S44H3206	78	S63H4407	74
S16H302	76	S24H375	77	S44H4110	78	S63H4407	74
S16H304	76	S24H4125	77	S46T	Pág.	S63H4408	74
S16H3410	76	S24H4224	77	S46TE80	87	S63H4408	74
S16H3412	76	S24H4250	77	S49H	Pág.	S63H4409	74
S16H3812	76	S24H450	77	S49H4105	74	S63H4409	74
S16H3814	76	S24H475	77	S49H4106	74	S63H4410	74
S16H403	76	S24H6100	77	S49H4108	74	S63H4410	74
S17H	Pág.	S24H6200	77	S49H4110	74	S63H4412	74
S17H3116	76	S24H6400	77	S49H4112	74	S63H4412	74
S17H3121	76	S24H8200	77	S49H4114	74	S63H4413	74
S17H3414	76	S25V	Pág.	S49H4116	74	S63H4413	74
S17H4116	76	S25V310	118	S49H4308	74	S63H4414	74
S17H4121	76	S25V36	118	S49H4310	74	S63H4414	74

S63H4507S	74	S64H4712	75	S68H2108	56	T21340N-R	45
S63H4605	74	S64H4714	75	S68H2109	56	T21341N	44
S63H4606	74	S64H4808	75	S68H2110	56	T21341N-R	45
S63H4607	74	S64H4810	75	S68H2111	56	T21550N	44
S63H4608	74	S64H4812	75	S68H2112	56	T21550N-R	45
S63H4609	74	S64H4814	75	S68H2113	56	T24	Pág.
S63H4610	74	S66H	Pág.	S68H2114	56	T24135	45
S63H4612	74	S66H4108	68	S68H2141S	56	T24135-R	45
S63H4613	74	S66H4110	68	S68H5234111S	57	T24200	45
S63H4614	74	S66H4111	68	T04	Pág.	T24200-R	45
S63H4708	75	S66H4112	68	T04M060-R	45	T25	Pág.
S63H4709	75	S66H4113	68	T04M061-R	45	T25100N	44
S63H4710	75	S66H4114	68	T04M150-R	45	T25100N-R	45
S63H4712	75	S66H4115	68	T04M250-R	45	T25200N	44
S63H4713	75	S66H4116	68	T07	Pág.	T25200N-R	45
S63H4714	75	S66H4117	68	T07030N-R	45	T25340N	44
S63H4808	75	S66H4118	68	T07110N-R	45	T25340N-R	45
S63H4809	75	S66H4119	68	T07700N-R	45	T27	Pág.
S63H4810	75	S66H4120	68	T09	Pág.	T27-D2R	45
S63H4812	75	S66H4121	68	T094602	47	T27-D3R	45
S63H4813	75	S66H4122	68	T094602-RK	47	T27-D4R1	45
S63H4814	75	S66H4124	68	T096801	47	T27-D4R2	45
S64A	Pág.	S66H4125	68	T096801-RK	47	T27-D6R	45
S64A4106S	85	S66H4126	68	T10	Pág.	T27-D8R	45
S64A6116	85	S66H4127	68	T102001S-R	45	T27010N	44
S64A6118	85	S66H4128	68	T10314	44	T27020N	44
S64A6306S	85	S66H4130	68	T10315	44	T27060N	44
S64A6T100	85	S66H4132	68	T10316	44	T271001N	44
S64A6T70	85	S66H4136	68	T10317	44	T27101N	44
S64A6T80	85	S66HD	Pág.	T10318	44	T27200N	44
S64A6T90	85	S66HD4110	68	T10319	44	T27340N	44
S64H	Pág.	S66HD4111	68	T10321	44	T27800N	44
S64H4104	75	S66HD4112	68	T10322	44	T29	Pág.
S64H4105	75	S66HD4113	68	T10H1210S	44	T29002	44
S64H4106	75	S66HD4114	68	T14	Pág.	T29014	44
S64H4107	75	S66HD4115	68	T14200N	45	T29016	44
S64H4109	75	S66HD4116	68	T15	Pág.	T30	Pág.
S64H4112	75	S66HD4117	68	T154100N-R	45	T30200NS	44
S64H4113	75	S66HD4118	68	T154200N-R	45	T31	Pág.
S64H4114	75	S66HD4119	68	T16	Pág.	T31313	44
S64H4126S	61	S66HD4120	68	T16005N-R	45	T31324	44
S64H4204	75	S66HD4121	68	T19	Pág.	T33	Pág.
S64H4205	75	S66HD4122	68	T19135N	45	T33025N	44
S64H4206	75	S66HD4123	68	T19200N	45	T33025N-R	45
S64H4207	75	S66HD4124	68	T19600N	45	T33050N	44
S64H4208	75	S66HD4127	68	T21	Pág.	T33050N-R	45
S64H4209	75	S66HD4130	68	T21025N	44	T33101N	44
S64H4210	75	S66HD4132	68	T21025N-R	45	T33101N-R	45
S64H4212	75	S68H	Pág.	T21050N	44	T33200N-R	45
S64H4214	75	S68H2103	56	T21050N-R	45	T33341N	44
S64H4216	75	S68H2104	56	T211000N	44	T33341N-R	45
S64H4218	75	S68H21045	56	T211000N-R	45	T35	Pág.
S64H4705	75	S68H2105	56	T21101N	44	T351060	47
S64H4706	75	S68H21055	56	T21101N-R	45	V10	Pág.
S64H4708	75	S68H2106	56	T21200N	44	V1001	92
S64H4709	75	S68H21065	56	T21200N-R	45	V1002	92
S64H4710	75	S68H2107	56	T21340N	44	V1002-RK	92

V1003	92	W232427	51	W251618	52	W26125	52
V1003-RK	92	W232528	51	W251719	52	W26126	52
V1005	92	W233032	51	W251819	52	W26126S	52
V11	Pág.	W23559SV	36	W251922	52	W26127	52
V11011SC	40	W23V108	119	W252022	52	W26128	52
V1103	92	W23V110	119	W252123	52	W26129	52
V13	Pág.	W23V111	119	W252224	52	W26130	52
V1310A-11	93	W23V112	119	W252426	52	W26132	52
V1310B-11	93	W23V113	119	W252427	52	W26134	52
V1310E-11	93	W23V114	119	W252528	52	W26134SV	36
V1310F	93	W23V116	119	W252730	52	W26136	52
V1310F-11	93	W23V117	119	W252732	52	W26138	52
V1310G-11	93	W23V118	119	W253032	52	W26141	52
V1310J-11	93	W23V119	119	W253236	52	W26142	52
V1311A	93	W23V121	119	W253641	52	W26144	52
V1311C	93	W23V122	119	W253842	52	W26146	52
V1311E	93	W23V124	119	W254146	52	W26148	52
V1311SP	33	W24	Pág.	W254650	52	W26150	52
V14	Pág.	W240809	51	W25V108	119	W26155	52
V1401	93	W241011	51	W25V109	119	W26160	52
V1403	93	W241012	51	W25V110	119	W26165	52
V15	Pág.	W24106S	51	W25V1125SV	119	W2623431SV	36
V1501	93	W241213	51	W25V113	119	W26315SV	36
V1505	93	W241214	51	W25V114	119	W26411PRS	53
V21	Pág.	W241314	51	W25V117	119	W26414S	53
V2101	92	W241417	51	W25V118	119	W27	Pág.
V2102	92	W241617	51	W25V119	119	W27AK8	55
V2102-RK	92	W241719	51	W25V121	119	W27AL10	55
V24	Pág.	W241819	51	W25V122	119	W27AR10	55
V2401	92	W241922	51	W25V124	119	W27AR8	55
V2401-M10A	93	W242224	51	W26	Pág.	W27AS10	55
V2401-M10B	93	W242427	51	W26106	52	W27AS15	55
V2401-M5A	93	W242528	51	W26107	52	W27AS18	55
V2401-M5B	93	W243032	51	W26108	52	W27AS8	55
V2401-M6A	93	W24A107S	48	W26108KV	39	W27AT02SC	40
V2401-M6B	93	W24A109SP	33	W26109	52	W27AT10	55
V2401-M8A	93	W24N0810	51	W26110	52	W27AT12	55
V2401-M8B	93	W24N1113	51	W26110KV	39	W27AT15	55
W23	Pág.	W24N1214	51	W26111	52	W27AT8	55
W230607	51	W24N1719	51	W26112	52	W28	Pág.
W230809	51	W25	Pág.	W26112S	52	W2808	56
W230810	51	W250607	52	W26112SP	33	W2810	56
W231011	51	W250608	52	W26113	52	W2810RJ-HL	56
W23108S	51	W250809	52	W26114	52	W2812	56
W23108SP	33	W251011	52	W26114S	52	W2812RJ-HL	56
W231113	51	W251012	52	W26115	52	W2814	56
W231213	51	W25106KV	38	W26116	52	W2814RJ-HL	56
W231317	51	W25107KV	38	W26116KV	39	W2818	56
W231415	51	W25108S	52	W26116SP	33	W2818RJ-HL	56
W231617	51	W25110KV	39	W26117	52	W2824	56
W231719	51	W25110SP	33	W26118	52	W2824RJ-HL	56
W231819	51	W25117SC	40	W26119	52	W2836	56
W231922	51	W251213	52	W26120	52	W2836RJ-HL	56
W232022	51	W251214	52	W26121	52	W28HD8	56
W232123	51	W251415	52	W26122	52	W29	Pág.
W232224	51	W251417	52	W26123	52	W290608	53
W232426	51	W251617	52	W26124	52	W290711	53

W291012	53	W61	Pág.	W67124	54	W77A155	54
W291418	53	W611011	50	W67130	54	W77A160	54
W291622	53	W61106S	50	W67132	54	W77A165	54
W292024	53	W611214	50	W67136	54	W77H01	54
W39	Pág.	W611315	50	W67138	54	W77H02	54
W391011	53	W611618	50	W67141	54	W77H03	54
W39108SA	53	W611719	50	W67145	54	W77H04	54
W391213	53	W612224	50	W67146	54	W84	Pág.
W391415	53	W62	Pág.	W67150	54	W84106	57
W391617	53	W6210607	50	W67155	54	W84107	57
W391819	53	W6210809	50	W67160	54	W84108	57
W43	Pág.	W62108S	51	W67165	54	W84108S	57
W43A0607	54	W6211011	50	W67170	54	W84109	57
W43A0809	54	W6211213	50	W68	Pág.	W84110	57
W43A1011	54	W6211415	50	W680809	49	W84111	57
W43A106S	54	W6211617	50	W680810	49	W84112	57
W43A1213	54	W6211819	50	W681011	49	W84113	57
W43A1415	54	W6212022	50	W68106S	49	W84114	57
W43A1617	54	W6212427	50	W681213	49	W84114S	57
W43A1819	54	W6212528	50	W681415	49	W84115	57
W45	Pág.	W6213032	50	W681618	49	W84116	57
W45108	48	W65	Pág.	W681719	49	W84117	57
W45109	48	W65105KV	39	W69	Pág.	W84118	57
W45110	48	W6510810	53	W69116S	53	W84119	57
W45110S	48	W6511012	53	W70	Pág.	W86112S	57
W45111	48	W6511315	53	W70A118S	33	W91	Pág.
W45112	48	W6511417	53	W72	Pág.	W91107S	50
W45112SP	33	W6511922	53	W72117	55	W91110	50
W45113	48	W65A1012	54	W72118	55	W91112	50
W45114	48	W65A105S	54	W72119	55	W91113	50
W45115	48	W65A1214	54	W72121	55	W91114	50
W45116	48	W65A1315	54	W72122	55	W91115	50
W45117	48	W65A1618	54	W72124	55	W91117	50
W45117S	48	W65A1719	54	W72127	55	W91119	50
W45118	48	W65A1922	54	W72130	55	W93	Pág.
W45119	48	W65A2224	54	W72132	55	W93108S	50
W45121	48	W66	Pág.	W72134	55	W93110	50
W45122	48	W66107S	49	W72136	55	W93111	50
W45124	48	W66108	49	W72141	55	W93112	50
W45127	48	W66109	49	W72146	55	W93113	50
W45130	48	W66110	49	W72150	55	W93114	50
W45132	48	W66111	49	W72155	55	W93115	50
W45316S	48	W66112	49	W72170	55	W93117	50
W45316S-AD	48	W66113	49	W73	Pág.	W93119	50
W45316S-AD12	48	W66114	49	W73102S	50	WFS	Pág.
W45316S-AD14	48	W66115	49	W7310813	49	WFS46	54
W45316S-AD34	48	W66116	49	W7311419	49	WV2	Pág.
W45316S-AD38	48	W66116S	49	W77	Pág.	WV27AS10	119
W45316S-ADBH14	48	W66117	49	W77A124	54		
W47	Pág.	W66118	49	W77A127	54		
W47108SP	33	W66119	49	W77A130	54		
W51	Pág.	W66121	49	W77A132	54		
W51110S	49	W66124	49	W77A136	54		
W52	Pág.	W67	Pág.	W77A138	54		
W52105S	49	W67104S	49	W77A141	54		
W60	Pág.	W67119	54	W77A146	54		
W60115SP	33	W67121	54	W77A150	54		

ARTÍCULO	PÁG.	ARTÍCULO	PÁG.
Accesorios para redes de aire comprimido	183 a 185	Cuña de chapista	158
Accesorios para carros de herramientas	24	Cuter/navaja	113
Agarre flexible magnético	127	Destornillador	159, 160
Alicate ajustable	88, 89, 91	Destornillador plano	96 a 100
Alicate anti-estático	91	Detetor de fugas cilindros	126
Alicate corta cables	91, 92	Embudo para aceites e refrigerante	140
Alicate de abrazaderas	143, 146	Enrollador para aire	183
Alicate de apriete de terminales	93	Esmeriladora recta neumática	171, 172
Alicate de bloqueo	93 a 95	Extensiones	76 a 78
Alicate de frenos	88, 89	Extensor en espiral para aire	184
Alicate de pelar	90, 93	Extractor barra de dirección	143
Alicate de rebitar	92	Extractor de inyectores	133
Alicate para segmentos	132	Extractor juntas de las válvulas	132
Alicate para tubos escape	143	Extractor para válvulas	132
Alicate para tubos radiador	146	Extractores	123 a 125
Alicate puntas curvas para anillos de seguridad	136	Filtros de aire	183, 184
Alicate tensor para abrazaderas de tubos	143	Flexómetro	113
Alicates (universal, puntas, corte)	88 a 90	Fresadora de puntos de soldadura	171
Alicates de frenos	142	Gambiarra	114
Alicates para tuberías	136, 141, 143, 146	Garra de chapista	159, 160
Amoladora neumática	172	Gato chapista	196
Armarios de oficinas	18 a 20	Gato de anchura/hidráulico	195
Atornilladora neumática	170, 171	Gato de foso/transmisiones	194
Balanzas	182	Gato hidráulico para chapistas	196
Banco de apoyo	195	Grapas de plástico	162
Bandeja magnética	127	Grua hidráulica	195
Barras para puertas	196	Herramienta aislada 1000Volts	115 a 117
Bolígrafo magnético	127	Herramienta ajuste eje trasero MB	143
Bomba de engrase	182	Herramienta chapista	156 a 160
Bomba hidropneumática	194	Herramienta para frenos	141, 142
Caballetes	122 e 196	Herramienta para montaje/desmontaje de correas	139, 140
Cable en "T" corredizo	77	Herramienta para pulir válvulas	135
Cables de arranque de la batería	146	Herramientas especiales mecánica	122 a 152
Cajas de herramientas	23	Herramientas especiales motocicletas	154 a 156
Calibre de espesores (galgas)	140	Herramientas especiales pesados	161, 162
Calibre lectura	113	Herramientas especiales por marca	147 a 152
Camilla para mecánico	195	Herramientas para quitar parabrisas	156
Cardán	75	Hidrómetro	145
Carros y cajas vacíos	20 a 23	Jeringa	126
Carros y composiciones de herramientas	7 a 17	Juego de llaves de vaso con trinquete	58, 59
Centrador de embrague	142	Juego de puntas	101, 102
Compás	114	Juego saca abolladuras	159
Compresor de grapas	125	Kit de calado de distribución motor	130, 147 a 152
Comprobación de inyectores	133	Kit para eliminación de radios	147
Comprobador de compresión/presión	132, 133, 146	Kit quita tapizados de plástico	156, 157
Comprobador de la altura de las zapatas de freno	142	Limas	112
Comprobador vacío/presión	135	Llave com trinquete	48 a 50
Corta tubos	143, 145	Llave de apriete angular	128
cuadrado de metal	113	Llave de bocas de perfil fino	53
Cuchilla neumática	179	Llave de estrella	50, 51, 54

ARTÍCULO	PÁG.	ARTÍCULO	PÁG.
Llave de filtros de aceite	136 a 139	Palanca de chapista	158
Llave de impacto	78 a 87	Palanca para desmontaje	144
Llave de mango exible con vaso	77	Pinza amperimétrica	197
Llave de vaso bujias	76, 139	Pistola de aire/agua	183
Llave dinamométrica	44 e 45	Pistola de pintura	176, 177
Llave flexible para tubos de combustible	136	Pistola tornado pulverizador	126
Llave inglesa	55	Porta bits	104
Llave mixta	52, 53	Porta terrajas	129
Llave para golpes (fijas y estrella)	54, 55	Prueba de presión para radiadores	122
Llave para polea alternador	131	Pulidor neumático	173, 174
Llave para sondas de oxígeno	139	Pulidor neumático de válvulas	178
Llave para tubos	56	Pulidora de cilindros	144, 145
Llave quita grapas	157, 158	Pulidora neumática	173 a 178
Llaves allen en "L"	105 a 109	Puntas para válvulas neumáticas	127
Llaves de cruz para tuercas de ruedas	128	Puntas y porta puntas	101 a 105
Llaves de pipa	53	Punzones	111, 112
Llaves de vaso	63 a 69	Racor	184, 185
Llaves de vaso bujias incandescência	134	Raspadores/ rascadores	135
Llaves en T de punta flexible	77	Recogedora de aceites	122 e 197
Llaves fijas	52	Reducciones	76
Llaves para inyectores	133, 134	Refratómetro	126
Llaves para tapones de aceite	136, 138, 140	Regla	113
Llaves para terminales	131	Regla de vericación de deformación del motor	129
Llaves Phillips	96 a 100	Remachadora neumática	181, 182
Llaves pie de gallo	78	Reparación de "roscas"	140, 141, 143
Llaves Pozi	98 a 100	Saca casquillos	127
Llaves quita tuercas dañadas	102, 133 e 145	Sacas	123 a 125
Llaves SuperTech	56, 57	Sangrador liquido frenos	123, 135
Llaves Torx	97, 98	Sierra	113
Llaves Torx em "L"	106 a 109	Sierra neumática	178, 179
Llaves Torx Plus	99	Soporte de motores	195
Machos y terrajas	28, 39, 128, 129	Soporte llaves de vaso	75
Maleta de electricista	145	Soporte para mover neumáticos/ruedas	195
Maleta de herramientas	61, 62	Tableros herramientas (caja plástico)	28 a 33 e 39 a 40
Mango articulado	76	Tableros herramientas (EVA)	34 a 39
Mango para llaves de vaso	77	Tableros vacíos	41 a 43
Máquina neumática de decapar	179	Taladradora neumática	169, 170
Máquina neumática de impacto	164 a 167	TAS de cuña	158, 159
Martillo neumático	181	Tenazas	91
Martillos	110	Test de atuadores	146
Martillos de chapista	158	Test de sistemas turbo	134
Medidor de discos de freno	144	Test fluido de frenos	146
Medidor de paso de rosca	128	Tijera	91
Medidor de presión pneus	127	Tijera neumática	180
Medidor de profundidad	144	Tornillo de banco	25
Merchandising	188, 191	Travesaño para soporte de motores	195, 196
Mesas de trabajo	197	Trinquete neumático	168, 169
Micrómetro	114	Trinquetes	45 a 47
Multímetros	197	Vasos de puntas	69 a 75
Organizador de piezas	131	Ventosas	157



No utilizar con herramientas neumáticas llaves de vaso u otras herramientas de uso manual. Utilice llaves de vaso de impacto y sus accesorios.



No utilizar martillos o tubos para aumentar el torque en llaves de ajuste, llaves dinamométricas y trinquetes.



No utilice destornilladores como palanca, cortafríos o punzones. Existen herramientas especiales para esos casos.

Herramienta Manual

- Deberá tener mucho cuidado en la utilización de cualquier herramienta, manteniéndolas alejadas de los niños.
- Se recomienda la utilización de gafas y guantes de protección y de protecciones en los oídos (si aplicable).
- Deberá desconectar siempre la corriente antes de realizar cualquier tipo de manejo en las superficies conductivas, para evitar descargas eléctricas. En estos casos, utilice siempre herramientas aislantes.
- Deberá elegir el género y tamaño correcto de la herramienta manual para el trabajo a realizar. Las unidades de medida sirven para seleccionar la herramienta con el tamaño correcto.
- Deberá mantener las herramientas limpias.
- Deberá leer las instrucciones antes de utilizar las herramientas.
- No deberá cambiar ninguna herramienta.
- Sólo abra un cajón cada vez, así evitará la posibilidad de volcar el carro de herramientas.
- Nunca deberá usar un cajón como escalera (peligro de volcar el carro de herramientas).
- No deberá tirar del carro de herramientas de espaldas.

Herramienta Neumática

Las herramientas neumáticas JONNESWAY permite a sus operadores disfrutar de un uso seguro, una gran fiabilidad y la reducción casi total de las vibraciones en sus tareas diarias. Las medidas de seguridad que detallamos incluyen las posibilidades o condiciones que pueden ocurrir durante su uso. Antes de utilizar herramientas neumáticas, deberá leer atentamente estas advertencias para evitar riesgos innecesarios.

- **Elementos de protección personal**
Para evitar lesiones, se recomienda la utilización de máscaras, gafas, auriculares y guantes de protección siempre que se manejan herramientas neumáticas.
- **Prevención de daños causados por vibraciones o movimientos repetitivos**
La exposición prolongada a vibraciones o movimientos repetitivos de trabajo puede ser perjudicial. Cuando se siente hormigueo, entumecimiento, malestar o dolor, se debe dejar de usar la herramienta. Los operadores deberán seguir siempre las siguientes instrucciones:
 - Utilice siempre los mangos y asas para evitar accidentes y garantizar el buen uso de los equipos.
 - Mantenga las muñecas lo más recto posible.
 - Evite movimientos repetitivos de las manos y muñecas.
 - Mantenga las manos y el cuerpo secos y calientes.
 - Evite la exposición continua y prolongada a vibraciones muy prolongadas.



- **Evitar los peligros del aire comprimido**
- El aire comprimido puede causar daños o lesiones. Tenga en cuenta las siguientes medidas de seguridad para garantizar un entorno de trabajo más seguro.
- Nunca apunte el tubo de aire hacia usted o hacia otros. Todas las personas en el taller deberán permanecer lejos del escape de aire.
- Antes de utilizar la herramienta neumática, deberá controlar el estado de las tuberías y accesorios del sistema neumático.
- Deberá apagar y desconectar la herramienta cuando no esté en uso, cuando cambie accesorios, o cuando se hacen reparaciones.
- Deberá mantener siempre la presión del aire en el rango apropiado. El uso de herramientas fuera de estos valores disminuirá su rendimiento y vida útil de la herramienta.
- No conecte aparatos de aire a tomas de corriente.
- Cuando se utilicen conectores universales, deberán ser siempre instalados toques horquilla de bloqueo para evitar que las tuberías se desconecten accidentalmente.

- **Evitar riesgos adicionales**
- Resbalones, tropezones y caídas son la principal causa de lesiones y muertes en accidentes de trabajo! Deberá tener cuidado con los tubos y cables en la área de trabajo.
- Los operadores y técnicos de mantenimiento deben ser físicamente capaces de realizar sus tareas y soportar el volumen, peso y potencia de la herramienta.
- Cuando opere con una esmeriladora o tronzadora deberá utilizar pantalla de protección para reducir el riesgo de cortes y abrasiones debido a los materiales que puedan saltar.

Sistema Neumático de alimentación

- ① Filtro
- ② Drenaje
- ③ Secador de Aire
- ④ Depósito de Aire
- ⑤ Compresor de Aire
- ⑥ Filtro Regulador - Lubricante

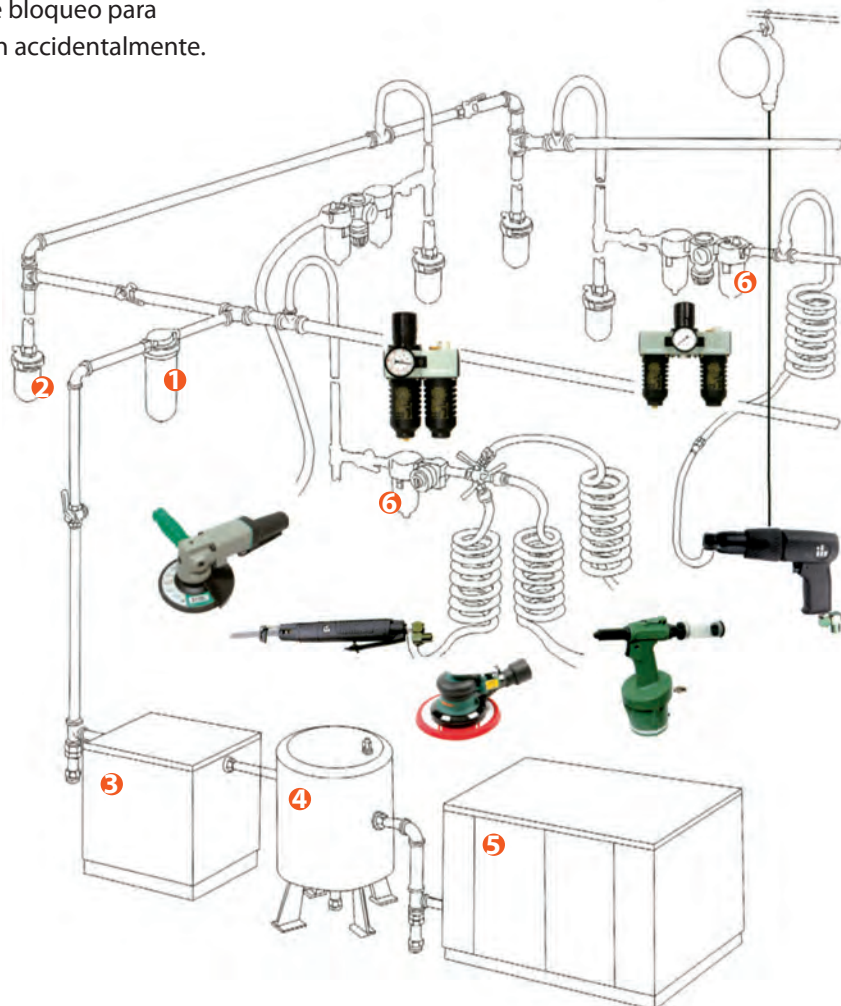

Recomendaciones de mantenimiento

Al conectar la herramienta neumática a la red de aire comprimido, deberá asegurarse de que la presión en esta es de 6.2kg/cm² (90 psi). Si la presión en la red de aire comprimido es demasiado alta puede dañar la herramienta o si es demasiado bajo influirán el funcionamiento de la misma y reducirá su vida útil.

- Se recomienda la instalación de filtros reguladores lubricadores adecuados a la herramienta en uso. La entrada de aire debe tener aceite lubricante apropiado, para lubricar el motor interno de la herramienta. (Coloque un papel blanco en la salida de aire para ver si hay contaminación con aceite, lo que indica que hay suficiente petróleo).
- La toma de aire no debe tener agua. Si esto ocurre, se recomienda comprobar o instalar un secador de aire.
- No se deberá desmontar la herramienta, ya que puede dañar y afectar la seguridad del usuario.
- Incluso si la herramienta tiene daños menores o no realice las funciones especificadas por el fabricante, no se debe utilizar hasta que sea inspeccionada.
- Para mantener el funcionamiento de la herramienta, deberá realizar controles periódicos (cada semana), mantenimiento preventivo y lubricaciones (engrasar las piezas giratorias y añadir aceite lubricante al motor).
- Al utilizar herramientas neumáticas deberá cumplir con las instrucciones de seguridad y de uso.
- Es esencial elegir las herramientas adecuadas para el trabajo por hacer, ya que si la herramienta tiene una potencia muy alta, puede dañar la pieza que está trabajando o si tienen poco poder, puede dañar la propia herramienta.

Términos de la garantía

La herramienta manual y neumática Jonnesway es fabricada con los más altos estándares de calidad, pero para todos los efectos, son herramientas que se desgastan con el uso. Por tanto, es normal ese desgaste, incluso cuando la herramienta se utiliza en condiciones normales. De este modo, la garantía de la herramienta depende de todas las condiciones siguientes:

- Para herramientas de mano se les ofrece una garantía de "vida útil", garantía que cubre defectos en materiales y mano de obra. Se entiende por "vida útil" el período de vida esperable para la herramienta en cuestión, cuando se utiliza en condiciones normales de uso y para los fines para que fue diseñada.
- La gama de herramientas neumáticas y instrumentos de medición se excluyen del punto 1. Los productos están diseñados y fabricados para el uso profesional. El período de garantía es de un año (12 meses) para el uso profesional y dos años (24 meses) para uso privado. El período de garantía comienza en la fecha de adquisición. Esta fecha debe ser verificada en la factura de compra.
- Cualquier producto que se ha utilizado o mantenido incorrectamente, que ha sufrido el desgaste debido al uso incorrecto o ha sido objeto de modificaciones no autorizadas, no está cubierto por la garantía.
- La falta de mantenimiento preventivo o la utilización de presión de aire comprimido y lubricación inadecuada es motivo de pérdida de la garantía.



JONNESWAY



Certificate TW07/03277

The management system of

JONNESWAY ENTERPRISE CO., LTD.

6F 9, No. 51, Sec. 2, Keelung Rd., Taipei City

has been assessed and certified as meeting the requirements of

ISO 9001:2015

For the following activities

Design and trading management of JONNESWAY brand of professional hand tools, pneumatic tools, automobile repair tools, garage equipment and working machines.

This certificate is valid from 14 February 2019 until 14 February 2022 and remains valid subject to satisfactory surveillance audits. Recertification audit due a minimum of 90 days before the expiration date. Issue 5. Certified since 14 February 2007

Authorised by



SGS United Kingdom Ltd
Reference Business Park, Eldonwatts Park, Cheshire, CH83 2JX, UK
t +44 (0)191 380 6936 f +44 (0)191 380 6900 www.sgs.com
HC SGS 9001 2015 0818

Page 1 of 1







This document is issued by the Company subject to the General Conditions of Certification Services, available at www.sgs.com, and constitutes the Agreement between the Company and the Client. The Client is responsible for the maintenance of the equipment and for the fulfilment of the requirements of the standard. The Client is also responsible for the maintenance of the equipment and for the fulfilment of the requirements of the standard. Any modification, deletion, copying or falsification of the content is prohibited. If the document is printed and obtained, it may be printed in the Client's name.



JONNESWAY®

Herramientas Profesionales



CARROS, ARMÁRIOS Y
COMPOSICIONES



HERRAMIENTA MANUAL
PARA USO GENERAL



HERRAMIENTA AISLADA 1 000V



HERRAMIENTA DE
MECÁNICA



HERRAMIENTA PARA
VEHÍCULOS PESADOS



HERRAMIENTA ESPECIAL
PARA MOTOCICLETAS



HERRAMIENTA PARA
CARROCERÍA Y PINTURA



HERRAMIENTA NEUMÁTICA



Importador para España, Francia, Portugal, Angola y Cabo Verde



Lusilectra
Salvador Caetano

Rua Engº Ferreira Dias, 953/993 • 4100-247 Porto • Portugal
Tel. +351 226 198 750 • Email. lusilectra@lusilectra.pt
www.lusilectra.com • www.jonneswaytools.com

Distribuidor

