

► *VelyenPremium*

4EE0300A

Double Scissor Lift 3.500 Kg

Low profile: 10 cm · Automatic bleeding

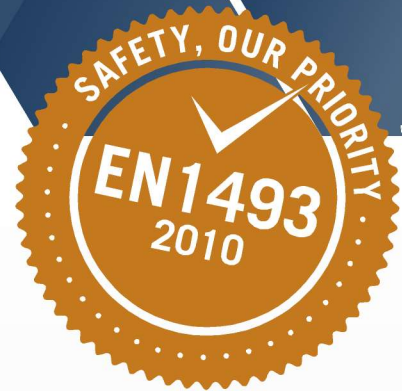



General Features:

- Product homologated and certified according to the new European Machinery Directive 2006/42/CE and Harmonized Norm EN 1493:2010.
- Strong structure of 4 cylinders to ensure two independent oil circuits: hydraulic safety.
- Low profile platforms are suitable for special or tuned vehicles.
- Suitable for surface or in-ground installation.
- The automatic bleeding of hydraulic circuits can be done easily by the operator without any type of technical assistance.
- Equipped with safety valve against over-pressure.
- Hydraulic system with safety device against unexpected uneven of platforms.
- Automatic safety stop at 300 mm from the floor and throughout the whole descent the lift will beep warning.
- High quality sliders guarantee a soft and stable lifting and lowering movement.
- Free maintenance self-lubricating bushings.
- Pushbuttons at 24V, type "dead man"
- Separated UP & DOWN pushbuttons and general switch lockable with padlock.
- Insolated ON/OFF switch · Safety system against obstacles on the lowering

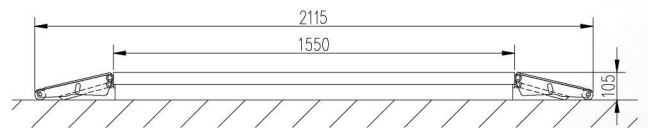
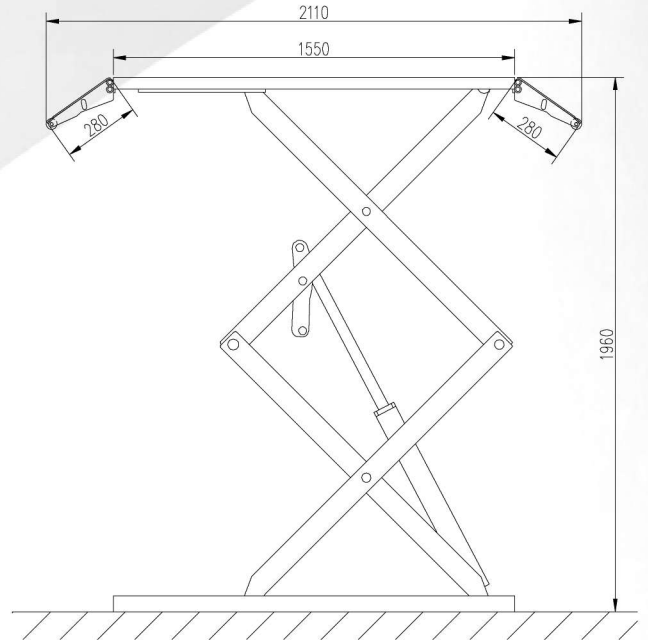

Load Capacity	3.500 Kg.
Platforms Length	Min/max 1.550-2.115 mm
Platforms Width	635 mm.
Drive on height	105 mm
Maximum Lifting Height	1.960 mm
Distance between platforms	720 mm
Overall Length	2.115 mm
Overall Width	1.990 mm.
Motor	3 Phase 230/400 V - 50/60 Hz. 2.2 KW



CUSTOM DESIGN AND MANUFACTURE BY VELYEN

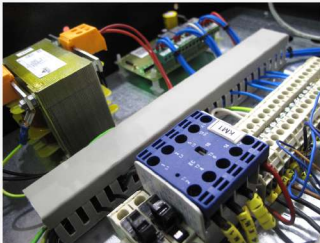

► ELECTRIC

Electrical components CE of the leading brands



► ELECTRIC

Optimized motor for high 120 performance with low 80 power consumption



► ELECTRIC

Non-contact proximity inductive limit switches

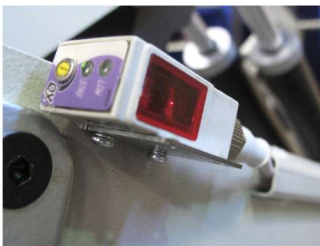

► ELECTRICAL SAFETY

Adjustable photocell maximum safety 100 mm



► HYDRAULIC

Automatic bleeding can be done easily by the end user without technical assistance



► HYDRAULIC

4 Cylinders hard pressed chrome of high quality, anti-corrosion designed and functionality tested



► HYDRAULIC

High pressure flexible hoses of double pressed mesh of high quality and fully tested

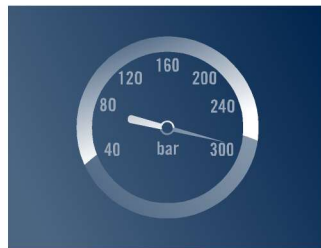

► HYDRAULIC

Hydraulic group of high performance (300bar) and long-life



► HYDRAULIC

Hydraulic O'rings Premium maximum sealing and minimal wear

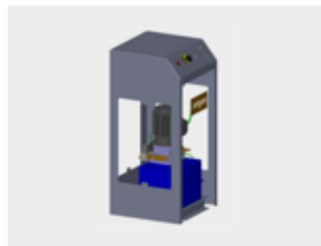

► HYDRAULIC

Integrated control box pre-installed



► DESIGN

Self-lubricating bushings



► DESIGN

No need compressed air supply



CUSTOM DESIGN AND MANUFACTURE BY VELYEN

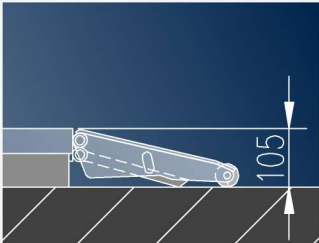

DESIGN
Minimum height design



SAFETY
Dynamic load test with 115% of the maximum load rate according to UNE 1493. Complete check of principal safety devices of the lift before delivery from factory



OPTIONALS / DESIGN
Surface or in-ground installation



SAFETY
Acoustic signal against toe-trapping

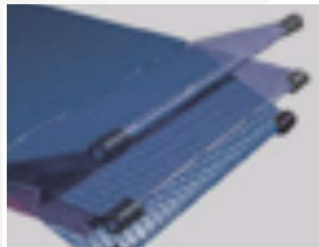

DESIGN
Reinforced folding ramps, act as platform length extensions



OPTIONALS
Optional 4 x 4



OPTIONALS
Color customization



DESIGN/ SAFETY
Two independent oil circuits with 4 cylinders to increase safety at work

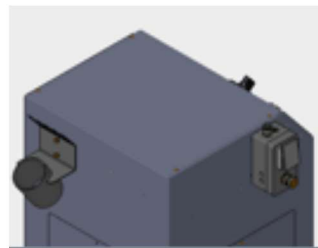

OPTIONALS
Tools support
Air & Energy supply



ACCESSORIES
Extra-low pads Included

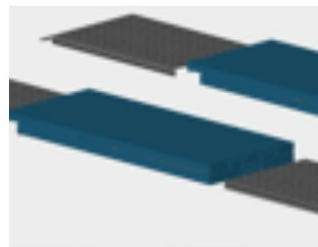

OPTIONALS
Special tuning optional

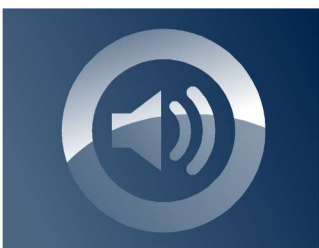

SAFETY
Reduced noise <65dB complying with the rules EN1493



OPTIONALS / ELECTRIC
Single phase version available